

RUBIX

eVOX PLATFORM INCLUDED |  INCLUDED

300M SERIES

IE2-IE3

Modular planetary gearboxes

 **Bonfiglioli**



Chapter	Description	Page	Chapter	Description	Page
GENERAL INFORMATION			NEGATIVE MULTIDISC BRAKE AND HYDRAULIC MOTORS		
		2			476
1	Symbols and units of measure	2	H1	Symbols and units of measure	476
2	Introduction	4	H2	Negative multidisc brake	476
3	Allowed temperature limits	4	H3	Inputs for hydraulic motors	477
4	Specifications	5	H4	Hydraulic motors	487
5	Versions	6	H5	Technical features	487
6	Output torque	8	H6	Designation	488
7	Power	9	H7	Displacement selection	489
8	Efficiency	10	H8	Checking	489
9	Reduction ratio	10	H9	Technical data MG motors	490
10	Angular speed	10	H10	Dimensions MG motors	492
11	Service factor	10	H11	Technical databrakes for MG motors	493
12	Service factor requested by application	11	H12	Installation	493
13	Life factor	11	PLANETARYM GEARBOX SERIES 300M ATEX CONFIGURATION		
14	Product selection	12			496
15	Installation	30	A1	Scope of document	496
16	Lubrication	32	A2	Introduction to the atex directives	496
17	Storage	34	A3	Use, installation and maintenance	498
18	Supply conditions	35	A4	Peculiarities of 300M series gear units compliant with directive Atex	498
SERIES 300M MODULAR PLANETARY GEARBOXES			A5	Ordering numbers	506
		36	A6	Declaration of conformity	510
19	300M Gearbox designation	36	ELECTRIC MOTORS		
20	3/V_M Gearbox designation	38			512
21	3/A Gearbox designation	40	M1	Symbols and units of measurement	512
22	Motor designation	42	M2	Introduction	513
23	Additional Options	43	M3	General characteristics	515
24	Mounting position	45	M4	Motor designation	517
25	Rating charts	49	M5	Variants and options	521
26	Dimensions	262	M6	Mechanical features	523
CUSTOMER'S SHAFT			M7	Electrical characteristics	528
		472	M8	Asynchronous brake motors	540
TORQUE ARM			M9	DC BRAKE MOTORS TYPE BXN-BX-BE-BN_FD AND MXN-MX-ME-M_FD	541
		475	M10	AC BRAKE MOTORS TYPE BXN-BX-BE-BN_FA AND MXN-MX-ME-M_FA	547
TORQUE ARM KIT FOR FP VERSIONS			M11	Brake release systems	551
		475	M12	Options	553
			M13	Tables of motors correlation	567
			M14	Motor rating charts BXN-MXN	570
			M15	Motors dimensions BXN-MXN	572
			M16	Motor rating charts BX-MX	576
			M17	Motors dimensions BX-MX	583
			M18	Motor rating charts BE-ME	591
			M19	Motors dimensions BE-ME	605
			M20	Motor rating charts BN-M	609
			M21	Motors dimensions BN-M	626

Revisions

Refer to page 632 for the catalogue revision index. Visit www.bonfiglioli.com to search for catalogues with up-to-date revisions.



1 SYMBOLS AND UNITS OF MEASURE

Symbols	Units of Measure	Description	Symbols	Units of Measure	Description
$A_{c1,2}$	[N]	Calculated thrust load	p	[bar]	Hydraulic oil pressure
$A_{n1,2}$	[N]	Rated thrust load	P_1	[kW]	Max transmissible power at gearbox input
A_{r2}	[N]	Thrust load at gearbox output shaft	P_1'	[kW]	Transmitted power at gearbox input
F_h	–	Lifetime factor for gearbox calculation	P_2	[kW]	Transmitted power at gearbox output
$F_{h1,2}$	–	Lifetime factor for bearing calculation	P_n	[kW]	Motor rated power
$f_{n1,2}$	–	Speed factor referred to input and output shaft loading	P_{r1}	[kW]	Required input power
f_L	–	Lifetime factor	P_{r2}	[kW]	Output power at n_2 max
f_m	–	Increase factor	P_{r2}'	[kW]	Output power at n_2 min
$f_{h1,2}$	–	Load corrective factor on shafts	P_S	[kW]	Excess power
f_S	–	Service factor	P_T	[kW]	Gearbox thermal capacity
f_S'	–	Service factor required by the application	Q	[l/min]	Hydraulic flow rate
f_t	–	Thermal factor	$R_{c1,2}$	[N]	Calculated radial load
f_v	–	Speed factor	$R_{n1,2}$	[N]	Rated radial load at shaft mid-point
h	[h]	Lifetime in hours	$R_{x1,2}$	[N]	Rated radial load at gearbox re-calculated with respect to different load application points
i	–	Reduction ratio	t_a	[°C]	Ambient temperature
K_a	–	Axial load duty factor	t_s	[°C]	Surface temperature
K_r	–	Radial load factor	t_o	[°C]	Oil temperature
l	–	Intermittence factor	V	[cm ³]	Hydraulic motor displacement
M_2	[Nm]	Torque delivered to output shaft	V_c	[cm ³]	(Theoretical) Hydraulic motor displacement
M_{c2}	[Nm]	Calculated torque at gearbox output	X	[mm]	Load application distance from shaft shoulder
M_{2REF}	[Nm]	Reference torque	η_d	–	Dynamic efficiency
M_{n2}	[Nm]	Gearbox rated output torque	Z	–	Frequency of starts
M_{2max}	[Nm]	Gearbox max. output torque			
M_b	[Nm]	Rated brake torque			
$M_{r1,2}$	[Nm]	Required torque at gearbox			
$n_{1,2}$	[min ⁻¹]	Angular speed			

1 value applies to input shaft
2 value applies to output shaft



Symbol referring to weight of gearboxes.



The number associated with the wrench symbol indicates the tightening torque for friction coupling screws.

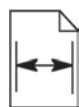

Columns marked with this symbol indicate the reference page showing dimensions.



Negative multidisc brake.



This symbol identifies reference page number.



Hydraulic motor connection.



DANGER - WARNING
This symbol indicates situations of danger, which if ignored, may result in serious injury to the operator.



Cover for standard input flanging.



IMPORTANT
This symbol indicates important technical information.



Inline units.



Right angle units.



Apply to equipment complying with "ATEX" Directive



Worm-planetary combined design.

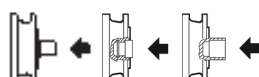

These symbols identify the mounting positions of accessories.



Bevel helical-planetary combined design.



These symbols identify the position of gearbox input (black-filled areas).





2 INTRODUCTION

This catalogue presents BONFIGLIOLI RIDOTTORI's range of Series 300M modular planetary gearboxes. The range has been expanded and integrated with new sizes, technical improvements and enhanced modularity right through to the larger sizes. This feature signifies greater flexibility in internal production to ensure quick availability of products in the sizes and types requested either directly from the company or from the many affiliates belonging to the BONFIGLIOLI sales network in various countries around the world.

The gearboxes are tested in conformity with the following standards:

ISO 6336 : 2006 - method B for gears

ISO 281 for bearings

DIN 743 : 2012 for shafts

3 ALLOWED TEMPERATURE LIMITS

Symbols	Description / Condition	Value (*)	
		Synthetic Oil	Mineral Oil
t_a	Ambient temperature		
$t_{au \text{ min}}$	Minimum operating ambient temperature	-30°C	-10°C
$t_{au \text{ Max}}$	Maximum operating ambient temperature	+50°C	+40°C
$t_{as \text{ min}}$	Minimum storage ambient temperature	-40°C	-10°C
$t_{as \text{ Max}}$	Maximum storage ambient temperature	+50°C	+50°C
t_s	Surface temperature		
$t_{s \text{ min}}$	Minimum gearbox surface temperature starting with partial load (#)	-25°C	-10°C
$t_{sc \text{ min}}$	Minimum gearbox surface temperature starting with full load	-10°C	-5°C
$t_{s \text{ Max}}$	Maximum casing surface temperature during continuous operation (measured next to the gearbox input)	+100°C	+100°C (@)
t_o	Oil temperature		
$t_{o \text{ Max}}$	Maximum oil temperature during continuous operation	+95°C	+95°C (@)

(*) = Refer to the table "Selection of the optimal oil viscosity" for further information about minimum and maximum values of different oil viscosity and for using hydraulic circuits. For values of $t_a < -20^\circ\text{C}$ and $t_s, t_o > 80^\circ\text{C}$, choose (as permitted in the product configuration stage) the sealing type of the most suitable material to the type of application. If needed contact Bonfiglioli Technical Service. 

(@) = Continuous operation it is not advised if t_s and t_o range is 80°C to 95°C .

(#) = For full load start-up it is recommended to ramp-up and provide for greater absorption of the motor. If needed, contact Bonfiglioli Technical Service. 



4 SPECIFICATIONS

The 300M series consist of a range of multi-purpose planetary gearboxes that can be operated by either hydraulic or electric motors. Basic features are:

- 20 frame sizes of modular design
- output torque up to 1.286.700 Nm
- transmissible power up to 1050 kW
- ratios from 3,4:1 to 5234:1
- versions:
 - in-line with 1 to 4 reductions
 - right angle (spiral bevel gear set into first stage) with 2 to 4 reductions
- combinations with:
 - worm gear units
 - bevel-helical gear units
- flange, foot and shaft mounting arrangements
- slow output shafts: keyed, splined male, splined hollow, shrink disk mounted
- input adaptors for:
 - IEC-normalised electric motors
 - integral motor for in-line units up to size 307 and for units combined with bevel helical and worm gears
 - hydraulic motors by major manufacturers and according to SAE J744C
- parallel input shafts
- gearmotors with:
 - electric motors IEC
 - hydraulic orbital motors by BONFIGLIOLI TRASMITAL MG
- negative hydraulic parking brakes for operation by hydraulic motors
- output shaft accessories:
 - flanges
 - pinions
 - splined bars
 - shrink discs

More design features:

- high ratio of transmissible torque to overall dimensions
- high overhung and axial load capacity due to heavy duty tapered roller bearings featured on H and P versions
- high efficiency
- inner parts are coupled through splined connections rather than keys
- planetary gears mounted onto self-centering carriers to ensure the most even load distribution among planetary gears
- housing made of spheroidal cast iron.

Configurations

(A 1)

Configuration	Power	Torque	Ratios	Efficiency	Noise level
	$0.25 \leq P_n \text{ [kW]} \leq 55$	$M_{2REF} \leq 1286700 \text{ Nm}$	$3.4 \leq i \leq 2916$	High	Medium
	$0.25 \leq P_n \text{ [kW]} \leq 55$	$M_{2REF} \leq 656000 \text{ Nm}$	$7 \leq i \leq 953$	High	Medium
	$0.12 \leq P_n \text{ [kW]} \leq 22$	$M_{2REF} \leq 656000 \text{ Nm}$	$370 \leq i \leq 5234$	Medium	Low
	$0.12 \leq P_n \text{ [kW]} \leq 22$	$M_{2REF} \leq 15680 \text{ Nm}$	$18.7 \leq i \leq 731$	High	Low



5 VERSIONS

A INPUT

B REDUCTIONS

A

- 1 Orbital hydraulic motor
MG with/without brake
- 2 Hydraulic motor
- 3 Hydraulic motor setting
- 4 Cover
- 5 Negative brake
- 6 Compact electric motor
- 7 IEC electric motor
- 8 Electric motor setting
- 9 Electric motor connection
with integrated fan
- 10 Input shaft
- 11 Solid input shaft
with fan

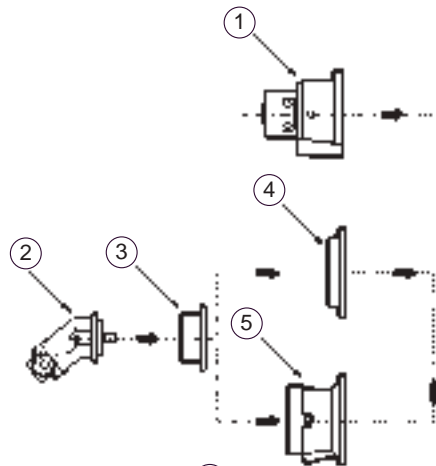

B

- 12 Right-angle reduction stage
- 13 Single planetary reduction stage
- 14 Two or more planetary reduction stages
- 15 Planetary reduction combined
with wormgear unit
- 16 Planetary reduction stage
combined with helical bevel
gear unit

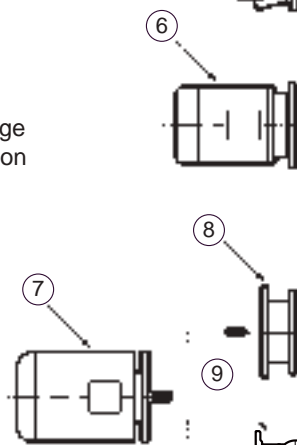

C

- 17 **MC/MZ** - Keyed or splined solid shaft
output
- 18 **HC/HZ** - Keyed or splined heavy
duty solid output shaft
- 19 **PC/PZ** - Output with support bracket
and keyed or splined solid shaft
- 20 **FZ** - Splined hollow output shaft
- 21 **FP** - Hollow output shaft for
shrink disc
- 22 **HC** - Parallel solid output shaft
- 23 **HZ** - Splined solid output shaft
- 24 **FZ** - Splined hollow output shaft
- 25 **FP** - Hollow output shaft
for shrink disc
- 26 **PC** - Foot mount
- 27 **VK** - Reinforced output with parallel
shaft for stirrers and mixers
- 28 **FDK** - Hollow shaft with double
keyway
- 29 **FZP** - Hollow splined shaft with axial
blockage device



D

- 30 **WOA** - Flange
- 31 **P_** - Pinion
- 32 **MOA** - Sleeve coupling

- 33 End plate
- 34 **B0A** - Splined bar
- 35 **G0A** - Shrink disc



C OUTPUT

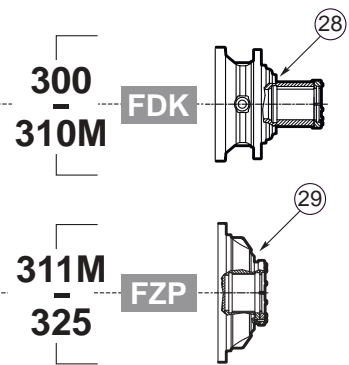
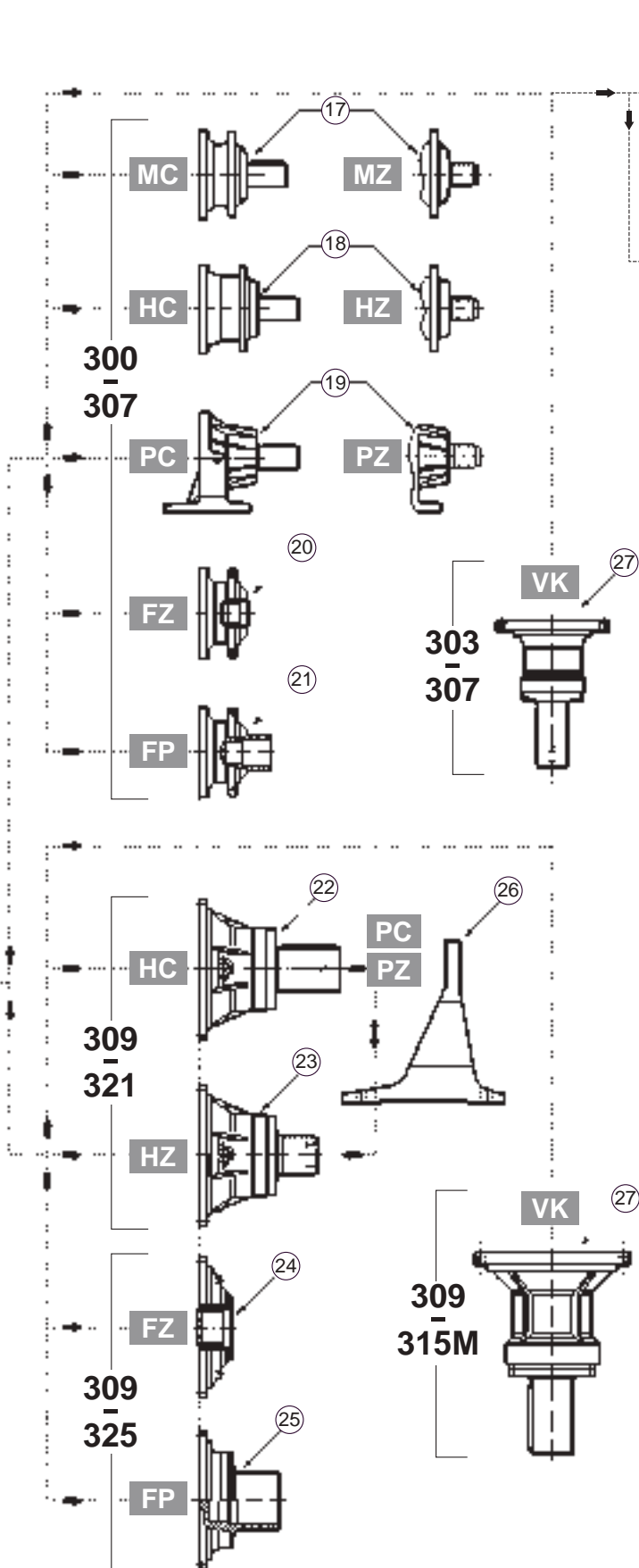

D FITTINGS

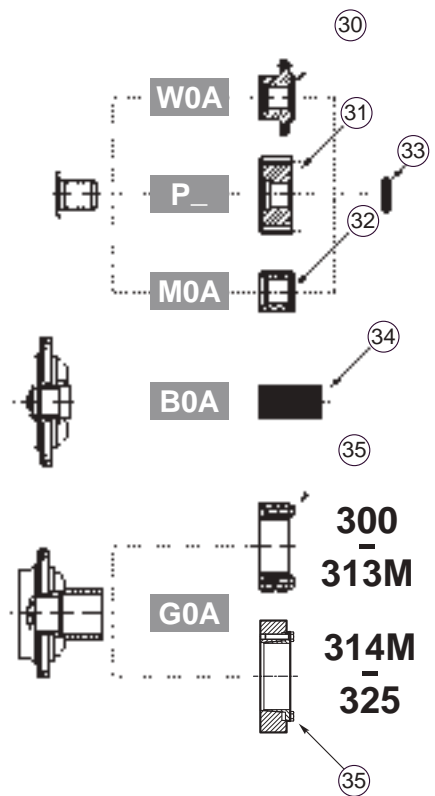



GENERAL INFORMATION

The following paragraphs contain information on essential elements for selection and correct use of gearmotors.

6 OUTPUT TORQUE

(A 2)

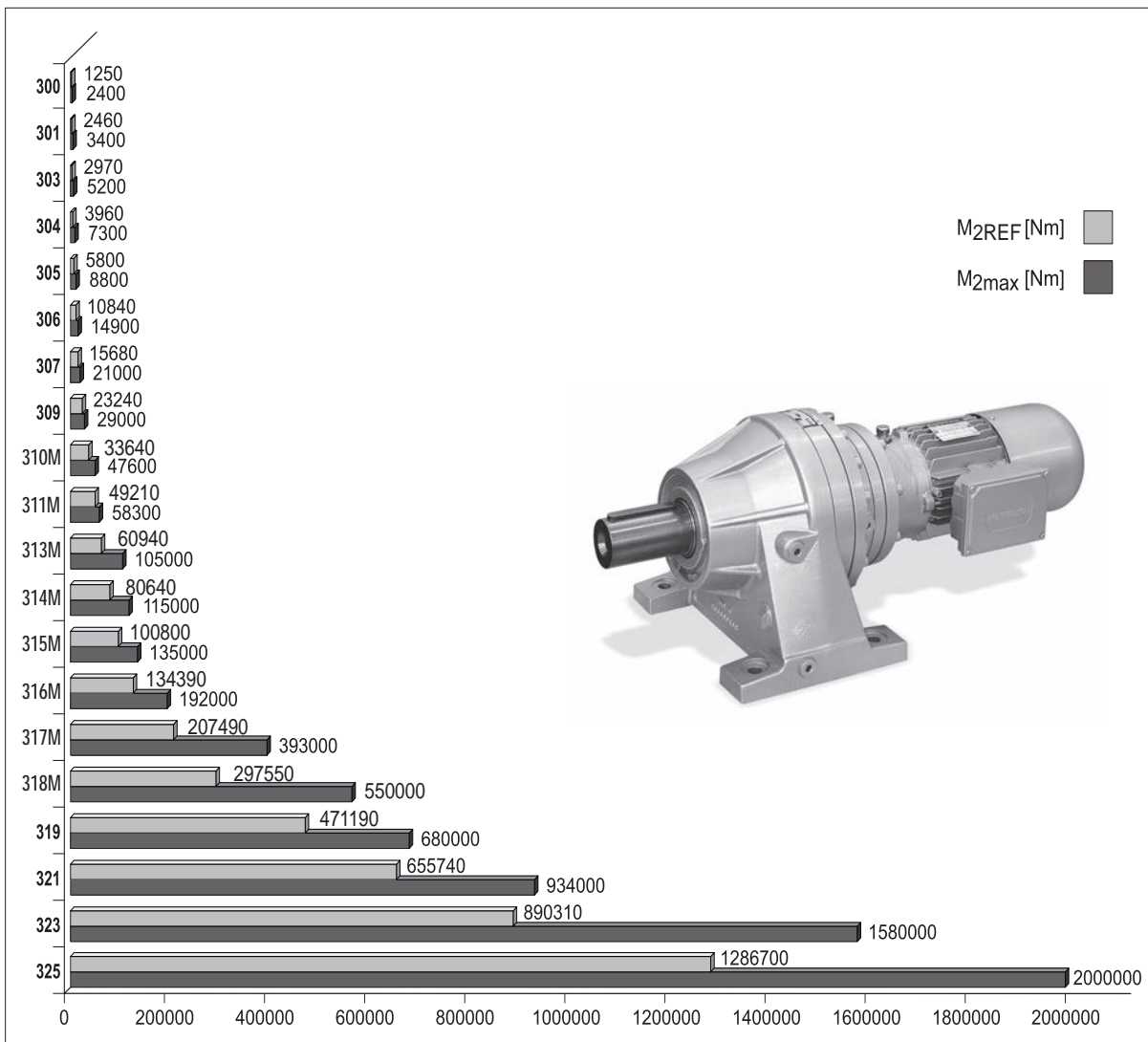

6.1 Reference torque M_{2REF} [Nm]

It is the significant value for the size. It is equivalent to the maximum value of nominal torque M_{n2} for a life factor $n_2 \times h = 10000$ (referred to single stage configuration L1).

6.2 Rated output torque M_{n2} [Nm]

It is the output torque which the gearbox can transmit with steady load under working condition specified in the calculation method.



6.3 Maximum torque M_{2max} [Nm]

It is the output torque that the gearbox can withstand under static or almost static conditions. It is generally meant as a momentary peak load or starting-up torque under load.
The values in the tables are valid only in versions with output splined shaft (accessories excluded).

6.4 Required torque M_{r2} [Nm]

The torque drawn by the application. It must always be equal to or less than rated output torque M_{n2} for the gearbox under study.

7 POWER

7.1 Input rated power P_{n1} [kW]

P_{n1} is the maximum power that can be safely applied to the gearbox when the same is operated:
- at a n_1 drive speed
- yielding a theoretical lifetime of 10000 hours
- service factor $f_s=1$

Check that the formula here below is always satisfied:

$$P_1' \times f_s \leq P_1 \quad (1)$$

7.2 Output power P_2 [kW]

This value is the net power delivered to the output shaft.
It can be calculated through the following formulas:

Efficiency values are listed in table (A3).

$$P_2 = P_1 \times \eta_d \quad (2)$$

$$P_2 = \frac{M_{r2} \times n_2}{9550} \quad (3)$$

7.3 Thermal power P_T [kW]

This parameter is linked to the gearbox thermal limit (see par. 14.5).



8 EFFICIENCY

8.1 Dynamic efficiency η_d

The parameter is defined as the relationship of the net power delivered to the output shaft P_2 to the power applied to the input shaft P_1 :

$$\eta_d = \frac{P_2}{P_1} \quad (4)$$

Indicative values for the efficiency are listed in the chart here after.

(A 3)

No. of reductions	Configuration		
	Planetary	Combined with worm gear unit	Combined with right-angle unit
1	0.97	—	—
2	0.94	0.73	—
3	0.91	0.70	0.91
4	0.88	—	—

9 REDUCTION RATIO i

It is defined as the relationship of the speed the input shaft is driven at and the speed delivered at the output shaft of a gearbox.

$$i = \frac{n_1}{n_2} \quad (5)$$

10 ANGULAR SPEED

10.1 Input speed n_1 [min⁻¹]

The speed the gearbox is driven at.

The value is coincident with the motor speed if this is directly connected to the gearbox. Input speed should never exceed the n_{1max} value listed in the gearbox rating chart.

10.2 Output speed n_2 [min⁻¹]

It is calculated from drive speed n_1 and gear ratio i , as per the following equation:

$$n_2 = \frac{n_1}{i} \quad (6)$$

11 SERVICE FACTOR f_s

This is the relationship of the gear unit rated power to the power of the electric motor actually driving the unit.

$$f_s = \frac{P_{n1}}{P_1} \quad (7)$$



12 SERVICE FACTOR REQUESTED BY APPLICATION f_s'

It's a coefficient that represents the severity of the application. This factor takes into account, although approximately, the type of load the gearbox operates with, the specific duty cycle as well as the operating daily hours.

The table (A4) is of reference when determining the appropriate service factor for the application.

(A 4)

Service factor f_s' required depending on the application						
Type of load	Number of starts/hour z	Total operating hours (h)				
		≤ 5000	10000	15000	25000	50000
		Daily operating hours (h)				
		$h < 4$	$4 < h < 8$	$8 < h < 12$	$12 < h < 16$	$16 < h < 24$
Uniform load	$Z < 10$	0.90	1.00	1.15	1.30	1.60
	$10 < Z < 30$	0.95	1.15	1.30	1.50	1.80
	$30 < Z < 100$	1.00	1.25	1.45	1.60	2.00
Moderate shock load	$Z < 10$	1.00	1.25	1.45	1.60	2.00
	$10 < Z < 30$	1.10	1.40	1.60	1.80	2.20
	$30 < Z < 100$	1.20	1.50	1.70	2.00	2.40
Heavy shock load	$Z < 10$	1.20	1.50	1.70	2.00	2.40
	$10 < Z < 30$	1.30	1.60	1.80	2.10	2.60
	$30 < Z < 100$	1.40	1.75	2.00	2.30	2.80

13 LIFE FACTOR F_{h1} , F_{h2}

Factor resulting by multiplying angular speed at input (n_1) or output (n_2) by actual operating working hours h , break times excluded.

$$F_{h1} = (n_1 \times h) \quad (8)$$

$$F_{h2} = (n_2 \times h) \quad (9)$$

Life factor is directly proportional to gearbox rpms during the whole duty time



14 PRODUCT SELECTION

Bonfiglioli Forever Forward		TECHNICAL DATA REQUIRED FOR THE SELECTION OF 300M				Nr:
						Date:
						Rev_
						Date:
A) GENERAL DATA						
#	1	Company / Customer				
#	2	Contact				
#	3	Branch / Distributor				
#	4	Order quantity				
#	5	Delivery time				
B₁) ELECTRIC MOTOR			B₂) HYDRAULIC MOTOR			
#	6	Motor Type				
#	7	P _{n1} Rated motor Power	[kW]	V	Displacement	[cm ³]
#	8	P _{r1} Motor power demand	[kW]	Δp	Max drop of pressure	[bar]
#	9	n ₁ Input speed	[min ⁻¹]	Q	Max oil flow rate	[l/min]
#	10	Pole number				
#	11	Motor mounting: B3 - B5 - B14				
C₁) PLANETARY GEARBOX			C₂) ATEX CONDITION [GROUP II] -2014/34/EU			
#	12	Gearbox configuration				
#	13	i Gear ratio	Category: [2=standard / 3=special]			
#	14	n ₂ Output speed	[min ⁻¹]	Atmosphere: [G=gas / D=dust]		
#	15	M _{r2} Output torque demand	[Nm]	Zone: [1 - 21 / 2 - 22]		
#	16	M _{p2} Peak torque demand	[Nm]	Temperature Class [T4 / 135 °C]		
#	17	f _s Service factor demand				
#	18	Rotation of the output shaft [frontal view]:	CW		CCW	
#	19	L _{10H} Bearings lifetime	[h]			
#	20	Gears lifetime	[h]			
#	21	SF _{min} Safety for tooth root stress	standard reference (ISO preferred)			
#	22	SH _{min} Safety for flank pressure	standard reference (ISO preferred)			
D) ADDITIONAL LOADS						
#	23	R _{c2} Radial load on output shaft	[N]			
#	24	x ₂ Load application distance from shaft shoulder	[mm]			
#	26	R _{c1} Radial load on input shaft	[N]			
#	27	x ₁ Load application distance from shaft shoulder	[mm]			
#	29	A _{n2} Thrust load on output shaft (+ / -)	[N]			
#	30	A _{n1} Thrust load on input shaft (+ / -)	[N]			
E) APPLICATION						
#	31	Type of application				
#	32	Duty cycle	Time phase %	Time phase hours	Gearbox output torque [Nm]	Gearbox output speed [min ⁻¹]
			****	****		
			****	****		
			****	****		
			****	****		
			****	****		
#	33	Notes about Duty Cycle:				
		Duty type	S1	S2	S3	S4-S8
#	34	v _A Ambient air velocity	[m/s]	≤ 0.5	> 0.5 ≤ 1.4	> 1.4
#	35	t _a Ambient temperature range	[°C]			
#	36	Altitude a.s.l.	[m]			
#	37	Rating according FEM class	T-	L-	M-	
F) OPTIONS OR ADDITIONAL REQUESTS						
#	38	Lubrication				
#	39	Supplementary cooling systems				
#	40	Paint coating				
#	41	To specific requests for testing				
G) NOTES						
#	42	Notes and additional Customer requirements:				
#	43	PLP number if present for Special Gearbox				

Mandatory for the selection

The form, duly filled in, can be forwarded to our Technical Service which will assist the Customer in selecting the most suitable drive for the specific application.



14.1 PRODUCT SELECTION GUIDE

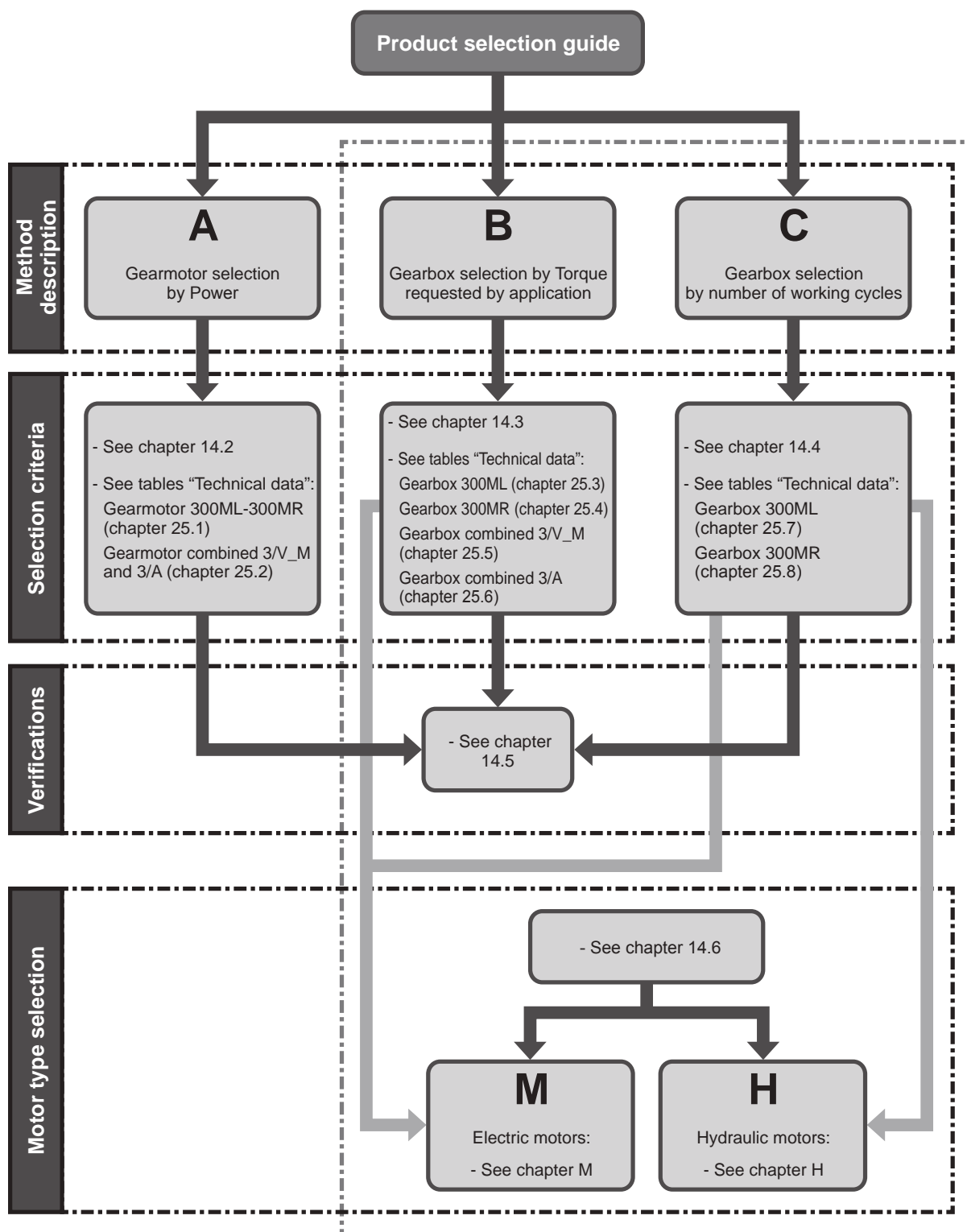

NOTE:

The selection criteria and specifications reported in this catalogue are not valid for every and each application, including those where the gearbox operates as a safety device preventing injury to persons or damage to objects, as is the case with hoisting equipment.

For these applications, the gearbox should be selected according to specific criteria and in compliance with the applicable safety regulations. Should this be the case we recommend that you seek advice from BONFIGLIOLI Technical Service.



For the selection of gear units in ATEX configuration, see also the specific chapter on page 486.

14.2 METHOD A (Gearbox selection by power)

Based on application type, it should be defined :

a) Required service factor f_S' (see tab A4);

b) Required drive power:

$$P_{r1} = \frac{M_{r2} \times n_2}{9550 \times \eta_d} \quad (10)$$

Table (A3) lists the indicative values of efficiency η_d for the different types of gearboxes.

c) After required power P_{r1} and output speed n_2 are known, locate the gearmotor rating charts and select the one relevant to normalized power P_n equal to or greater than P_{r1} :

$$P_n \geq P_{r1} \quad (11)$$

Unless otherwise specified, power P_n listed in the motor rating chart refers to continuous duty S1. For motors operating in conditions other than S1, determine type of duty according to CEI 2-3/IEC 60034-1 standards. Note that for duty cycles from S2 to S8 and motor frame sizes up to 132 included, power may be upgraded over that specified for continuous duty. In this event, the condition to be verified is the following:

$$P_n = \frac{P_{r1}}{f_m} \quad (12)$$

The adjusting factor f_m can be obtained from table (A5).

(A 5)

	DUTY						Please contact us
	S2			S3*			
	Cycle duration			Cyclic duration factor			
	10	30	60	25%	40%	60%	
f_m	1.35	1.15	1.05	1.25	1.15	1.1	

* Cycle time must be equal to or less than 10 minutes. Should this not be the case contact our Technical Service for assistance.

Cyclic duration rate is the relationship of operating time under load t_r to total cycle time ($t_f + t_r$) where t_f is time at rest, expressed as a percentage.

Cyclic duration rate:

$$I = \frac{t_r}{t_f + t_r} \times 100 \quad (13)$$



For the output speed n_2 , or closest to, select the gearmotor that yields a service factor f_S meeting the following condition:

$$f_S \geq f_S' \quad (14)$$



In case of **FP** configuration, please see Verification paragraph (chapter 14.5 - item g) .

14.3 METHOD B (Gearbox selection by Torque requested by application)

Based on application type, it should be defined :

a) Required service factor f_S' (see tab A4);

b) Determine calculated torque according to required output torque M_{r2} as follows:

$$M_{c2} = M_{r2} \times f_S' \quad (15)$$

c) Determine gear ratio from required output speed n_2 and drive speed n_1 :

$$i = \frac{n_1}{n_2} \quad (16)$$

d) Once M_{c2} and i are determined, locate the gearbox rating chart for the drive speed n_1 and select a gearbox featuring the ratio i nearest to calculated ratio that also satisfies the condition:

$$M_{n2} \geq M_{c2} \quad (17)$$

If a IEC-normalised motor is to be fitted onto the gearbox, check availability of the applicable adapter.



In case of **FP** configuration, please see Verification paragraph (chapter 14.5 - item g) .

14.4 METHOD C (Gearbox selection by number of working cycles)

a) Determine the following according to the required application:

- Required service factor f_S' (see tab. A4)
- required gearbox working life h
- required drive unit (hydraulic, electric or others).

b) Define the calculated torque with the required output torque M_{r2} :

$$M_{c2} = M_{r2} \times f_S' \quad (18)$$

c) Calculate the life factor with required working life h and output speed n_2 :

$$Fh_2 = (n_2 \times h) \quad (19)$$



d) Calculate the required reduction ratio:

$$i = \frac{n_1}{n_2} \quad (20)$$

e) Select gearbox size which, having a reduction ratio close to the calculated value, which satisfies the following

$$M_{c2} \leq M_{n2} \quad (21)$$

$$Fh_2 \leq (n_2 \times h) \quad (22)$$

where M_{n2} and Fh_2 are indicated in the tables on technical features for each gearbox size.

In case of applications in which the required torque M_{r2} and speed n_2 vary within a wide range, best selection could be an equivalent required torque given by:

$$M_{r2} = \sqrt[4]{\frac{(n_2 \times h)_A \times M_A^4 + (n_2 \times h)_B \times M_B^4 + (n_2 \times h)_C \times M_C^4 + \dots}{(n_2 \times h)_A + (n_2 \times h)_B + (n_2 \times h)_C + \dots}} \quad (23)$$

referred to:

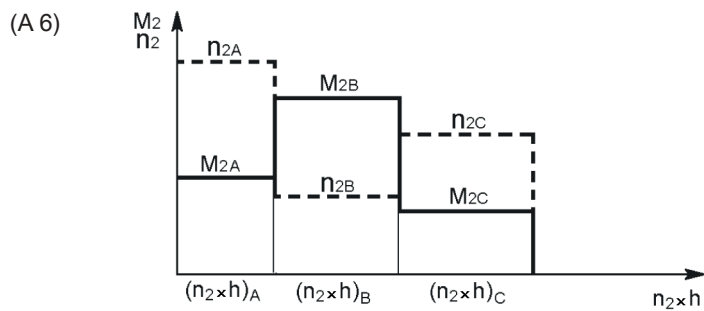

and calculating the life factor Fh with:

$$Fh_{calc} = (n_2 \times h)_A + (n_2 \times h)_B + (n_2 \times h)_C + \dots \quad (24)$$

Then follow the same procedure as specified in d) and e).



In case of **FP** configuration, please see Verification paragraph (chapter 14.5 - item g) .



14.5 VERIFICATION

After selecting the drive units, please check the following:

a) Thermal power

The thermal power P_T is the maximum power that the gearbox can transmit mechanically, under continuous operation, without the internal temperature rising to a value that could damage the gearbox components.

Base thermal capacities values P_{TB} are listed in section C and calculated under the following operating conditions:

- Input speed 1500 min⁻¹ (some exceptions)
- Ambient temperature 20°C
- Foot base with splined or solid keyed shaft
- Horizontal mounting position (A, B, E, F, G, I, J, M)
- Installation in large area (air speed > 1.4 m/s)
- Continuous duty
- Max. installation altitude 1000 m
- Oil ISO VG 320

They are valid for a specific size and gearbox ratio.

Please refer to Bonfiglioli Technical Service:

- For L1 gearbox configuration
- For R2 gearbox configuration, size > 307

Otherwise, for a specific configuration, the total thermal power P_T can be calculated using the following formula:

$$P_T = P_{TB} \times f_{out} \times f_{Tamb} \times f_{speed} \times f_{pos} \times f_{input V} \times f_{air} \times f_{id} \times f_{nb} \quad (25)$$

Where:

P_T = overall thermal power

P_{TB} = Base thermal power

f_{out} = factor depends on output version

f_{Tamb} = factor for ambient temperature 40°C

f_{speed} = factor for specific input speed (1800, 1200, 1000 min⁻¹)

f_{pos} = factor for vertical mounting position (T, O, Q, V)

$f_{input V}$ = factor for solid input shaft if present (apply only for size ≥ 309)

f_{air} = factor for installation in confined space (air speed ≤ 1.4 m/s)

f_{id} = factor for intermittent duty

f_{nb} = factor for negative multidisc brake (if present)

The specific factors are listed in the tables below.

The total thermal power obtained from this calculation must be greater than the P_{r1} (required input power).

$$P_T \geq P_{r1} \quad (26)$$

For specific configuration or application data different from the standard, please refer to Bonfiglioli Technical Service.



(A 7)

(L)	f _{out}				
	L2		L3		L4
300	i ≤ 20.1	i > 20.1			
	0.68	0.75	0.75	0.91	
FZ/FP/HC/ HZ/MC/MZ/ FDK	0.68	0.75	0.75	0.91	
PZ/PC	1.00	1.00	1.00	1.00	
301	L2		L3		L4
	i ≤ 20.1	i > 20.1	i ≤ 116	i > 116	
FZ/FP/HC/ HZ/MC/MZ/ FDK	0.65	0.70	0.78	0.80	0.97
PZ/PC	1.00		1.00	1.00	
303	L2		L3		L4
	0.82		0.84		0.81
FZ/FP/HC/ HZ/MC/MZ/ FDK	0.82		0.84		0.81
PZ/PC	1.00		—		
304	L2		L3		L4
	0.83		0.83		0.79
FZ/FP/HC/ HZ/MC/MZ/ FDK	0.83		0.83		0.79
PZ/PC	1.00		1.00		1.00
305	L2		L3		L4
	0.80		0.80		0.78
FZ/FP/HC/ HZ/MC/MZ/ FDK	0.80		0.80		0.78
PZ/PC	1.00		1.00		1.00
306	L2		L3		L4
	i ≤ 26.4	i > 26.4			
FZ/FP/HC/ HZ/MC/MZ/ FDK	0.70	0.75	0.72	0.75	
PZ/PC	1.00	1.00	1.00	1.00	
307	L2		L3		L4
	i ≤ 28.0	i > 28.0			
FZ/FP/HC/ HZ/MC/MZ/ FDK	0.77	0.81	0.80	0.81	
PZ/PC	1.00	1.00	1.00	1.00	
309	L2		L3		L4
	i ≤ 17.4 (i = 12.3)* (i = 14.7)*	i > 17.4			
FZ/FP/HC/ HZ/MC/MZ/ FDK	0.37	0.50	0.52	0.55	
PZ/PC	1.00	1.00	1.00	1.00	
310M	L2		L3		L4
	i ≤ 21.8 (i = 14.7)*	i > 21.8			
FZ/FP/HC/ HZ/FDK	0.40	0.50	0.59	0.61	
PZ/PC	1.00	1.00	1.00	1.00	
311M	L2		L3		L4
	i ≤ 21.5	i > 21.5			
FZ/FP/HC/ HZ/FZP	0.40	0.42	0.50	0.60	
PZ/PC	1.00	1.00	1.00	1.00	

(L)	f _{out}				
	L2		L3		L4
313M			i ≤ 92.4	i > 92.4	
	*		0.43	0.55	0.60
FZ/FP/HC/ HZ/FZP	*		0.43	0.55	0.60
PZ/PC	1.00		1.00		1.00
314M	L2		L3		L4
			i ≤ 73.9	i > 73.9	
FP/HC/HZ/ FZP	*		0.45	0.50	0.65
FZ	*		0.30	0.44	0.52
PZ/PC	1.00		1.00		1.00
315M	L2		L3		L4
	i ≤ 22.3	i > 22.3 n ₁ ≤ 1200 rpm			
FP/HC/HZ/ FZP	*	0.47	0.46	0.50	
FZ	*	0.38	0.37	0.40	
PZ/PC	1.00	1.00	1.00	1.00	
316M	L2		L3		L4
			i ≤ 114	i > 114	
FZ/FP/HC/ HZ/FZP	*		0.45	0.50	0.60
PZ/PC	1.00		1.00		1.00
317M	L2		L3		L4
	i ≥ 22.1 n ₁ = 900 rpm		i ≤ 69.3	i > 69.3	
FZ/FP/HC/ HZ/FZP	*		*	0.60	0.65
PZ/PC	1.00		1.00	1.00	1.00
318M	L2		L3		L4
	n ₁ = 500 rpm		i ≤ 98.2	i > 98.2	
FZ/FP/HC/ HZ/FZP	0.55		*	0.50	0.57
PZ/PC	1.00		1.00	1.00	1.00
319	L2		L3		L4
	n ₁ = 500 rpm		i = 84.8, 100, 126	i = 109 i > 126	
FZ/FP/HC/ HZ/FZP	0.60		*	0.55	0.64
PZ/PC	1.00		1.00	1.00	1.00
321	—		L3		L4
			i ≤ 98.2	i > 98.2	i ≤ 308 i > 308
FZ/FP/HC/ HZ/FZP	—		0.51	0.60	0.50 0.56
PZ/PC	—		1.00	1.00	1.00 1.00
323	—		L3		L4
			1.00		1.00
FZ/FP/HC/ HZ/FZP	—		1.00		1.00
325	—		L3		L4
			1.00		1.00
FZ/FP/HC/ HZ/FZP	—		1.00		1.00

* BONFIGLIOLI
TECHNICAL SERVICE



(A 8)

(R)	f _{out}		
	R2	R3	R4
300	R2	R3	R4
FZ/FP/HC/HZ/ MC/MZ/FDK	0.85	0.90	0.92
PZ/PC	1.00	1.00	1.00
301	R2	R3	R4
FZ/FP/HC/HZ/ MC/MZ/FDK	0.80	0.83	0.87
PZ/PC	1.00	1.00	1.00
303	R2	R3	R4
FZ/FP/HC/HZ/ MC/MZ/FDK	0.88	0.91	0.95
PZ/PC	1.00	1.00	1.00
304	R2	R3	R4
FZ/FP/HC/HZ/ MC/MZ/FDK	0.88	0.91	0.95
PZ/PC	1.00	1.00	1.00
305	R2	R3	R4
FZ/FP/HC/HZ/ MC/MZ/FDK	0.86	0.93	0.97
PZ/PC	1.00	1.00	1.00
306	R2	R3	R4
FZ/FP/HC/HZ/ MC/MZ/FDK	0.88	0.90	0.90
PZ/PC	1.00	1.00	1.00
307	—	R3	R4
FZ/FP/HC/HZ/ MC/MZ/FDK	—	0.78	0.81
PZ/PC	—	1.00	1.00
309	—	R3	R4
FZ/FP/HC/HZ/ MC/MZ/FDK	—	0.53	0.58
PZ/PC	—	1.00	1.00
310M	—	R3	R4
FZ/FP/HC/HZ/ FDK	—	0.55	0.60
PZ/PC	—	1.00	1.00
311M	—	R3	R4
FZ/FP/HC/HZ/ FZP	—	0.45	0.55
PZ/PC	—	1.00	1.00

(R)	f _{out}		
	—	R3	R4
313M	—	R3	R4
FZ/FP/HC/HZ/ FZP	—	0.45	0.60
PZ/PC	—	1.00	1.00
314M	—	R3	R4
FZ/FP/HC/HZ/ FZP	—	*	0.60
PZ/PC	—	1.00	1.00
315M	—	R3	R4
FZ/FP/HC/HZ/ FZP	—	*	0.50
PZ/PC	—	1.00	1.00
316M	—	R3	R4
FZ/FP/HC/HZ/ FZP	—	*	0.55
PZ/PC	—	1.00	1.00
317M	—	R3	R4
FZ/FP/HC/HZ/ FZP	—	*	0.65
PZ/PC	—	1.00	1.00
318M	—	—	R4
FZ/FP/HC/HZ/ FZP	—	—	*
PZ/PC	—	—	1.00
319	—	—	R4
FZ/FP/HC/HZ/ FZP	—	—	0.60
PZ/PC	—	—	1.00
321	—	—	R4
FZ/FP/HC/HZ/ FZP	—	—	0.58
PZ/PC	—	—	1.00

*  BONFIGLIOLI
TECHNICAL SERVICE



(A 9)

(L)	f _{Tamb}				
	L2		L3		L4
300	i ≤ 20.1	i > 20.1	i ≤ 116	i > 116	0.75
	0.64	0.72	0.66	0.72	
301	i ≤ 20.1	i > 20.1	i ≤ 116	i > 116	0.75
	0.64	0.75	0.68	0.75	
303	i ≤ 12.5	i > 12.5			0.75
	0.58	0.68	0.65		
304	i ≤ 22.7	i > 22.7	i ≤ 90.2	i > 90.2	0.75
	0.63	0.69	0.66	0.70	
305	i ≤ 26.4	i > 26.4	i ≤ 125	i > 125	0.75
	0.63	0.66	0.65	0.70	
306	i ≤ 26.4	i > 26.4			0.75
	0.60	0.70	0.70		
307	i ≤ 28.0 (i = 12.3)* (i = 14.7)*	i > 28.0			0.75
	0.65	0.68	0.70		
309	i ≤ 17.4 (i = 12.3)* (i = 14.7)*	i > 17.4			0.75
	0.6	0.65	0.73		
310M	i ≤ 21.8 (i = 14.7)*	i > 21.8			0.75
	0.60	0.65	0.72		

(L)	f _{Tamb}				
	L2		L3		L4
311M	i ≤ 21.5	i > 21.5	i ≤ 89.3	i > 89.3	0.75
	*	0.60	0.63	0.72	
313M	L2		L3		0.75
	i ≥ 21.8		i ≤ 92.4	i > 92.4	
	0.47		0.65	0.70	
314M	L2		L3		0.75
	i ≥ 22.3		i ≤ 73.9	i > 73.9	
	0.58		0.65	0.72	
315M	L2		L3		0.75
	i ≤ 22.3	i > 22.3	i ≤ 108	i > 108	
	*	0.47	0.64	0.71	
316M	L2		L3		0.75
	i ≤ 21.8	i > 21.8	i ≤ 114	i > 114	
	*	0.60	0.62	0.65	
317M	L2		L3		0.75
	i ≥ 22.1 n ₁ = 1000 rpm		i ≤ 69.3	i > 69.3	
	0.50		0.50	0.65	
318M	L2		L3		0.60
	n ₁ = 500 rpm		i ≤ 98.2	i > 98.2	
	0.60		0.60	0.60	
319	L2		L3		0.65
	n ₁ = 500 rpm		i ≤ 126	i > 126	
	0.55		0.60	0.65	
321	—		L3		0.70
	—		0.6		
323	—		L3		0.65
	—		0.6		
323	—		L3		0.65
	—		0.6		

* BONFIGLIOLI TECHNICAL SERVICE

(A 10)

(R)	f _{Tamb}		
	R2	R3	R4
300	0.65	0.70	0.70
301	0.65	0.70	0.70
303	0.62	0.66	0.70
304	0.60	0.65	0.67
305	0.63	0.65	0.68
306	0.63	0.68	0.70
307	—	R3	R4
	—	0.65	0.69
309	—	R3	R4
	—	0.67	0.70
310M	—	R3	R4
	—	0.65	0.68
311M	—	R3	R4
	—	0.60	0.70

(R)	f _{Tamb}		
	R3	R4	
313M	—	R3	R4
	—	0.63	0.70
314M	—	R3	R4
	—	0.55	0.60
315M	—	R3	R4
	—	0.65	0.70
316M	—	R3	R4
	—	0.60	0.65
317M	—	R3	R4
	—	0.60	0.65
318M	—	—	R4
	—	—	0.60
319	—	—	R4
	—	—	0.60
321	—	—	R4
	—	—	0.60

* BONFIGLIOLI TECHNICAL SERVICE



(A 11)

(L)	f _{speed}			
	L2		L3	L4
300	i ≤ 20.1	i > 20.1		
n ₁ = 1800 rpm	0.80	0.95	0.95	0.95
n ₁ = 1200 rpm	1.10	1.03	1.02	1.02
n ₁ = 1000 rpm	1.30	1.05	1.05	1.05
301	L2		L3	L4
	i ≤ 20.1	i > 20.1		
n ₁ = 1800 rpm	0.80	0.95	0.95	0.95
n ₁ = 1200 rpm	1.12	1.03	1.02	1.02
n ₁ = 1000 rpm	1.30	1.10	1.10	1.10
303	L2		L3	L4
	i ≤ 20.8	i > 20.8		
n ₁ = 1800 rpm	0.80	0.95	0.95	0.95
n ₁ = 1200 rpm	1.03	1.02	1.02	1.02
n ₁ = 1000 rpm	1.05	1.10	1.05	1.05
304	L2		L3	L4
	i ≤ 22.7	i > 22.7		
n ₁ = 1800 rpm	0.96	0.98	0.91	0.91
n ₁ = 1200 rpm	1.05	1.03	1.04	1.04
n ₁ = 1000 rpm	1.10	1.06	1.05	1.05
305	L2		L3	L4
	i ≤ 26.4	i > 26.4		
n ₁ = 1800 rpm	0.90	0.93	0.90	0.90
n ₁ = 1200 rpm	1.03	1.02	1.02	1.02
n ₁ = 1000 rpm	1.06	1.04	1.04	1.04
306	L2		L3	L4
	i ≤ 26.4	i > 26.4		
n ₁ = 1800 rpm	0.85	0.95	0.95	0.95
n ₁ = 1200 rpm	1.03	1.02	1.02	1.02
n ₁ = 1000 rpm	1.12	1.04	1.04	1.04
307	L2		L3	L4
	i ≤ 28.0	i > 28.0		
n ₁ = 1800 rpm	0.87	0.92	0.97	0.97
n ₁ = 1200 rpm	1.10	1.03	1.02	1.02
n ₁ = 1000 rpm	1.18	1.06	1.05	1.05
309	L2		L3	L4
	i ≤ 25.4	i > 25.4		
n ₁ = 1800 rpm	*	0.88	0.95	0.95
n ₁ = 1200 rpm	1.10	1.06	1.02	1.02
n ₁ = 1000 rpm	1.22	1.10	1.05	1.05
310M	L2		L3	L4
	i ≤ 25.4	i > 25.4		
n ₁ = 1800 rpm	*	*	0.95	0.95
n ₁ = 1200 rpm	1.20	1.15	1.02	1.02
n ₁ = 1000 rpm	1.50	1.20	1.05	1.05
311M	L2		L3	L4
	i ≤ 21.5	i > 21.5		
n ₁ = 1800 rpm	*	*	0.90	0.90
n ₁ = 1200 rpm	1.10	1.15	1.05	1.05
n ₁ = 1000 rpm	1.50	1.26	1.10	1.10
313M	L2		L3	L4
	i ≥ 21.8			
n ₁ = 1800 rpm	*		0.60	0.60
n ₁ = 1200 rpm	1.20		1.05	1.05
n ₁ = 1000 rpm	1.50		1.10	1.10
314M	L2		L3	L4
	i ≥ 22.3			
n ₁ = 1800 rpm	*		*	*
n ₁ = 1200 rpm	1.20		1.05	1.05
n ₁ = 1000 rpm	1.45		1.10	1.10

(L)	f _{speed}			
	L2		L3	L4
315M	L2		L3	L4
	i ≤ 22.3	i > 22.3		
n ₁ = 1800 rpm	*	*	*	0.90
n ₁ = 1200 rpm	1.50	1.16	1.15	1.07
n ₁ = 1000 rpm	1.70	1.30	1.25	1.10
316M	L2		L3	L4
	i ≤ 21.8	i > 21.8	i ≤ 114	i > 114
n ₁ = 1800 rpm	*	*	*	*
n ₁ = 1200 rpm	*	1.15	1.2	1.15
n ₁ = 1000 rpm	*	1.45	1.30	1.20
317M	L2		L3	L4
			i ≤ 69.3	i > 69.3
n ₁ = 1800 rpm	*		*	*
n ₁ = 1200 rpm	*		1.2	1.05
n ₁ = 1000 rpm	1.00		1.25	1.20
318M	L2		L3	L4
			i ≤ 98.2	i > 98.2
n ₁ = 1800 rpm	*		*	*
n ₁ = 1200 rpm	*		1.30	1.15
n ₁ = 1000 rpm	*		1.50	1.20
319	L2		L3	L4
			i ≤ 126	i > 126
n ₁ = 1800 rpm	*		*	*
n ₁ = 1200 rpm	*		1.25	1.15
n ₁ = 1000 rpm	*		1.30	1.20
321	—		L3	L4
			i ≤ 126	i > 126
n ₁ = 1800 rpm	—		*	*
n ₁ = 1200 rpm	—		*	*
n ₁ = 1000 rpm	—		1.00	1.00
323	—		L3	L4
n ₁ = 1800 rpm	—		*	*
n ₁ = 1200 rpm	—		*	*
n ₁ = 1000 rpm	—		*	*
325	—		L3	L4
n ₁ = 1800 rpm	—		*	*
n ₁ = 1200 rpm	—		*	*
n ₁ = 1000 rpm	—		*	*

* BONFIGLIOLI TECHNICAL SERVICE



(A 12)

(R)	f speed		
300	R2	R3	R4
n ₁ = 1800 rpm	0.95	0.97	0.97
n ₁ = 1200 rpm	1.05	1.04	1.04
n ₁ = 1000 rpm	1.15	1.05	1.05
301	R2	R3	R4
n ₁ = 1800 rpm	0.88	0.90	0.90
n ₁ = 1200 rpm	1.05	1.03	1.03
n ₁ = 1000 rpm	1.15	1.05	1.05
303	R2	R3	R4
n ₁ = 1800 rpm	0.90	0.93	0.93
n ₁ = 1200 rpm	1.05	1.03	1.03
n ₁ = 1000 rpm	1.10	1.05	1.05
304	R2	R3	R4
n ₁ = 1800 rpm	0.90	0.93	0.93
n ₁ = 1200 rpm	1.05	1.03	1.03
n ₁ = 1000 rpm	1.08	1.05	1.05
305	R2	R3	R4
n ₁ = 1800 rpm	0.90	0.93	0.93
n ₁ = 1200 rpm	1.05	1.03	1.03
n ₁ = 1000 rpm	1.12	1.05	1.05
306	R2	R3	R4
n ₁ = 1800 rpm	0.85	0.88	0.88
n ₁ = 1200 rpm	1.05	1.03	1.03
n ₁ = 1000 rpm	1.08	1.05	1.05
307	—	R3	R4
n ₁ = 1800 rpm	—	0.90	0.94
n ₁ = 1200 rpm	—	1.03	1.02
n ₁ = 1000 rpm	—	1.06	1.05
309	—	R3	R4
n ₁ = 1800 rpm	—	0.80	0.85
n ₁ = 1200 rpm	—	1.03	1.02
n ₁ = 1000 rpm	—	1.06	1.05
310M	—	R3	R4
n ₁ = 1800 rpm	—	0.90	0.93
n ₁ = 1200 rpm	—	1.03	1.02
n ₁ = 1000 rpm	—	1.08	1.04
311M	—	R3	R4
n ₁ = 1800 rpm	—	0.80	0.85
n ₁ = 1200 rpm	—	1.07	1.05
n ₁ = 1000 rpm	—	1.12	1.10

(R)	f speed		
313M	—	R3	R4
n ₁ = 1800 rpm	—	0.80	0.85
n ₁ = 1200 rpm	—	1.08	1.05
n ₁ = 1000 rpm	—	1.12	1.08
314M	—	R3	R4
n ₁ = 1800 rpm	—	*	0.90
n ₁ = 1200 rpm	—	1.15	1.10
n ₁ = 1000 rpm	—	1.25	1.18
315M	—	R3	R4
n ₁ = 1800 rpm	—	*	0.80
n ₁ = 1200 rpm	—	1.10	1.08
n ₁ = 1000 rpm	—	1.25	1.15
316M	—	R3	R4
n ₁ = 1800 rpm	—	*	0.80
n ₁ = 1200 rpm	—	1.15	1.10
n ₁ = 1000 rpm	—	1.25	1.15
317M	—	R3	R4
n ₁ = 1800 rpm	—	*	0.75
n ₁ = 1200 rpm	—	1.20	1.10
n ₁ = 1000 rpm	—	1.25	1.15
318M	—	—	R4
n ₁ = 1800 rpm	—	—	*
n ₁ = 1200 rpm	—	—	1.08
n ₁ = 1000 rpm	—	—	1.15
319	—	—	R4
n ₁ = 1800 rpm	—	—	*
n ₁ = 1200 rpm	—	—	1.05
n ₁ = 1000 rpm	—	—	1.15
321	—	—	R4
n ₁ = 1800 rpm	—	—	*
n ₁ = 1200 rpm	—	—	1.05
n ₁ = 1000 rpm	—	—	1.15

*  BONFIGLIOLI TECHNICAL SERVICE



(A 13)

(L)	f _{pos}			
	L2		L3	L4
300	i ≤ 20.1	i > 20.1		
	0.65	0.85	0.88	0.88
301	i ≤ 20.1	i > 20.1		
	0.70	0.90	0.88	0.88
303	L2		L3	L4
	0.83		0.90	0.90
304	i ≤ 22.7	i > 22.7		
	0.80	0.85	0.85	0.85
305	i ≤ 26.4	i > 26.4		
	0.80	0.85	0.85	0.85
306	i ≤ 26.4	i > 26.4		
	0.80	0.85	0.85	0.85
307	i ≤ 28.0	i > 28.0		
	0.80	0.85	0.85	0.85
309	i ≤ 25.4	i > 25.4		
	0.40	0.75	0.85	0.85
310M	i ≤ 25.4	i > 25.4		
	*	0.70	0.85	0.85
311M	i ≤ 21.5	i > 21.5		
	*	0.40	0.80	
313M	L2		L3	L4
	0.40		0.75	0.75
314M	L2		L3	L4
	*		0.80	0.80

(L)	f _{pos}			
	L2	L3		L4
315M		i ≤ 108	i > 108	
	*	0.50	0.75	0.75
316M		i ≤ 114	i > 114	
	*	*	0.65	0.70
317M		i ≤ 69.3	i > 69.3	
	*	0.50	0.55	0.75
318M		i ≤ 98.2	i > 98.2	
	0.70	*	*	0.70
319	i ≥ 26	i ≤ 126	i > 126	
	0.90	*	0.70	0.75
321	—	L3		L4
	—	i ≤ 98.2	i > 98.2	i ≤ 308 i > 308
323	—	L3		L4
	—	i ≤ 120	i > 120	i ≤ 500 i > 500
325	—	L3		L4
	—	i ≤ 120	i > 120	i ≤ 500 i > 500

* BONFIGLIOLI TECHNICAL SERVICE

(A 14)

(R)	f _{pos}		
	R2	R3	R4
300			
	0.87	0.90	0.90
301			
	0.86	0.90	0.90
303			
	0.90	0.92	0.92
304			
	0.88	0.92	0.92
305			
	0.86	0.90	0.90
306			
	0.88	0.92	0.92
307	—	R3	R4
	—	0.85	0.92
309	—	R3	R4
	—	0.84	0.92
310M	—	R3	R4
	—	0.90	0.93
311M	—	R3	R4
	—	0.65	0.70

(R)	f _{pos}		
		R3	R4
313M	—	R3	R4
	—	0.75	0.80
314M	—	R3	R4
	—	*	0.70
315M	—	R3	R4
	—	*	0.75
316M	—	R3	R4
	—	*	0.90
317M	—	R3	R4
	—	*	0.90
318M	—	—	R4
	—	—	0.70
319	—	—	R4
	—	—	0.70
321	—	—	R4
	—	—	0.70

* BONFIGLIOLI TECHNICAL SERVICE



(A 15)

(L)	$f_{air} < 1.4 \text{ m/s}$		
	L2	L3	L4
300	L2	L3	L4
	0.50	0.75	0.75
301	L2	L3	L4
	0.60	0.70	0.70
303	L2	L3	L4
	0.55	0.60	0.60
304	L2	L3	L4
	0.66	0.70	0.70
305	L2	L3	L4
	0.60	0.63	0.63
306	L2	L3	L4
	0.55	0.65	0.65
307	L2	L3	L4
	0.50	0.60	0.60
309	L2	L3	L4
	*	0.6	0.6
310M	L2	L3	L4
	0.50	0.65	0.65
311M	L2	L3	L4
	0.50	0.60	0.60
313M	L2	L3	L4
	*	0.50	0.50
314M	L2	L3	L4
	*	0.60	0.60
315M	L2	L3	L4
	*	0.55	0.55
316M	L2	L3	L4
	*	0.55	0.55

(L)	$f_{air} < 1.4 \text{ m/s}$			
	L2	L3		L4
317M	L2	L3		L4
		$i \leq 69.3$	$i > 69.3$	
	*	0.50	0.55	0.60
318M	L2	L3		L4
		$i \leq 98.2$	$i > 98.2$	
	0.55	*	0.45	0.60
319	L2	L3		L4
		$i \leq 126$	$i > 126$	
	0.60	0.45	0.60	0.60
321	—	L3		L4
		$i \leq 98.2$	$i > 98.2$	$i \leq 308$ $i > 308$
	—	*	0.60	0.60 0.70
323	—	L3		L4
		0.70		0.60
325	—	L3		L4
		0.70		0.60

* BONFIGLIOLI TECHNICAL SERVICE

(A 16)

(R)	$f_{air} < 1.4 \text{ m/s}$		
	R2	R3	R4
300	R2	R3	R4
	0.70	0.75	0.75
301	R2	R3	R4
	0.60	0.65	0.65
303	R2	R3	R4
	0.65	0.65	0.65
304	R2	R3	R4
	0.55	0.60	0.60
305	R2	R3	R4
	0.60	0.65	0.65
306	R2	R3	R4
	0.60	0.65	0.65
307	—	R3	R4
	—	0.62	0.66
309	—	R3	R4
	—	0.60	0.65
310M	—	R3	R4
	—	0.60	0.65
311M	—	R3	R4
	—	0.55	0.60

(R)	$f_{air} < 1.4 \text{ m/s}$		
	R3	R4	
313M	—	R3	R4
	—	0.55	0.60
314M	—	R3	R4
	—	0.55	0.65
315M	—	R3	R4
	—	*	0.60
316M	—	R3	R4
	—	*	0.60
317M	—	R3	R4
	—	*	0.65
318M	—	—	R4
	—	—	*
319	—	—	R4
	—	—	*
321	—	—	R4
	—	—	*

* BONFIGLIOLI TECHNICAL SERVICE



(A 17)

(L)	f _{input V}			
309	L2		L3	L4
	0.92		0.95	0.95
310M	L2		L3	L4
	0.60		0.90	0.90
311M	L2		L3	L4
	i ≤ 21.5	i > 21.5		
	*	0.76	0.95	0.95
313M	L2		L3	L4
	i ≥ 21.5			
	0.40		0.90	0.90
314M	L2		L3	L4
	i ≥ 22.3			
	0.45		0.85	0.85
315M	L2		L3	L4
	i ≤ 22.3	i > 22.3		
	0.50	0.54	0.85	0.85

* BONFIGLIOLI TECHNICAL SERVICE

(L)	f _{input V}			
316M	L2	L3		L4
	*	i ≤ 114	i > 114	0.45
		0.6	0.45	0.45
317M	L2	L3		L4
		i ≤ 69.3	i > 69.3	
	1.00	0.65	0.70	0.75
318M	L2	L3		L4
		i ≤ 98.2	i > 98.2	
	1.00	*	0.80	0.80
319	L2	L3		L4
		i ≤ 126	i > 126	
	1.00	0.85	0.90	0.90
321	—	L3		L4
	—	1.00		0.85
323	—	L3		L4
	—	1.00		1.00
325	—	L3		L4
	—	1.00		1.00

(A 18)

(R)	f _{input V}	
309	R3	R4
	0.94	0.97
310M	R3	R4
	0.90	0.95
311M	R3	R4
	0.90	0.95
313M	R3	R4
	0.90	0.93
314M	R3	R4
	0.70	0.75

* BONFIGLIOLI TECHNICAL SERVICE

(R)	f _{input V}	
315M	R3	R4
	0.60	0.70
316M	R3	R4
	0.70	0.80
317M	R3	R4
	0.75	0.85
318M	—	R4
	—	0.90
319	—	R4
	—	0.90
321	—	R4
	—	0.90

(A 19)

cycling duration factor [%] based 60 min running (running on load [min]/60*100)					
	100	80	60	40	20
f_{id}	1.0	1.1	1.4	1.7	2

(A 20)

	L1 only for	L2	L3-L4	R2	R3-R4
f_{nb}	0.8	0.9	1	0.8	0.9



b) Auxiliary thermal devices

If $P_T < P_{r1}$, gearboxes are available with auxiliary thermal devices (FV, PFAN, CRX).

Supplementary cooling systems are made up of an air-oil heat exchanger, a motor pump, a filter for warm oil and an electric system that incorporates an overload cutout for electric motors. A special feature of these cooling systems is their low noise.

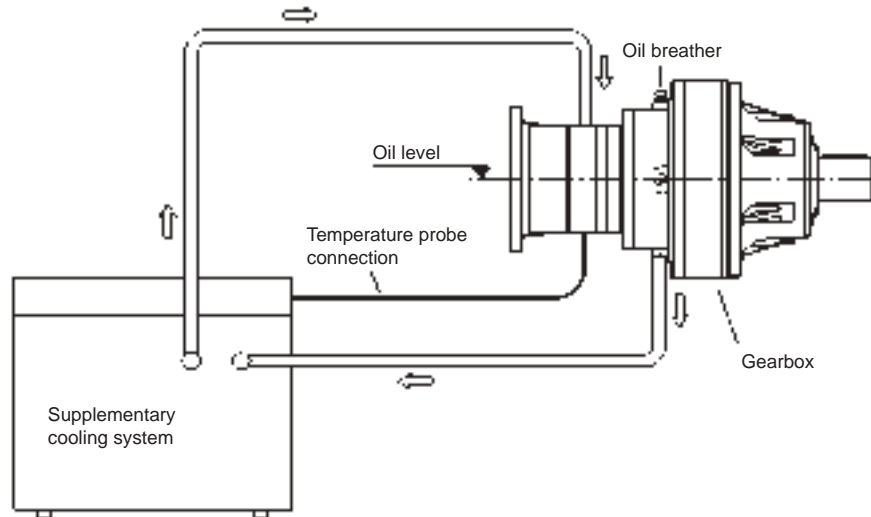

Technical data

(A 21)		CR1	CR2	CR3
Power absorption	[kW]	0.55	0.75	1.1
Pumpflow	[l/min]	13	22	34
Air flow	[m ³ /h]	850	1500	2000
Noise level at 1 mt.	[dB(A)]	68	70	75
Weight	[kg]	24	36	58

Calculate excess power P_s using this formula:

$$P_s = (1 - \eta_d) \times (P_{r1} - P_T) \quad (27)$$

Select thermal device according the following chart.

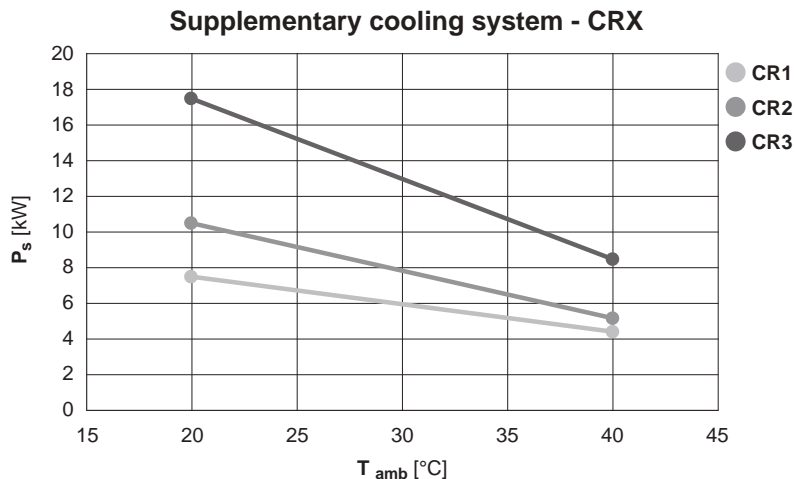



Electric motor connection with integrated fan - PF

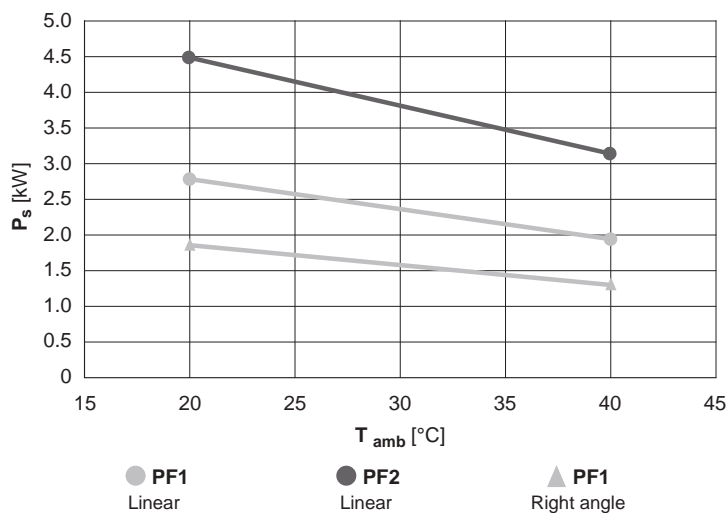

	L1	L2	L3	L4	R2	R3	R4
300	PF1	PF1	PF1	PF1	PF1	PF1	PF1
301	PF1	PF1	PF1	PF1	PF1	PF1	PF1
303	PF1	PF1	PF1	PF1	PF1	PF1	PF1
304	PF1	PF1	PF1	PF1	PF1	PF1	PF1
305	PF1	PF1	PF1	PF1	PF1	PF1	PF1
306	PF1	PF1	PF1	PF1	PF1	PF1	PF1
307	PF2	PF1	PF1	PF1	PF1	PF1	PF1
309	PF2	PF1	PF1	PF1	PF1	PF1	PF1
310M	PF2	PF1	PF1	PF1	PF1	PF1	PF1
311M	PF2	PF2	PF1	PF1	PF1	PF1	PF1
313M	—	PF2	PF1	PF1	PF1	PF1	PF1
314M	—	PF2	PF1	PF1	—	PF1	PF1
315M	—	PF2	PF2	PF1	—	PF1	PF1
316M	—	PF2	PF2	PF1	—	PF1	PF1
317M	—	—	PF2	PF1	—	PF1	PF1
318M	—	—	PF2	PF2	—	—	PF1
319	—	—	PF2	PF2	—	—	PF1
321	—	—	—	PF2	—	—	PF1
323	—	—	—	PF2	—	—	—
325	—	—	—	PF2	—	—	—

Solid input shaft with fan - FV

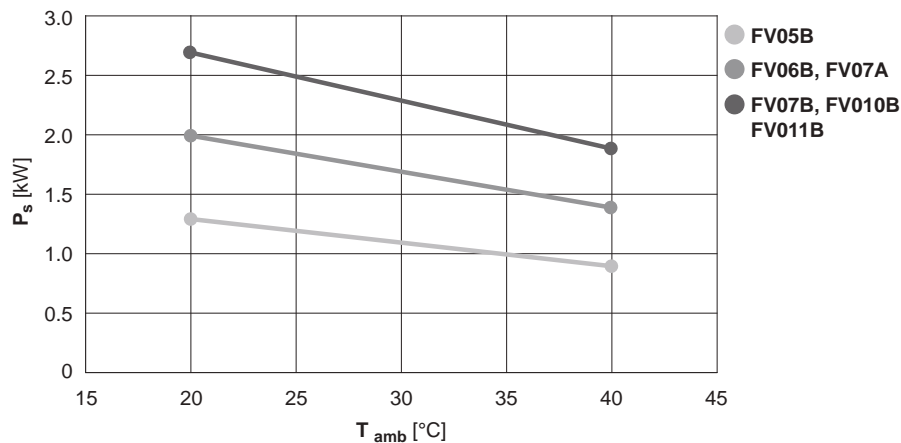

Check that the cooling system you have selected will fit the gearbox (see table A22).
If this is not the case, contact our sales organization.

(A 22)

Gearbox	L1	L2	L3	L4	R2	R3	R4
306	CR1	CR1	—	—	—	—	—
307	CR1	CR1	—	—	CR1	—	—
309	CR1	CR1	CR1	—	CR1	—	—
310M	CR2	CR1	CR1	—	—	CR1	—
311M	CR2	CR1	CR1	—	CR1	CR1	—
313M	CR2	CR1	CR1	—	CR1	CR1	—
314M	CR3	CR2	CR1	—	—	CR1	—
315M	CR3	CR2	CR1	—	—	CR1	—
316M	CR3	CR2	CR1	—	—	CR1	—
317M	CR3	CR2	CR2	CR1	—	—	—
318M	CR3	CR2	CR2	CR1	—	—	—
319	CR3	CR2	CR2	CR1	—	—	—
321	CR3	CR2	CR2	CR2	—	—	—



Dimensions

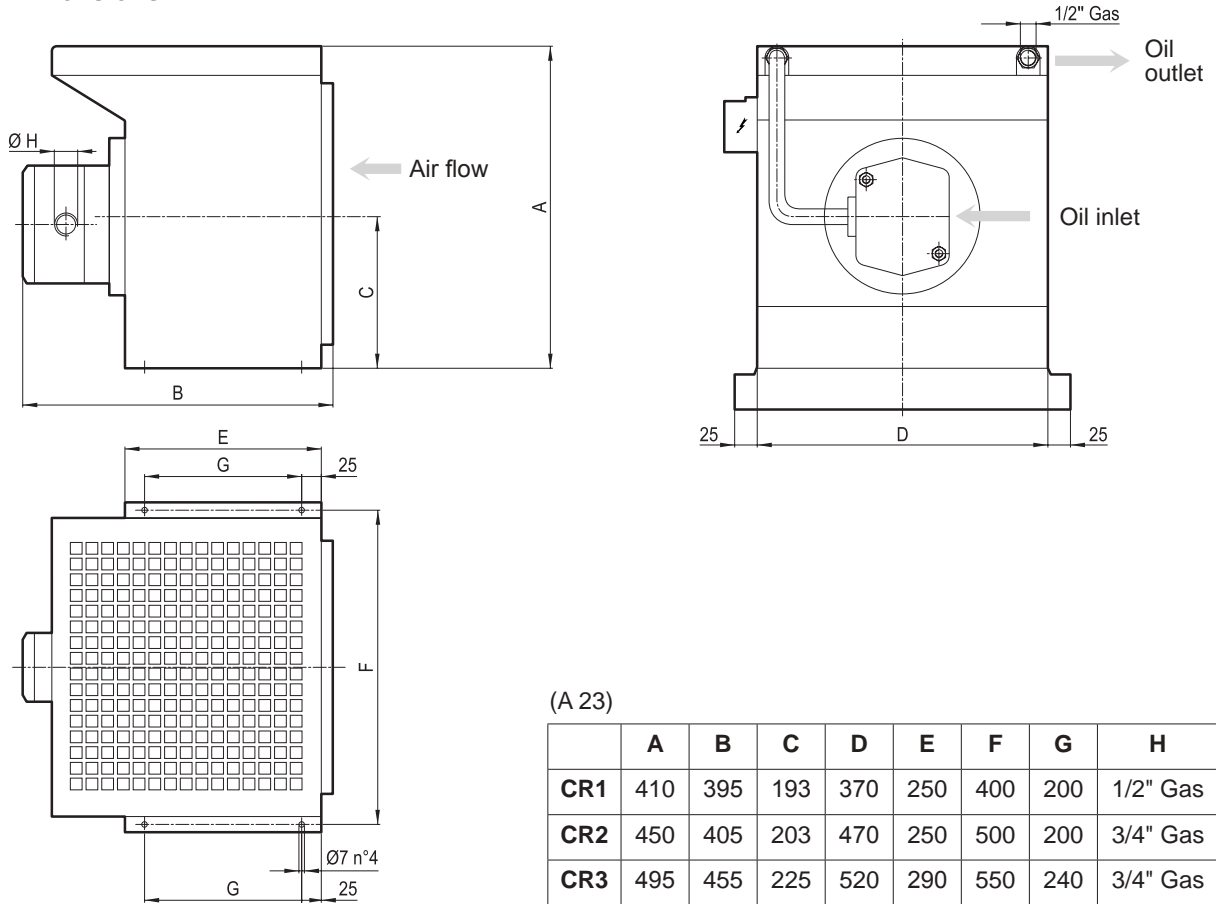

c) Maximum torque

Make sure that neither the momentary peak torque nor the starting torque under load ever exceed the M_{2max} value that the gearbox is rated for (see figure A2).

d) Radial loads

Examine the application and establish:

- overhung load applying to input and/or output shaft through the following formula:

$$R_{c1-2} = \frac{2000 \times M_{r1-2} \times K_r}{d} \quad (28)$$

R_{c1-2} = overhung load [N]

1 = for input shaft

2 = for output shaft

M_{r1-2} = Torque at the shaft [Nm]

d = P.C.D [mm] of transmission element (sprocket, gear, pulley, etc.)

$K_r = 1$ chain transmission

$K_r = 1.25$ gear transmission

$K_r = 1.5-2.5$ V-belt transmission

- Define the trust load position X onto shaft. Check this value with the chart indicating the load R_{x1-2} bearable by the gearbox. Check that the following is satisfied:

$$R_{c1-2} \leq R_{x1-2} \times fh_{1-2} \quad (29)$$



where fh_{1-2} are the radial and thrust load corrective factor depending on the required life factor Fh_1 and Fh_2 (refers to radial and thrust loads in the "Dimensions" chapter).

e) Thrust loads

Check the thrust load, when exerted onto the output shaft, as specified for the radial load.
The following should be satisfied:

$$\pm A_{c2} \leq \pm A_{n2} \times fh_2 \quad (30)$$

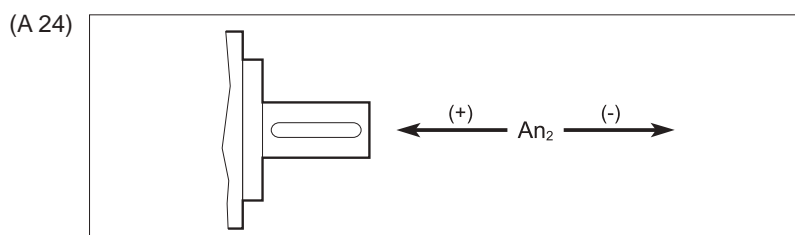

where fh_2 are the radial and thrust load corrective factor depending on the required life factor Fh_2 (refers to radial and thrust loads in the "Dimensions" chapter).

When a thrust load is combined with an axial load contact our Sales Dept. for a proper checking procedure.

f) VK output

Determine:

- Radial load R_{c2}
- Thrust load A_{c2}
- Offset x of load R_{c2}

Look up the diagram relevant to the gearbox under study and identify permitted radial load R_{x2} corresponding to distance X and the ratio $An2/Rn2$ nearest to value $Ac2/Rc2$.

Make sure the following equation is verified:

$$R_{x2} \geq R_{c2} \quad (31)$$

Values in the diagram refer to:

- $n_2 = 10$ rpm
- 10000 hrs theoretical lifetime

For different output speed n_2 , or lifetime expectancy, consider:

- a speed factor f_{n2} as per table (A25):

(A 25)

n_2	1	2.5	5	10	15	25	50	100
f_{n2}	2.0	1.51	1.23	1.00	0.88	0.76	0.62	0.50

- a lifetime factor f_L according to table (A26).

(A 26)

Lifetime	2500 h	5000 h	10000 h	15000 h	25000 h	50000 h	100000 h	100
f_L	0.66	0.81	1.00	1.13	1.32	1.62	2.00	0.50



This condition must be verified:

$$R_{x2} \times f_{n2} \geq R_{c2} \times f_L \quad (32)$$

g) FP output (FDK and FZP when and if available)

On shaft-mounted installations, gearmotors produce a reaction force due to fixing position and motor weight and/or external loads from other connection elements.

These forces combination is added to normal load condition and will influence :

- bearings life
- output shaft resistance
- flange tightening condition

In the event that there is an additional load (like a large size electric motor) and /or a single stage gearbox (with particular attention to sizes from 300 to 307), it's recommended to contact our Technical Service.

For the specific reaction loads due to fixing position, in the dimensional section for each size are reported the minimum length for torque reaction arms (single or double) that can reach the rated performances.

14.6 HOW TO SELECT THE MOTOR

14.6.1 Electric motor (see section M in this catalogue)

a) n_2 and dynamic efficiency η_d are known, calculate input power based on torque M_{r2} as follows

$$P_{r1} = \frac{M_{r2} \times n_2}{9550 \times \eta_d} \quad [\text{kW}] \quad (33)$$

Table (A3) reports the values of efficiency η_d related to the different reduction stages of the gearboxes of series 300M.

b) Look up the motor selection charts and select a size with such rated power to satisfy this condition:

$$P_{r1} \leq P_n \quad (34)$$

4-pole motors and over should be preferred.

Unless otherwise specified, power P_n of motors indicated in the catalogue refers to continuous duty S1. For motors used in conditions other than S1, the type of duty required by reference to CEI 2-3/IEC 34-1 Standards must be mentioned.

For duties from S2 to S8 in particular and for motor frame 132 or smaller, extra power can be obtained with respect to continuous duty power, consequently the following condition must be satisfied:

$$\frac{P_{r1}}{f_m} \leq P_n \quad (35)$$





The increased power factor f_m can be obtained from table (A5).



For duties other than S1 with considerable number of starts per hour, factor Z must be considered (it is ascertained by using the information in the motors chapter). Factor Z defines the maximum number of starts for the application under consideration.

14.6.2 Hydraulic motor (see section H in this catalogue)

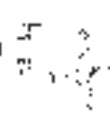
Determine hydraulic motor type according to the application, choosing from the options given in guidance table (A27).

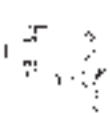
Duty	Light		Medium		Heavy	
	<175		175 - 200		200 - 450	
Pressure p [bar]	<175		175 - 200		200 - 450	
Motor design	orbital 	gear motor 	radial piston 	axial piston 	cam motor 	axial piston 
Speed	medium ≤ 700	high ≤ 3000	medium ≤ 500	high ≤ 4000	low ≤ 200	medium ≤ 4000
η _{mh}	0.80	0.85	0.95	0.93	0.93	0.93
η _v	0.90	0.87	0.95	0.95	0.95	0.95

Based on the specifications of gearbox input:

- input torque M_{r1} [Nm]
- input speed n_1 [min^{-1}]

and on allowed pressure p [bar] for the hydraulic circuit, calculate the displacement of the hydraulic motor by formula:

$$V_c = \frac{20 \times \pi \times M_{r1}}{p \times \eta_{mh}} \text{ [cm}^3\text{]} \quad (36)$$

Where η_{mh} is the hydraulic mechanical efficiency of the motor (tab. A27).

Select a motor size with displacement V that satisfies the following condition:

$$V_c \leq V \quad (37)$$

Calculate the flow required for the hydraulic motor

$$Q_1 = \frac{V \times n_1}{\eta_v \times 1000} \text{ [l/min]} \quad (38)$$

where η_v is volumetric efficiency.

For hydraulic orbital motors by BONFIGLIOLI TRASMITAL, please see section H in this catalogue. For other types of hydraulic motors, see the relevant technical literature.



15 INSTALLATION

Observing a few rules for correct installation is essential to the reliable and proper operation of the gearbox.

The rules set out here are intended as a preliminary guide to selecting gearbox.

For effective and proper installation, follow the instructions given in the Installation, use and maintenance manual available from our Sales network.

Following is a brief outline of installation rules:

a) Fastening:

- Place the gearbox on a surface providing adequate rigidity. Mating surfaces should be machined and flat.
- This applies especially to flange-mounted gearboxes with splined hollow output shafts (refer to the Installation, Operation and Maintenance Manual available on www.bonfiglioli.com).
- In applications that involve high radial loads at the output end, flange mounting is recommended for some gearboxes as this mounting pattern benefits from the double pilot diameters provided on these gearboxes (refer to the Installation, Operation and Maintenance Manual available on www.bonfiglioli.com).
- Make sure the gearbox is suitable for the required mounting position.
- Use bolts specified in Use and Maintenance Manual (available on www.bonfiglioli.com) and tighten the bolts to the rated values specified in the relevant charts.

b) Connections

- When fitting transmission elements onto the gearbox do not tap them with hammers or similar tools. To slide these parts in, use the service screws and tappings provided at the shaft ends. Be sure to clean off any grease or rust preventative from the shafts before fitting any parts.
 - Direction of rotation
- Before wiring the motor please note the input/output shaft arrangement, as described in the diagram here after:

(A 28)

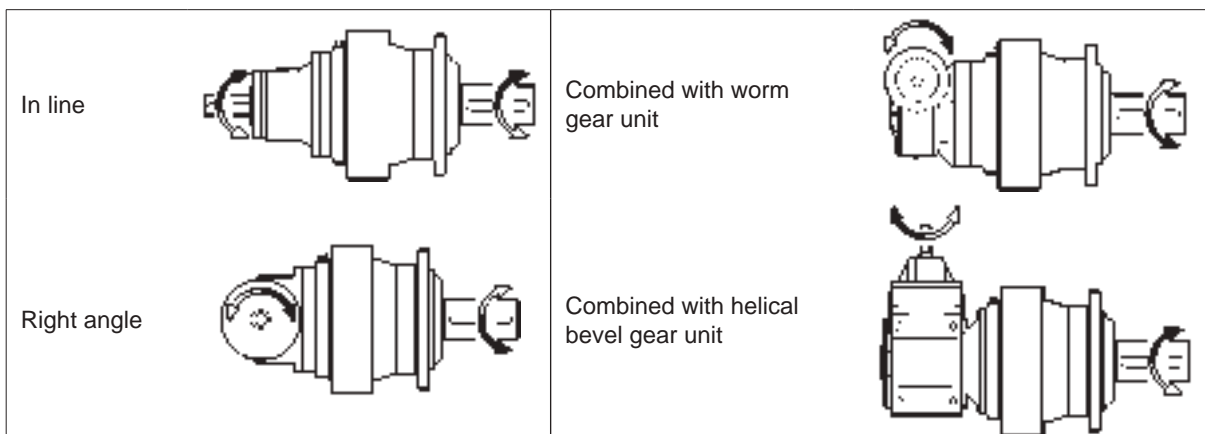

RA/RO: For the monodirectional applications or for the applications requiring a sense of rotation prevailing on that opposite to it, the selection of "RA/RO" option ensures the declared performance. For applications not requiring a prevailing sense of rotation with respect to each other, the performances are guaranteed regardless of the selected "RA/RO" option.

c) Paint coating

- Use paint compatible with the primer applied to the gearbox, see "Supply conditions". Prior to painting, tape the seal rings installed on the shafts. Contact with the solvent may damage the seals with subsequent oil leakage.



d) Lubrication

– Prior to commissioning, fill the gearbox with the recommended type and quantity of oil (refer to the Installation, Operation and Maintenance Manual available on www.bonfiglioli.com).

The level is to be checked through the appropriate plug, or sight glass, each gearbox is provided with, and located according to the mounting position originally specified.

NOTE: Combined gearboxes feature separate lubrication for planetary stages and for worm gears (series 3/V_M) or bevel helical units (series 3/A).

The operations described above are not to be performed with life-lubed gearboxes, that are factory filled with synthetic oil.

16 LUBRICATION

Refer to the User's Manual available at www.bonfiglioli.com for indications about checking the oil level and its replacement.

Do not mix mineral oils with synthetic oils and/or different brands.

However, oil level should be checked at regular intervals and topped up as required.

Check monthly if unit operates under intermittent duty, more frequently if duty is continuous.

16.1 Selection of the optimal oil viscosity (data relating to Shell Oils)

		Operating ambient temperature [C°]																		
		-40	-35	-30	-25	-20	-15	-10	-5	0	+5	+10	+15	+20	+25	+30	+35	+40	+45	+50
		suitability seals check			standard seals provided in the catalog															
Splash lubrication	Mineral oil	150 VG								*										
		220 VG	⊘							*										
		320 VG		Ⓢ						*										
460 VG				Ⓢ					*											
Synthetic oil (PAG)	150 VG		*																Ⓢ	
	220 VG	⊘		Ⓢ																
	320 VG		Ⓢ	*																
Synthetic oil (PAO)	150 VG			*															Ⓢ	
	220 VG	⊘			Ⓢ															
	320 VG		Ⓢ	*					*											
Mineral oil	150 VG									*										
	220 VG	⊘							Ⓢ											
	320 VG									*										
Synthetic oil (PAG)	150 VG									*	*								Ⓢ	
	220 VG	⊘								*	*									
	320 VG		Ⓢ							*	*									
Synthetic oil (PAO)	150 VG									*	*								Ⓢ	
	220 VG	⊘								*	*									
	320 VG		Ⓢ							*	*									

Recommended operating limits
 Allowed operating limits
 Ⓢ Forbidden operating limits

* = It is recommended to ramp-up and to provide for greater absorption of the motor.

If needed and in the event of impulse loads, contact Bonfiglioli Technical Service. Ⓢ



16.2 Lubrication for 300M series gearboxes

All gearboxes are oil-bath lubricated. For applications calling for gearboxes with a vertically positioned axis, in which oil coverage during operation would not be sufficient to ensure correct lubrication of upper bearings, suitable life lubrication systems are used.

Prior to starting-up, fill the gearbox with the appropriate quantity of oil.

Gearboxes are generally provided with oil fill, level and drain plugs. As such, the mounting position needs always to be specified when ordering the gearbox.

For the reference charts of oil plugs placement and quantity of lubricant, refer to the Installation, Operation and Maintenance Manual (available on www.bonfiglioli.com).

– Note: For applications with non-routine operating conditions, consult factory with complete information.

– Unless otherwise specified, gear units are supplied unlubricated. Primary gear units belonging to 3/V_M and 3/A combinations instead may be supplied factory filled with long-life synthetic lubricant, depending on their frame size, as indicated in the Use and Maintenance Manual (available at www.bonfiglioli.com).

– The oil capacities listed for the various types of unit are indicative only. Fill the gearbox up to the level plug, located as per the mounting position specified when ordering to ensure the gearbox is properly filled.

– Should transmitted power exceed the thermal capacity of the unit a supplementary cooling unit must be provided (see: Auxiliary thermal devices).

NOTE: Combined gearboxes and gearmotors feature separate lubrication for planetary stages and for worm gearboxes (3/V_M) or helical bevel units (3/A).

16.3 Brakes lubrication

The hydraulically operated multidisc brakes are lubricated by the same oil as the gearbox.

17 STORAGE

Observe the following instructions to ensure correct storage of delivered products:

a) Do not store outdoors, in areas exposed to weather or with excessive humidity.

b) Always place boards, wood, or other material between the products and the floor. The gearbox should not have direct contact with the floor.

c) For storage periods of over 60 days, all machined surfaces such as flanges, shafts and couplings must be protected with a suitable anti-oxidation product.

d) In the cases of long-term storage defined in the order phase with the optional choice of SLM or SLP (see specific chapter for cases and times), the appropriate technical requirements are given in the User Manual available on www.bonfiglioli.com. To guarantee times, conditions and extensions, contact the Bonfiglioli Assistance Center available on the company website.



18 SUPPLY CONDITIONS

Gearboxes are supplied as follows:



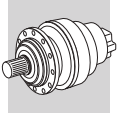



- a) arranged for installation in the mounting position specified in the purchase order;
- b) Unlubricated. Inner parts are protected by a film of the oil used for testing purpose;
- c) when no specific protection class is requested, the surfaces of gearboxes are protected to at least corrosivity class C2 (UNI EN ISO 12944-2), realized with a grey antioxidant water-based primer Ral 7042. Mating surface are not coated .
- d) tested to factory specifications;
- e) suitably packed;
- f) complete with mounting hardware for IEC electric or hydraulic motors;
- g) gearboxes lubricated “for life” are factory filled with oil.



19 300M GEARBOX DESIGNATION

3 11M L 2 16.7 HZ

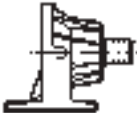
OUTPUT VERSION

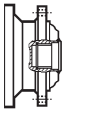
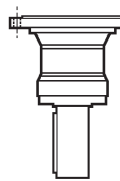
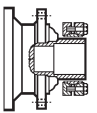
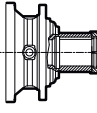
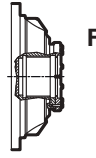
	MZ: Splined male shaft		MC: Solid keyed shaft
	HZ: Heavy duty splined male shaft		HC: Heavy duty solid keyed shaft
	PZ: Foot base with splined shaft		PC: Foot base with solid keyed shaft
	FZ / FZB: Hollow splined shaft		VK: Reinforced output with heavy duty keyed shaft for stirrers and mixer
	FP: Hollow shaft for shrink disc		
	FDK: Hollow shaft with double keyway		FZP: Hollow splined shaft with axial blockage device (recommended for shaft mounted installation)

Reduction ratio
 Fill in the value of the transm. ratio (including point and decimals) reported in the selection charts
 Es. : 1/5.33 = 5.33 1/44.6 = 44.6 1/131 = 131

No. OF REDUCTIONS
1, 2, 3, 4

DESIGN
L = Linear

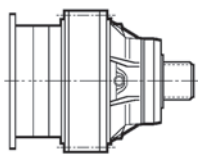

R = Right angle

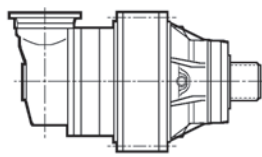

GEARBOX SIZE

00 = 300	252	05 = 305	296	10M = 310M	302	15M = 315M	392	19 = 319	434
01 = 301	262	06 = 306	308	11M = 311M	314	16M = 316M	404	21 = 321	444
03 = 303	272	07 = 307	320	13M = 313M	326	17M = 317M	414	23 = 323	454
04 = 304	284	09 = 309	332	14M = 314M	338	18M = 318M	424	25 = 325	458

SERIES

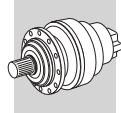

6A S5EC A A WOA

OPTIONS
GASKET
 STANDARD = NBR
PV = Fluoro elastomer
 (hydraulic inputs
 BONFIGLIOLI
 TECHNICAL SERVICE)

ONLY FOR RIGHT ANGLE DESIGN
 preferential input direction of rotation

RA = left
RO = right



32

SURFACE PROTECTION
C2 (default), **C3**, **C4**

43

PAINTING
RAL7042 (default), **RAL5010**,
RAL9005, **RAL9006**, **RAL9010**

43

CERTIFICATES
AC, **CC**

44

SUPPLEMENTARY COOLING SYSTEM
CR1, **CR2**, **CR3**

26

OUTPUT FITTINGS



P... = Pinions



B0A = Splined bar



M0A = Sleeve coupling



G0A = Shrink disc



W0A = Flange

MOTOR FLANGE ORIENTATION

467

MOUNTING POSITION

44

INPUT



Without motor adaptor

V9AA	V9AC	V9AE	V9AG	V9AL
V9AB	V9AD	V9AF	V9AH	

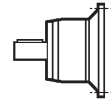

Input keyed shaft

	V01A	V01B	V05B	V06B	V07A	V07B	V10B	V11B	V15B
diam.	Ø24	Ø38	Ø48	Ø60	Ø60	Ø80	Ø80	Ø80	Ø120

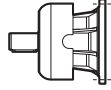

Solid input shaft with fan

	FV05B	FV06B	FV07A	FV07B	FV10B	FV11B
diam.	Ø48	Ø60	Ø60	Ø80	Ø80	Ø80

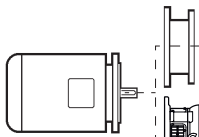

Electric motor connection
P+IEC (P71...P250)



Electric motor connection with integrated fan

PF160	PF180	PF200	PF225	PF250
--------------	--------------	--------------	--------------	--------------

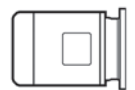

Integrated gearmotor with in-built compact electric motor
 (available up to size 307)

S2, **S3**, **S4**



Hydraulic Motor connection
 (PV option BONFIGLIOLI TECHNICAL SERVICE)

S5AP, **COAA**, **HOBA**, ...

467



Hydraulic motor MG
 (PV option BONFIGLIOLI TECHNICAL SERVICE)

477

ONLY WITH HYDRAULIC MOTOR ADAPTOR



Standard negative multidisc brake

6 = Type : 4, 5, 6
A = Braking torque : A, B, C, ...

467

Negative multidisc brake for MG hydraulic motor
SF = Without brake



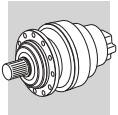



483



20 3/V_M GEARBOX DESIGNATION

3/V 10M L 3 1617 PC

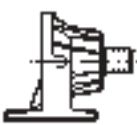
OUTPUT VERSION

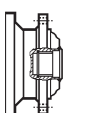
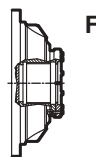
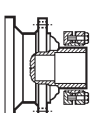
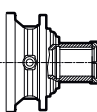
	MZ: Splined male shaft		MC: Solid keyed shaft
	HZ: Heavy duty splined male shaft		HC: Heavy duty solid keyed shaft
	PZ: Foot base with splined shaft		PC: Foot base with solid keyed shaft
	FZ / FZB: Hollow splined shaft		FZP: Hollow splined shaft with axial blockage device (recommended for shaft mounted installation)
	FP: Hollow shaft for shrink disc		
	FDK: Hollow shaft with double keyway		

REDUCTION RATIO

Fill in the value of the transm. ratio reported in the selection charts
Es. : 1/773 = 773

No. OF REDUCTIONS
3, 4

DESIGN

L = Combined 300M unit,
2 or 3 planetary stages + worm gear units

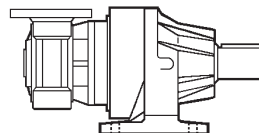

GEARBOX SIZE

00 = 3/V 00	256	05 = 3/V 05	300	10M = 3/V 10M	348	15M = 3/V 15M	396	19 = 3/V 19	438
01 = 3/V 01	266	06 = 3/V 06	312	11M = 3/V 11M	360	16M = 3/V 16M	408	21 = 3/V 21	448
03 = 3/V 03	276	07 = 3/V 07	324	13M = 3/V 13M	372	17M = 3/V 17M	418		
04 = 3/V 04	288	09 = 3/V 09	336	14M = 3/V 14M	384	18M = 3/V 18M	428		

SERIES

Combined 300M gearboxes / Worm gear units

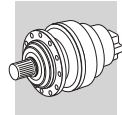

P80 B5 AF WOA ...

OPTIONS

GASKET
STANDARD = NBR
PV = Fluoro elastomer

SURFACE PROTECTION
C2 (default), C3, C4

PAINTING
RAL7042 (default), RAL5010, RAL9005, RAL9006, RAL9010

CERTIFICATES
AC, CC

OUTPUT FITTINGS



P... = Pinions



B0A = Splined bar

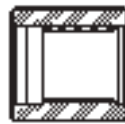

M0A = Sleeve coupling



G0A = Shrink disc



W0A = Flange

MOUNTING POSITION

DESIGN
B5, B14

ENTRATA

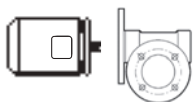

Electric motor connection **P+IEC** (P63...P180)



Input keyed shaft **HS**

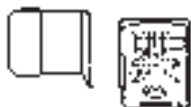



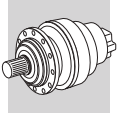



Integrated gearmotor with in-built compact electric motor **S1, S2, S3**



21 3/A GEARBOX DESIGNATION

3/A 06 L 2 69.9 PC

OUTPUT VERSION

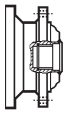
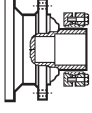
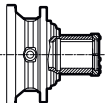
	MZ: Splined male shaft		MC: Solid keyed shaft
	HZ: Heavy duty splined male shaft		HC: Heavy duty solid keyed shaft
	PZ: Foot base with splined shaft		PC: Foot base with solid keyed shaft
	FZ / FZB: Hollow splined shaft		
	FP: Hollow shaft for shrink disc		
	FDK: Hollow shaft with double keyway		

REDUCTION RATIO

Fill in the value of the transm. ratio reported in the selection charts
 Es. : 1/19.4 = 19.4 1/175 = 175

No. OF REDUCTIONS

2

DESIGN

L = Combined 300 unit,
 1 planetary stages + A helical bevel units

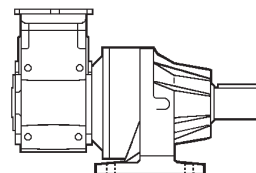

GEARBOX SIZE

- 00** = 3/A 00 (300+A10)
- 01** = 3/A 01 (301+A20)
- 03** = 3/A 03 (303+A30)
- 04** = 3/A 04 (304+A41)

257
267
277
289

- 05** = 3/A 05 (305+A41)
- 06** = 3/A 06 (306+A50)
- 07** = 3/A 07 (307+A60)

301
313
325

SERIES

Combined 300 gearboxes / A series helical bevel gear units

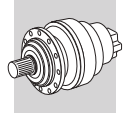

S4 EF WOA ...

OPTIONS
GASKET
STANDARD = NBR
PV = Fluoro elastomer

SURFACE PROTECTION
C2 (default), C3, C4 

PAINTING
RAL7042 (default), RAL5010, RAL9005, RAL9006, RAL9010 

CERTIFICATES
AC, CC 

OUTPUT FITTINGS



P... = Pinions B0A = Splined bar M0A = Sleeve coupling G0A = Shrink disc W0A = Flange

MOUNTING POSITION 

INPUT

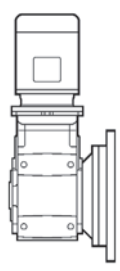

Integrated gearmotor with in-built compact electric motor S2, S3, S4

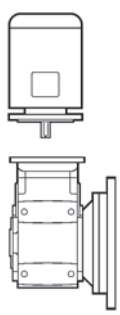

Electric motor connection P+IEC (P63...P180)

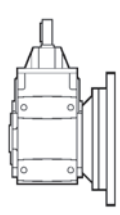

Input keyed shaft HS

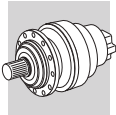

22 MOTOR DESIGNATION

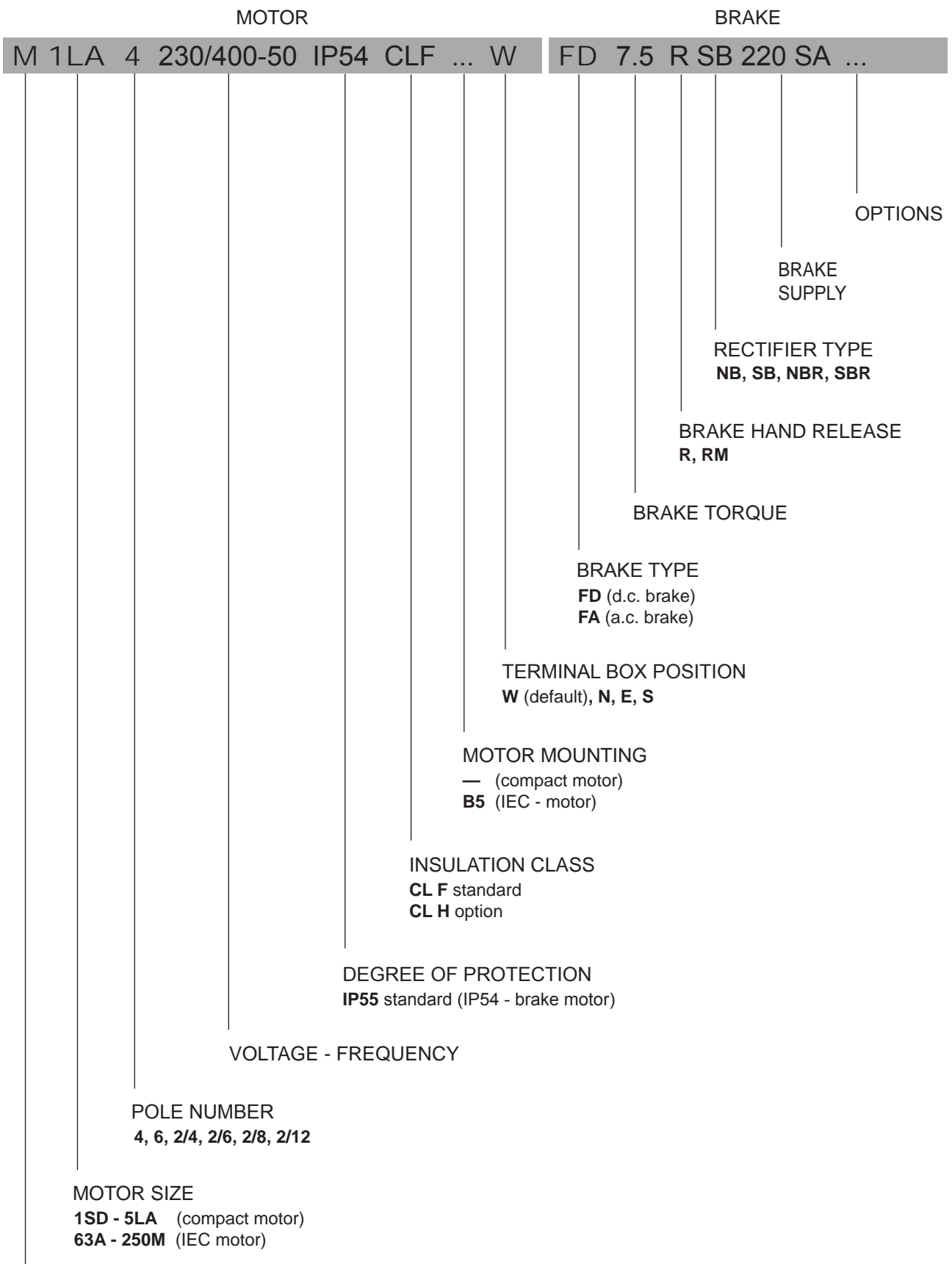

MOTOR TYPE

MX-MXN = compact 3-phase, class IE3
BX-BXN = IEC 3-phase, class IE3

ME = compact 3-phase, class IE2
BE = IEC 3-phase, class IE2

M = compact 3-phase, class IE1
BN = IEC 3-phase, class IE1

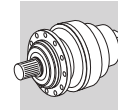

23 ADDITIONAL OPTIONS

23.1 SURFACE PROTECTION

When no specific protection class is requested, the surfaces of gearboxes are protected to at least corrosivity class C2 (UNI EN ISO 12944-2). For improved resistance to atmospheric corrosion, gearboxes can be delivered with C3 and C4 surface protection, obtained by painting the complete gearbox.

SURFACE PROTECTION	Typical environments	Maximum surface temperature	Corrosivity class according to UNI EN ISO 12944-2
C3	Urban and industrial environments with up to 100% relative humidity (medium air pollution)	120°C	C3
C4	Industrial areas, coastal areas, chemical plant, with up to 100% relative humidity (high air pollution)	120°C	C4

Gearboxes with optional protection to class C3 or C4 are available in a choice of colours. If no specific colour is requested (see the “PAINTING” option) gearboxes are finished in RAL 7042. Gearboxes can also be supplied with surface protection for corrosivity class C5 according to UNI EN ISO 12944-2. Contact our Technical Service for further details.

23.2 PAINTING

Gearboxes with optional protection to class C3 or C4 are available in the colours listed in the following table.

PAINTING	Farbe	RAL number
RAL7042*	Traffik Grey A	7042
RAL5010	Gentian Blue	5010
RAL9005	Jet Black	9005
RAL9006	White Aluminium	9006
RAL9010	Pure White	9010
RAL7035	Light Grey	7035
RAL7001	Silver Grey	7001
RAL5015	Sky Blue	5015
RAL7037	Dusty Grey	7037
RAL5024	Pastel Blue	5024

* Gearboxes are supplied in this standard colour if no other colour is specified.

NOTE – “PAINTING” options can only be specified in conjunction with “SURFACE PROTECTION” options.

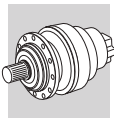

23.3 LONG TERM STOCK

In presence of the Long Term Stock option the configured product is supplied without the standard lubricant oil but with an anticorrosive protective liquid to grant the integrity and full functionality of the gear unit in those cases where the unit will not be installed immediately but it has to be stocked for a long period of time (installation later than 6 months from delivery).

The warranty conditions are valid 12 months from commissioning (with commissioning within 24 months from delivery) or 24 months from delivery without commissioning.

After 2 years of stock, the unit with the Long Term Stock option needs to be checked by Bonfiglioli assistance center. In case of a product that is not properly preserved, an offer by Bonfiglioli will be issued for a complete restore.

With the recovery activity successfully concluded, the warranty conditions restart from the 12 months of commissioning (with commissioning within 24 months from restore date) or 24 months from restore date

Gearbox size	Applicability of Long Term Stock option
300 ... 321	SLM, SLP

Applicability of the Long Term Stock option:

The Long Term Stock option can be requested in 2 versions:

- **SLM Long Term Stock_Mineral Oil:** option having anti-corrosive protective oil compatible with all mineral-based oil lubricants listed in the "Installation, operation and maintenance" Bonfiglioli manual.
- **SLP Long Term Stock_Polyglycol Oil:** option having anti-corrosive protective oil compatible with all polyglycol-based oil lubricants listed in the "Installation, operation and maintenance" Bonfiglioli manual.

Note: only one version can be selected. SLM and SLP can't coexist.

When configuring a gear unit or gearmotor with the Long Term Stock option, it is necessary to know the type of lubricating oil that will be used by the customer during the operating period (mineral or polyglycol oil). Before commissioning a Bonfiglioli product with this option, make sure that the lubricating oil filling activity takes place through the specific filling plug determined by the mounting position indicated on the plate.

With regards to gear units with lifetime lubrication (see table below), the quantity of lubricating oil to top up is not indicated in the relevant "installation, use and maintenance" Bonfiglioli manual. In this case, if the Long Term Stock option is active, it is therefore necessary to contact the Bonfiglioli assistance center to receive this information.

Gearbox size	Lubricant charge quantity
300 ... 321	

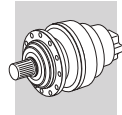

23.4 CERTIFICATES

AC - Certificate of compliance

The document certifies the compliance of the product with the purchase order and the construction in conformity with the applicable procedures of the Bonfiglioli Quality System.

CC - Inspection certificate

The document entails checking on order compliance, the visual inspection of external conditions and of mating dimensions. Checking on main functional parameters in unloaded conditions is also performed along with oil seal proofing, both in static and in running conditions. Units inspected are sampled within the shipping batch and marked individually.

23.5 TACONITE SEALS

Taconite seals are recommended for environments characterised by the presence of abrasive dust or powders. Taconite seals incorporate a combination of sealing rings, labyrinths and a grease chamber. This option is available for **FP** and **FZ** version from size 314M to 325. For detailed information please contact our Technical Service.

24 MOUNTING POSITION

The product designation is only complete when the mounting position is also specified. Please refer to table (A27) for in-line gear units and to (A28) for right angle drives.

24.1 In-line units

(A 27)

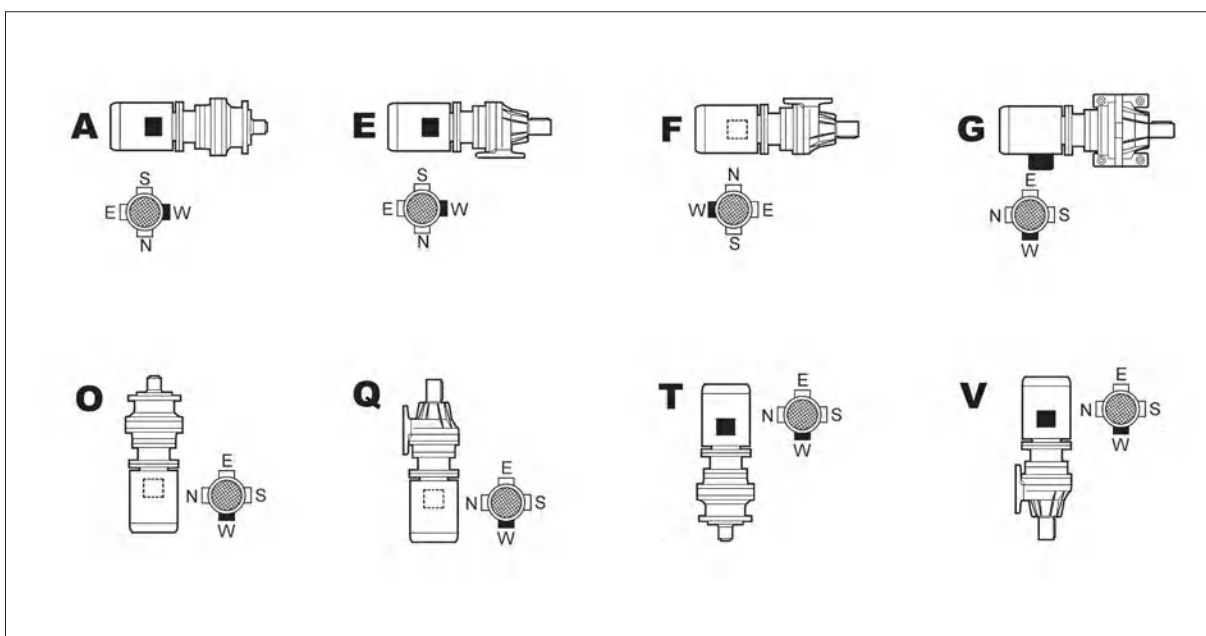

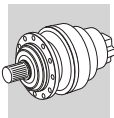

24.2 Right angle units

(A 28)

B0 - B1 - B2 - B3

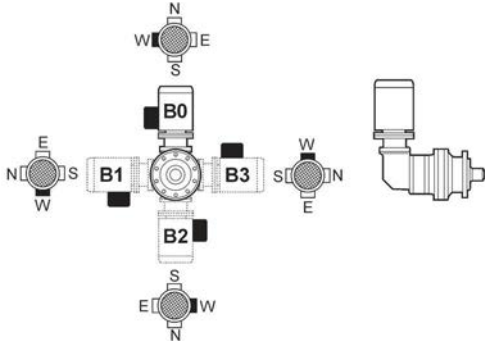

I0 - I1 - I2 - I3

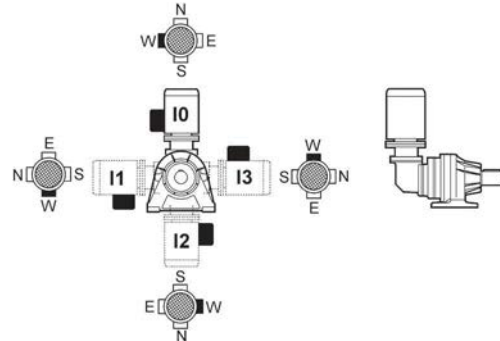

J0 - J1 - J2 - J3

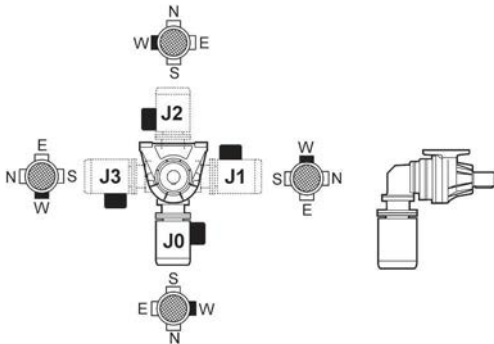

M0 - M1 - M2 - M3

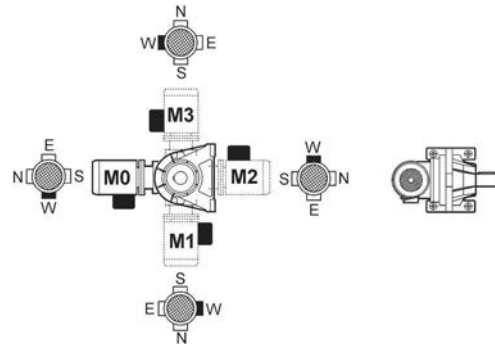

P0 - P1 - P2 - P3

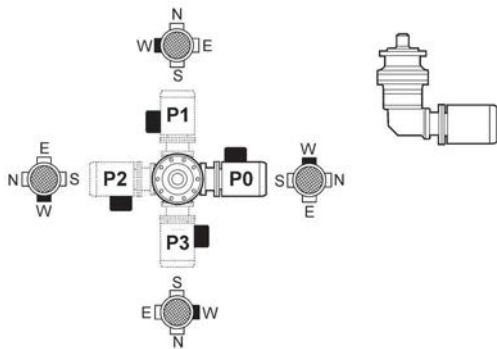

R0 - R1 - R2 - R3

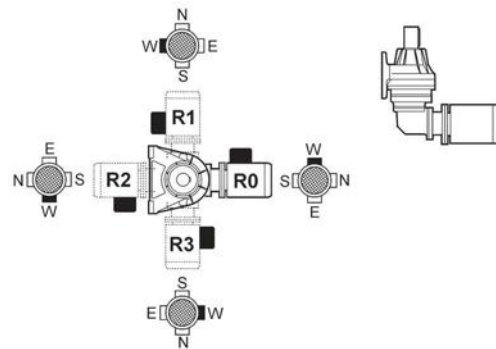

U0 - U1 - U2 - U3

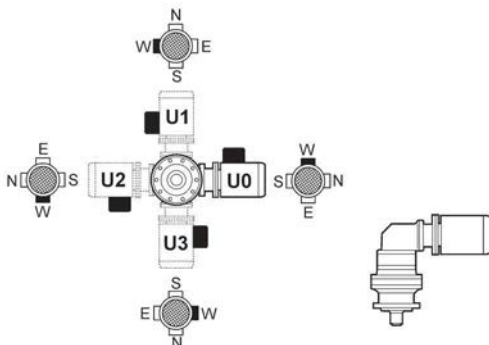

W0 - W1 - W2 - W3

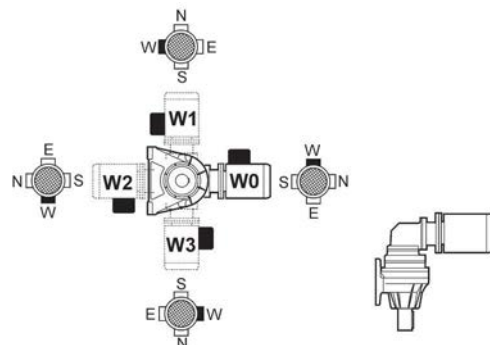

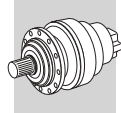

24.3 3/V_M Series

(A 29)

AA - AE - AF - AD

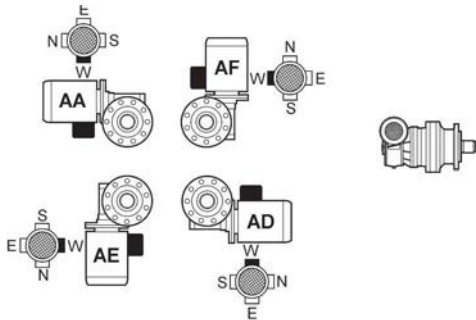

EA - EE - EF - ED

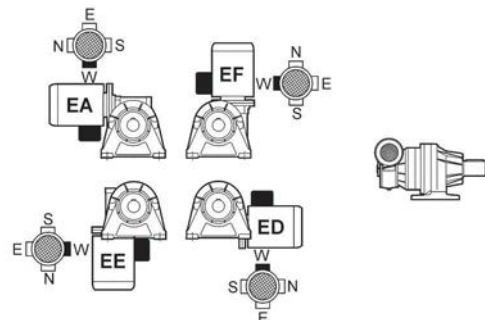

TA - TE - TF - TD

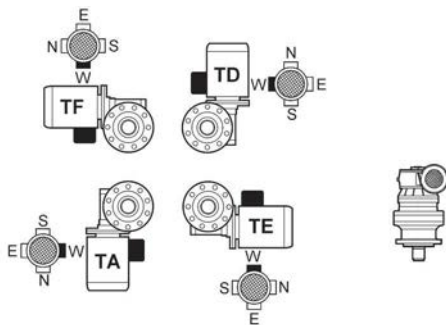

VA - VE - VF - VD

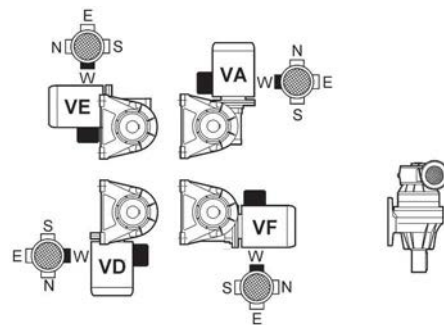

OA - OE - OF - OD

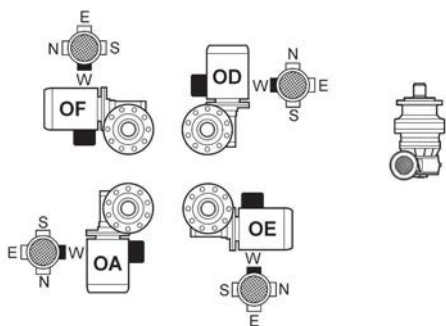

QA - QE - QF - QD

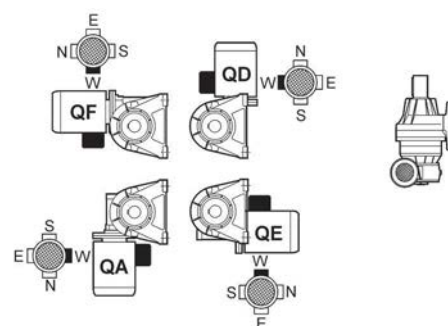

FA - FE - FF - FD

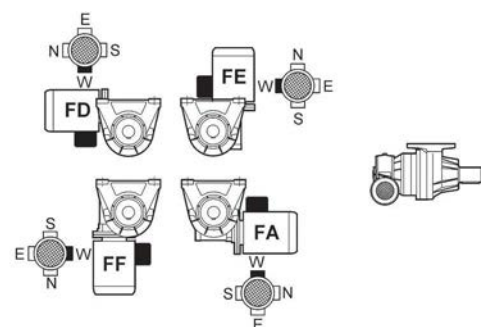

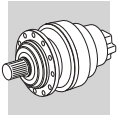

24.4 3/A Series

(A 30)

AA - AE - AF - AD

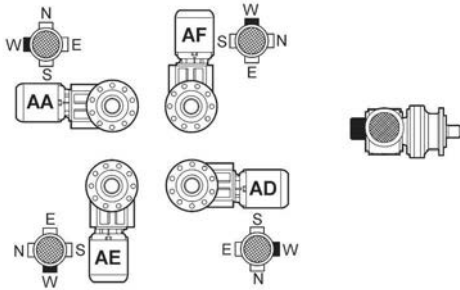

EA - EE - EF - ED

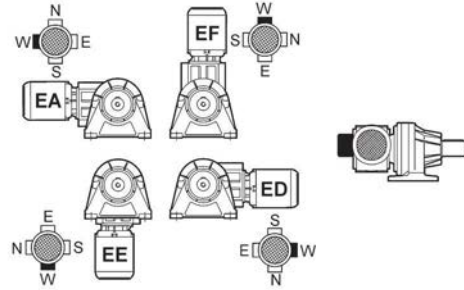

TA - TE - TF - TD

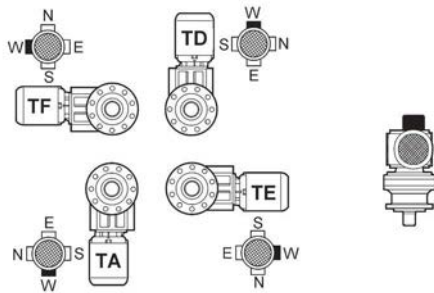

VA - VE - VF - VD

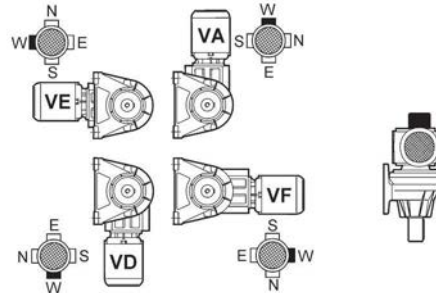

OA - OE - OF - OD

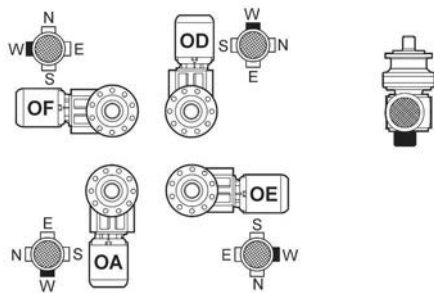

QA - QE - QF - QD

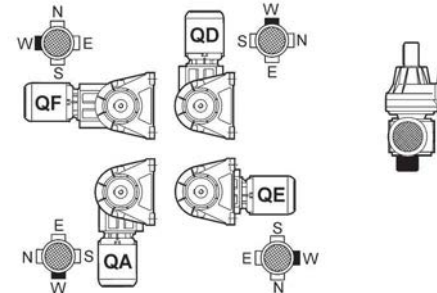

FA - FE - FF - FD

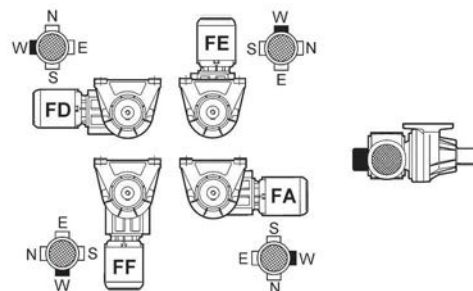

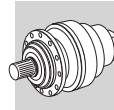

25 RATING CHARTS

A GEARMOTOR SELECTION BY POWER

A

B GEARBOX SELECTION BY APPLICATION TORQUE

B

C GEARBOX SELECTION BY NUMBER OF WORKING CYCLES

C

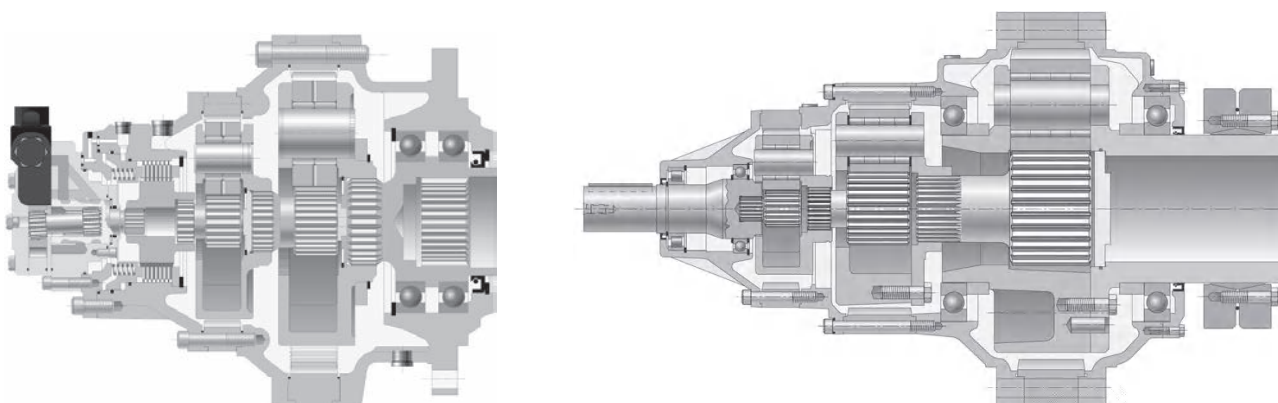
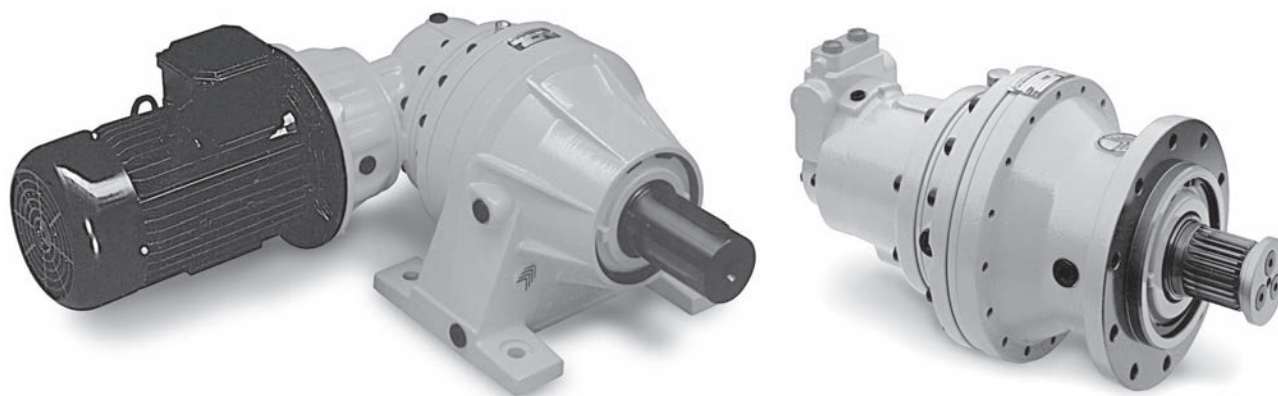

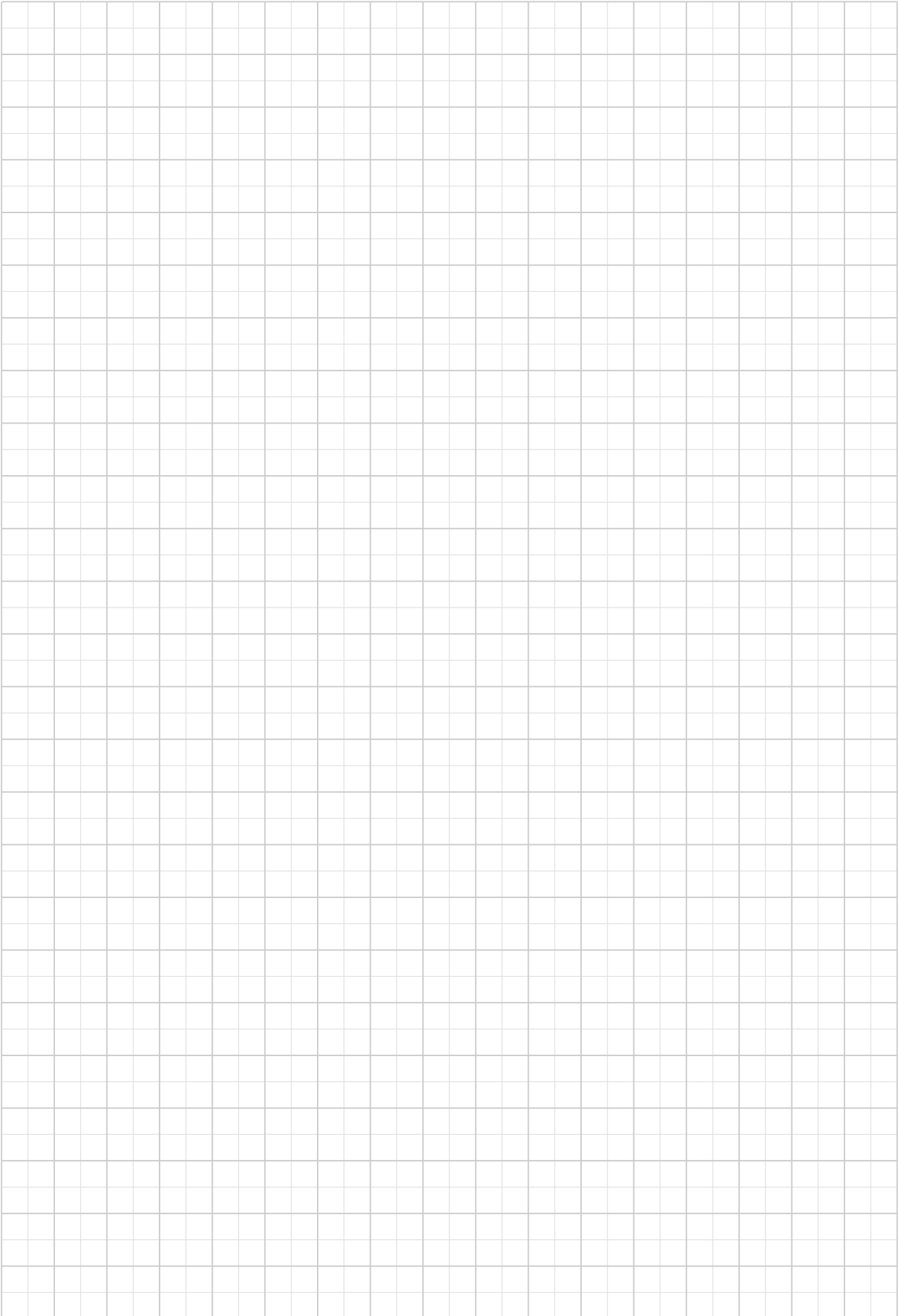
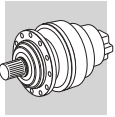

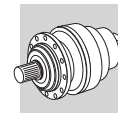

A

25.1 300M L - 300M R GEARMOTOR RATING CHARTS

Reading the rating chart.

1
 ↓

$P_1 = 11 \text{ kW}$

n ₂ min ⁻¹	M ₂ Nm	S	i	In-line		Right-angle		IEC		MC	MZ	Rn ₂ [N]			FZ	
						IE2	IE3	IE2	IE3			HC/PC	HZ/PZ	FZ		
4.7	19700	2.2	309	—	313MR4	BE160M4	BX160MB4	—	—	—	—	143100	167600	47600	370	
4.8	19400	1.2	305	—	310MR4	BE160M4	BX160MB4	—	—	—	—	78400	99500	38500	346	
4.8	20000	1.5	304	313ML3	—	BE160M4	BX160MB4	—	—	—	—	142700	167300	47300	368	
5.0	19400	1.2	295	310ML3	—	BE160M4	BX160MB4	—	—	—	—	78100	99000	38100	344	
5.0	19100	1.4	291	311ML3	—	BE160M4	BX160MB4	—	—	—	—	98000	100000	37900	356	

2
↑

3
↑

4
↑

5
↑

6
↑

7
↑

8
↑

9
↑

10
↑

11
↑

- | | |
|---|---|
| <p>1 Rating of electric motor connected to the gearbox</p> <hr/> <p>2 Gearbox output speed</p> <hr/> <p>Rated torque to the output shaft based on:</p> <p>3 - specified service factor
- 10000 h theoretical lifetime</p> <hr/> <p>4 Service factor</p> <hr/> <p>5 Gear ratio</p> <hr/> <p>6 Frame size of the in-line gear unit</p> <hr/> <p>7 Frame size of the right-angle gear unit.
NOTE: letters (B) (C) near size indication identify different angle reduction dimensions.
See dimensions pages.</p> | <p>8 IEC motor size and pole number</p> <hr/> <p>9 Integral motor frame size and pole number</p> <hr/> <p>Permitted overhung loading on output shaft, based on:</p> <p>10 - service factor $f_S=1$
- 10000 h theoretical lifetime
- speed of output n_2</p> <p>For forces not applied at shaft midpoint, see diagrams provided in the specific gearbox overall dimensioning pages</p> <hr/> <p>11 Dimensions page. Gearmotor overall dimensions refer to matches with BONFIGLIOLI motors only</p> |
|---|---|

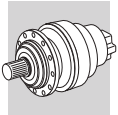

The selection of motors takes into account the requirements of Regulation 2009/125/CE (see section M of this catalogue). When the motor rated power is below 0,12kW, **BN/M** motors can be provided. Starting from 1st July 2021 the regulation 2009/125/CE will apply also to motors equipped with brake, and 8 poles motors.

A

$P_1 = 0.25 \text{ kW}$

n ₂ min ⁻¹	M ₂ Nm	S	i	[Icon]		[Icon]		[Icon]		[Icon]		Rn ₂ [N]					[Icon]
				IE1	IE2	IE1	IE2	MC	MZ	HC/PC	HZ/PZ	FZ					
0.47	4470	1.6	2916	306L4	—	BN71A4	BE71A4	—	—	35000	39900	79800	92100	35000	308		
0.57	3710	3.0	2423	307L4	—	BN71A4	BE71A4	—	—	40900	51100	92100	121100	45000	320		
0.59	3580	2.0	2337	306L4	—	BN71A4	BE71A4	—	—	33900	38700	77300	89300	35000	308		
0.62	3440	1.1	2243	305L4	—	BN71A4	BE71A4	—	—	28300	32400	54600	64700	24000	296		
0.67	3180	2.2	2074	306L4	—	BN71A4	BE71A4	—	—	33300	38000	76000	87800	35000	308		
0.69	3050	0.9	1991	303L4	—	BN71A4	BE71A4	—	—	27800	31800	53700	63700	24000	272		
0.69	3050	1.2	1991	304L4	—	BN71A4	BE71A4	—	—	27800	31800	53700	63700	24000	284		
0.69	3050	1.8	1991	305L4	—	BN71A4	BE71A4	—	—	27800	31800	53700	63700	24000	296		
0.74	2840	1.7	1854	305L4	—	BN71A4	BE71A4	—	—	27600	31500	53200	63000	24000	296		
0.76	2780	1.1	1815	304L4	—	BN71A4	BE71A4	—	—	27500	31400	53000	62800	24000	284		
0.87	2430	0.9	1586	303L4	—	BN71A4	BE71A4	—	—	27000	30800	52000	61600	24000	272		
0.87	2430	1.6	1586	304L4	—	BN71A4	BE71A4	—	—	27000	30800	52000	61600	24000	284		
0.87	2430	2.0	1586	305L4	—	BN71A4	BE71A4	—	—	27000	30800	52000	61600	24000	296		
1.0	2100	1.2	1370	303L4	—	BN71A4	BE71A4	—	—	26400	30200	50900	60300	23900	272		
1.0	2060	1.8	1344	304L4	—	BN71A4	BE71A4	—	—	26300	30100	50800	60200	23800	284		
1.0	2100	2.2	1370	305L4	—	BN71A4	BE71A4	—	—	26400	30200	50900	60300	23900	296		
1.1	1950	1.2	1275	301L4	—	BN71A4	BE71A4	—	—	8090	8090	26800	29200	7790	262		
1.1	1960	1.4	1278	303L4	—	BN71A4	BE71A4	—	—	26100	29900	50400	59700	23400	272		
1.1	1950	2.0	1271	304L4	—	BN71A4	BE71A4	—	—	26100	29900	50400	59700	23400	284		
1.1	1960	2.8	1278	305L4	—	BN71A4	BE71A4	—	—	26100	29900	50400	59700	23400	296		
1.2	1700	1.0	1108	301L4	—	BN71A4	BE71A4	—	—	7930	7930	26200	28700	7440	262		
1.2	1780	1.6	1164	304L4	—	BN71A4	BE71A4	—	—	25800	29500	49700	59000	22700	284		
1.3	1680	1.4	1098	303L4	—	BN71A4	BE71A4	—	—	25600	29200	49300	58500	22200	272		
1.3	1680	2.7	1098	305L4	—	BN71A4	BE71A4	—	—	25600	29200	49300	58500	22200	296		
1.4	1560	1.5	1022	301L4	—	BN71A4	BE71A4	—	—	7840	7840	25900	28300	7240	262		
1.4	1560	1.8	1018	303L4	—	BN71A4	BE71A4	—	—	25300	28900	48800	57800	21700	272		
1.4	1560	2.5	1018	304L4	—	BN71A4	BE71A4	—	—	25300	28900	48800	57800	21700	284		
1.5	1440	1.6	942	301L4	—	BN71A4	BE71A4	—	—	7750	7750	25600	28000	7040	262		
1.5	1370	1.6	896	303L4	—	BN71A4	BE71A4	—	—	24800	28400	47900	56800	20800	272		
1.7	1250	0.9	819	300L4	—	BN71A4	BE71A4	—	—	7590	7590	25100	29200	6720	252		
1.7	1250	1.8	819	301L4	—	BN71A4	BE71A4	—	—	7590	7590	25100	27400	6720	262		
1.7	1250	2.2	816	303L4	—	BN71A4	BE71A4	—	—	24500	28000	47300	56000	20100	272		
1.7	1220	1.5	797	—	303R4	BN71A4	BE71A4	—	—	24400	27900	47100	55900	20000	274		
1.7	1260	1.8	824	—	303R4	BN71A4	BE71A4	—	—	24500	28100	47300	56100	20200	274		
1.7	1220	2.9	797	—	305R4	BN71A4	BE71A4	—	—	24400	27900	47100	55900	20000	298		
1.8	1160	1.0	755	300L4	—	BN71A4	BE71A4	—	—	7500	7500	24800	28900	6540	252		
1.8	1160	1.9	755	301L4	—	BN71A4	BE71A4	—	—	7500	7500	24800	27100	6540	262		
1.8	1170	1.3	766	—	301R4	BN71A4	BE71A4	—	—	7520	7520	24900	27200	6580	264		
1.9	1100	2.0	718	303L4	—	BN71A4	BE71A4	—	—	24100	27500	46400	55000	19300	272		
2.0	1080	2.5	702	304L4	—	BN71A4	BE71A4	—	—	24000	27400	46300	54800	19200	284		
2.0	1070	2.5	699	—	304R4	BN71A4	BE71A4	—	—	24000	27400	46300	54800	19100	286		
2.1	990	2.3	649	303L4	—	BN71A4	BE71A4	—	—	23700	27100	45800	54200	18700	272		
2.1	1010	2.1	659	—	303R4	BN71A4	BE71A4	—	—	23800	27200	45900	54400	18800	274		
2.2	940	1.2	616	300L4	—	BN71A4	BE71A4	—	—	7290	7290	24100	28000	6110	252		
2.2	940	2.3	616	301L4	—	BN71A4	BE71A4	—	—	7290	7290	24100	26400	6110	262		
2.3	940	1.6	613	—	301R4	BN71A4	BE71A4	—	—	7290	7290	24100	26300	6100	264		
2.4	870	2.8	567	—	303R4	BN71A4	BE71A4	—	—	23300	26600	44900	53200	17800	274		
2.5	850	1.3	558	300L4	—	BN71A4	BE71A4	—	—	7190	7190	23800	27600	5920	252		

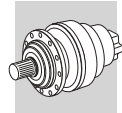

$P_1 = 0.25 \text{ kW}$

n_2 min ⁻¹	M_2 Nm	S	i	IE1		IE2		Rn ₂ [N]					FZ	Icon	
				MC	MZ	HC/PC	HZ/PZ	FZ							
2.5	850	2.5	558	301L4	—	BN71A4	BE71A4	—	—	7190	7190	23800	26000	5920	262
2.5	860	3.0	560	—	304R4	BN71A4	BE71A4	—	—	23200	26500	44800	53100	17800	286
2.6	810	2.6	528	—	303R4	BN71A4	BE71A4	—	—	23000	26300	44400	52700	17400	274
2.8	760	1.4	494	300L4	—	BN71A4	BE71A4	—	—	7060	7060	23400	27200	5680	252
2.8	750	1.0	491	—	300R4	BN71A4	BE71A4	—	—	7060	7060	23300	27100	5670	254
2.8	760	2.8	494	301L4	—	BN71A4	BE71A4	—	—	7060	7060	23400	25500	5680	262
2.8	750	1.9	491	—	301R4	BN71A4	BE71A4	—	—	7060	7060	23300	25500	5670	264
3.0	690	1.5	453	—	300R4	BN71A4	BE71A4	—	—	6980	6980	23100	26800	5520	254
3.0	690	2.8	453	—	301R4	BN71A4	BE71A4	—	—	6980	6980	23100	25200	5520	264
3.1	680	1.5	447	300L4	—	BN71A4	BE71A4	—	—	6960	6960	23000	26800	5490	252
3.4	620	1.1	403	300L4	—	BN71A4	BE71A4	—	—	6860	6860	22700	26400	5310	252
3.4	620	2.2	403	301L4	—	BN71A4	BE71A4	—	—	6860	6860	22700	24800	5310	262
3.5	600	1.1	394	—	300R4	BN71A4	BE71A4	—	—	6840	6840	22600	26300	5270	254
3.5	600	2.3	394	—	301R4	BN71A4	BE71A4	—	—	6840	6840	22600	24700	5270	264
3.5	610	2.8	389	303L3	—	BN71A4	BE71A4	—	—	22100	25200	42500	50400	15700	272
3.7	590	1.2	374	300L3	—	BN71A4	BE71A4	—	—	6790	6790	22500	26100	5180	252
3.7	590	2.3	374	301L3	—	BN71A4	BE71A4	—	—	6790	6790	22500	24500	5180	262
3.8	560	1.8	363	—	300R4	BN71A4	BE71A4	—	—	6760	6760	22400	26000	5130	254
4.2	510	1.9	330	300L4	—	BN71A4	BE71A4	—	—	6670	6670	22100	25600	4970	252
4.6	470	1.4	299	300L3	—	BN71A4	BE71A4	—	—	6570	6570	21700	25300	4810	252
4.6	470	2.8	299	301L3	—	BN71A4	BE71A4	—	—	6570	6570	21700	23800	4810	262
4.7	450	2.2	291	—	300R4	BN71A4	BE71A4	—	—	6550	6550	21700	25200	4760	254
5.1	410	2.3	268	—	300R4	BN71A4	BE71A4	—	—	6500	6500	21500	25000	4630	254
5.8	380	1.7	240	300L3	—	BN71A4	BE71A4	—	—	6500	6500	21500	25000	4460	252
5.8	360	1.8	237	—	300R4	BN71A4	BE71A4	—	—	6500	6500	21500	25000	4450	254
6.2	350	2.6	221	300L3	—	BN71A4	BE71A4	—	—	6500	6500	21500	25000	4340	252
6.4	330	2.8	215	—	300R4	BN71A4	BE71A4	—	—	6500	6500	21500	25000	4300	254
7.2	300	2.1	192	300L3	—	BN71A4	BE71A4	—	—	6500	6500	21500	25000	4150	252
9.6	220	3.0	143	—	300R4	BN71A4	BE71A4	—	—	6500	6500	21500	25000	3760	254
10.4	210	2.6	133	—	300R3	BN71A4	BE71A4	—	—	6420	6420	21300	24700	3670	254



$P_1 = 0.37 \text{ kW}$

n_2 min ⁻¹	M_2 Nm	S	i	IE1		IE2		Rn ₂ [N]					FZ	Icon	
				MC	MZ	HC/PC	HZ/PZ	FZ							
0.47	6710	1.0	2916	306L4	—	BN71B4	BE71B4	M1SD4	ME1SB4	35000	40000	79900	92200	35000	308
0.57	5580	2.0	2423	307L4	—	BN71B4	BE71B4	M1SD4	ME1SB4	41000	51200	92200	121200	45000	320
0.59	5380	1.3	2337	306L4	—	BN71B4	BE71B4	M1SD4	ME1SB4	34000	38700	77400	89400	35000	308
0.66	4770	1.5	2074	306L4	—	BN71B4	BE71B4	M1SD4	ME1SB4	33400	38100	76100	87900	35000	308
0.69	4580	1.2	1991	305L4	—	BN71B4	BE71B4	M1SD4	ME1SB4	27900	31900	53800	63700	24000	296
0.74	4270	1.1	1854	305L4	—	BN71B4	BE71B4	M1SD4	ME1SB4	27600	31500	53200	63100	24000	296
0.74	4240	2.4	1843	306L4	—	BN71B4	BE71B4	M1SD4	ME1SB4	32800	37400	74800	86400	35000	308
0.86	3650	1.1	1586	304L4	—	BN71B4	BE71B4	M1SD4	ME1SB4	27000	30800	52000	61700	24000	284
0.86	3650	1.3	1586	305L4	—	BN71B4	BE71B4	M1SD4	ME1SB4	27000	30800	52000	61700	24000	296
0.86	3680	2.3	1597	306L4	—	BN71B4	BE71B4	M1SD4	ME1SB4	32200	36700	73300	84600	35000	308
0.93	3390	3.0	1475	306L4	—	BN71B4	BE71B4	M1SD4	ME1SB4	31800	36200	72500	83700	35000	308
1.0	3090	1.2	1344	304L4	—	BN71B4	BE71B4	M1SD4	ME1SB4	26400	30100	50800	60200	23800	284
1.0	3150	1.5	1370	305L4	—	BN71B4	BE71B4	M1SD4	ME1SB4	26400	30200	51000	60400	24000	296
1.1	2940	1.0	1278	303L4	—	BN71B4	BE71B4	M1SD4	ME1SB4	26200	29900	50500	59800	23500	272
1.1	2930	1.3	1271	304L4	—	BN71B4	BE71B4	M1SD4	ME1SB4	26100	29900	50400	59800	23400	284
1.1	2940	1.9	1278	305L4	—	BN71B4	BE71B4	M1SD4	ME1SB4	26200	29900	50500	59800	23500	296
1.1	2940	2.9	1279	306L4	—	BN71B4	BE71B4	M1SD4	ME1SB4	31200	35500	71000	82000	34200	308
1.2	2530	0.9	1098	303L4	—	BN71B4	BE71B4	M1SD4	ME1SB4	25600	29300	49400	58500	22300	272
1.2	2680	1.1	1164	304L4	—	BN71B4	BE71B4	M1SD4	ME1SB4	25800	29500	49800	59000	22700	284
1.2	2530	1.8	1098	305L4	—	BN71B4	BE71B4	M1SD4	ME1SB4	25600	29300	49400	58500	22300	296
1.3	2350	1.0	1022	301L4	—	BN71B4	BE71B4	M1SD4	ME1SB4	7840	7840	25900	28400	7250	262
1.3	2340	1.2	1018	303L4	—	BN71B4	BE71B4	M1SD4	ME1SB4	25300	29000	48900	57900	21700	272
1.3	2340	1.7	1018	304L4	—	BN71B4	BE71B4	M1SD4	ME1SB4	25300	29000	48900	57900	21700	284
1.3	2340	2.3	1018	305L4	—	BN71B4	BE71B4	M1SD4	ME1SB4	25300	29000	48900	57900	21700	296
1.5	2170	1.1	942	301L4	—	BN71B4	BE71B4	M1SD4	ME1SB4	7750	7750	25600	28000	7060	262
1.5	2060	1.1	896	303L4	—	BN71B4	BE71B4	M1SD4	ME1SB4	24900	28400	48000	56900	20800	272
1.5	2060	2.1	896	305L4	—	BN71B4	BE71B4	M1SD4	ME1SB4	24900	28400	48000	56900	20800	296

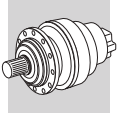



$P_1 = 0.37 \text{ kW}$

n_2 min ⁻¹	M_2 Nm	S	i			IE1		IE2		R _{n2} [N]					
						IE1	IE2	IE1	IE2	MC	MZ	HC/PC	HZ/PZ	FZ	
1.7	1880	1.2	819	301L4	—	BN71B4	BE71B4	M1SD4	ME1SB4	7600	7600	25100	27500	6740	262
1.7	1880	1.5	816	303L4	—	BN71B4	BE71B4	M1SD4	ME1SB4	24500	28000	47300	56100	20200	272
1.7	1830	1.0	797	—	303R4	BN71B4	BE71B4	M1SD4	ME1SB4	24500	28000	47200	55900	20000	274
1.7	1900	1.2	824	—	303R4	BN71B4	BE71B4	M1SD4	ME1SB4	24600	28100	47400	56200	20300	274
1.7	1880	2.0	816	304L4	—	BN71B4	BE71B4	M1SD4	ME1SB4	24500	28000	47300	56100	20200	284
1.7	1880	2.9	816	305L4	—	BN71B4	BE71B4	M1SD4	ME1SB4	24500	28000	47300	56100	20200	296
1.7	1830	1.9	797	—	305R4	BN71B4	BE71B4	M1SD4	ME1SB4	24500	28000	47200	55900	20000	298
1.7	1900	2.3	824	—	305R4	BN71B4	BE71B4	M1SD4	ME1SB4	24600	28100	47400	56200	20300	298
1.8	1740	1.3	755	301L4	—	BN71B4	BE71B4	M1SD4	ME1SB4	7510	7510	24800	27200	6560	262
1.9	1650	1.3	718	303L4	—	BN71B4	BE71B4	M1SD4	ME1SB4	24100	27500	46500	55100	19400	272
1.9	1650	2.5	718	305L4	—	BN71B4	BE71B4	M1SD4	ME1SB4	24100	27500	46500	55100	19400	296
2.0	1620	1.7	702	304L4	—	BN71B4	BE71B4	M1SD4	ME1SB4	24000	27500	46300	54900	19200	284
2.0	1610	1.7	699	—	304R4	BN71B4	BE71B4	M1SD4	ME1SB4	24000	27400	46300	54900	19200	286
2.1	1490	1.6	649	303L4	—	BN71B4	BE71B4	M1SD4	ME1SB4	23800	27100	45800	54300	18700	272
2.1	1520	1.4	659	—	303R4	BN71B4	BE71B4	M1SD4	ME1SB4	23800	27200	45900	54400	18800	274
2.1	1490	2.4	649	304L4	—	BN71B4	BE71B4	M1SD4	ME1SB4	23800	27100	45800	54300	18700	284
2.1	1520	2.7	659	—	305R4	BN71B4	BE71B4	M1SD4	ME1SB4	23800	27200	45900	54400	18800	298
2.2	1420	1.5	616	301L4	—	BN71B4	BE71B4	M1SD4	ME1SB4	7300	7300	24100	26400	6130	262
2.2	1410	1.1	613	—	301R4	BN71B4	BE71B4	M1SD4	ME1SB4	7290	7290	24100	26400	6120	264
2.4	1300	1.9	567	—	303R4	BN71B4	BE71B4	M1SD4	ME1SB4	23300	26600	44900	53300	17900	274
2.4	1290	2.0	560	—	304R4	BN71B4	BE71B4	M1SD4	ME1SB4	23300	26600	44800	53200	17800	286
2.5	1280	1.7	558	301L4	—	BN71B4	BE71B4	M1SD4	ME1SB4	7190	7190	23800	26000	5930	262
2.5	1280	2.2	556	303L4	—	BN71B4	BE71B4	M1SD4	ME1SB4	23200	26600	44800	53100	17800	272
2.5	1280	2.9	556	304L4	—	BN71B4	BE71B4	M1SD4	ME1SB4	23200	26600	44800	53100	17800	284
2.6	1220	1.7	528	—	303R4	BN71B4	BE71B4	M1SD4	ME1SB4	23100	26400	44500	52700	17500	274
2.8	1140	0.9	494	300L4	—	BN71B4	BE71B4	M1SD4	ME1SB4	7070	7070	23400	27200	5690	252
2.8	1140	1.8	494	301L4	—	BN71B4	BE71B4	M1SD4	ME1SB4	7070	7070	23400	25600	5690	262
2.8	1130	1.3	491	—	301R4	BN71B4	BE71B4	M1SD4	ME1SB4	7070	7070	23400	25500	5680	264
2.8	1130	2.4	492	303L4	—	BN71B4	BE71B4	M1SD4	ME1SB4	22800	26100	44000	52200	17100	272
3.0	1040	1.0	453	—	300R4	BN71B4	BE71B4	M1SD4	ME1SB4	6980	6980	23100	26900	5530	254
3.0	1040	1.9	453	—	301R4	BN71B4	BE71B4	M1SD4	ME1SB4	6980	6980	23100	25300	5530	264
3.0	1040	2.2	452	—	303R4	BN71B4	BE71B4	M1SD4	ME1SB4	22600	25800	43500	51600	16600	274
3.1	1030	1.0	447	300L4	—	BN71B4	BE71B4	M1SD4	ME1SB4	6970	6970	23100	26800	5510	252
3.1	1030	2.0	447	301L4	—	BN71B4	BE71B4	M1SD4	ME1SB4	6970	6970	23100	25200	5510	262
3.1	1030	2.7	446	303L4	—	BN71B4	BE71B4	M1SD4	ME1SB4	22500	25700	43400	51500	16500	272
3.2	1010	2.5	426	304L3	—	BN71B4	BE71B4	M1SD4	ME1SB4	22400	25600	43100	51100	16300	284
3.3	950	2.5	413	303L4	—	BN71B4	BE71B4	M1SD4	ME1SB4	22300	25500	42900	50900	16100	272
3.3	950	2.6	414	—	304R4	BN71B4	BE71B4	M1SD4	ME1SB4	22300	25500	43000	50900	16100	286
3.4	930	1.5	403	301L4	—	BN71B4	BE71B4	M1SD4	ME1SB4	6870	6870	22700	24800	5320	262
3.4	950	2.1	402	303L3	—	BN71B4	BE71B4	M1SD4	ME1SB4	22200	25300	42800	50700	15900	272
3.5	910	1.5	394	—	301R4	BN71B4	BE71B4	M1SD4	ME1SB4	6850	6850	22600	24700	5280	264
3.5	920	1.8	389	303L3	—	BN71B4	BE71B4	M1SD4	ME1SB4	22100	25200	42600	50500	15800	272
3.5	900	2.2	390	—	303R4	BN71B4	BE71B4	M1SD4	ME1SB4	22100	25200	42600	50500	15800	274
3.7	890	1.5	374	301L3	—	BN71B4	BE71B4	M1SD4	ME1SB4	6800	6800	22500	24600	5190	262
3.8	840	1.2	363	—	300R4	BN71B4	BE71B4	M1SD4	ME1SB4	6770	6770	22400	26000	5140	254
3.8	840	2.4	363	—	301R4	BN71B4	BE71B4	M1SD4	ME1SB4	6770	6770	22400	24500	5140	264
3.8	840	2.8	364	—	303R4	BN71B4	BE71B4	M1SD4	ME1SB4	21900	25000	42200	50000	15400	274
4.1	760	1.3	330	300L4	—	BN71B4	BE71B4	M1SD4	ME1SB4	6680	6680	22100	25700	4980	252
4.1	760	2.6	330	301L4	—	BN71B4	BE71B4	M1SD4	ME1SB4	6680	6680	22100	24100	4980	262
4.1	770	3.0	336	—	303R4	BN71B4	BE71B4	M1SD4	ME1SB4	21600	24700	41700	49400	15000	274
4.3	760	2.5	321	303L3	—	BN71B4	BE71B4	M1SD4	ME1SB4	21500	24600	41400	49100	14800	272
4.4	720	2.6	313	—	303R4	BN71B4	BE71B4	M1SD4	ME1SB4	21400	24500	41300	48900	14700	274
4.6	710	0.9	299	300L3	—	BN71B4	BE71B4	M1SD4	ME1SB4	6580	6580	21800	25300	4820	252
4.6	710	1.9	299	301L3	—	BN71B4	BE71B4	M1SD4	ME1SB4	6580	6580	21800	23800	4820	262
4.7	670	1.4	291	—	300R4	BN71B4	BE71B4	M1SD4	ME1SB4	6560	6560	21700	25200	4770	254
4.7	670	2.9	291	—	301R4	BN71B4	BE71B4	M1SD4	ME1SB4	6560	6560	21700	23700	4770	264
5.1	620	1.5	268	—	300R4	BN71B4	BE71B4	M1SD4	ME1SB4	6500	6500	21500	25000	4650	254
5.7	570	1.1	240	300L3	—	BN71B4	BE71B4	M1SD4	ME1SB4	6500	6500	21500	25000	4470	252
5.7	570	2.3	240	301L3	—	BN71B4	BE71B4	M1SD4	ME1SB4	6500	6500	21500	23500	4470	262
5.8	550	1.2	237	—	300R4	BN71B4	BE71B4	M1SD4	ME1SB4	6500	6500	21500	25000	4460	254
5.8	550	2.4	237	—	301R4	BN71B4	BE71B4	M1SD4	ME1SB4	6500	6500	21500	23500	4460	264
6.2	520	1.8	221	300L3	—	BN71B4	BE71B4	M1SD4	ME1SB4	6500	6500	21500	25000	4350	252
6.4	490	1.9	215	—	300R4	BN71B4	BE71B4	M1SD4	ME1SB4	6500	6500	21500	25000	4310	254
7.1	460	1.4	192	300L3	—	BN71B4	BE71B4	M1SD4	ME1SB4	6500	6500	21500	25000	4160	252
7.1	460	2.9	192	301L3	—	BN71B4	BE71B4	M1SD4	ME1SB4	6500	6500	21500	23500	4160	262

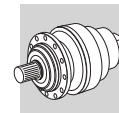

$P_1 = 0.37 \text{ kW}$

n_2 min ⁻¹	M_2 Nm	S	i	IE1		IE2		R _{n2} [N]					FZ	Icon	
				MC	MZ	HC/PC	HZ/PZ	FZ							
7.7	420	2.1	177	300L3	—	BN71B4	BE71B4	M1SD4	ME1SB4	6500	6500	21500	25000	4040	252
7.8	400	2.2	175	—	300R4	BN71B4	BE71B4	M1SD4	ME1SB4	6500	6500	21500	25000	4030	254
8.6	370	2.4	159	—	300R4	BN71B4	BE71B4	M1SD4	ME1SB4	6500	6500	21500	25000	3900	254
9.6	330	2.0	143	—	300R4	BN71B4	BE71B4	M1SD4	ME1SB4	6500	6500	21500	25000	3770	254
9.7	340	2.6	142	300L3	—	BN71B4	BE71B4	M1SD4	ME1SB4	6500	6500	21500	25000	3760	252
10.3	320	1.7	133	—	300R3	BN71B4	BE71B4	M1SD4	ME1SB4	6430	6430	21300	24800	3680	254
10.5	310	2.8	131	300L3	—	BN71B4	BE71B4	M1SD4	ME1SB4	6400	6400	21200	24700	3660	252
10.6	300	2.9	130	—	300R4	BN71B4	BE71B4	M1SD4	ME1SB4	6380	6380	21100	24600	3650	254
11.8	270	2.4	116	300L3	—	BN71B4	BE71B4	M1SD4	ME1SB4	6150	6150	20400	23800	3510	252
12.9	250	2.6	106	—	300R3	BN71B4	BE71B4	M1SD4	ME1SB4	5980	5980	19900	23200	3410	254

$P_1 = 0.55 \text{ kW}$

n_2 min ⁻¹	M_2 Nm	S	i	IE1		IE2		R _{n2} [N]					FZ	Icon	
				MC	MZ	HC/PC	HZ/PZ	FZ							
0.55	8490	2.8	2523	310ML4	—	BN80A4	BE80A4	—	—	—	—	106900	135500	65000	344
0.57	8150	1.3	2423	307L4	—	BN80A4	BE80A4	M1LA4	ME2SA4	40900	51100	92000	121000	45000	320
0.57	8150	2.1	2423	309L4	—	BN80A4	BE80A4	—	—	—	—	94000	121000	36000	334
0.67	6980	1.0	2074	306L4	—	BN80A4	BE80A4	M1LA4	ME2SA4	33300	38000	76000	87700	35000	308
0.68	6870	2.1	2041	307L4	—	BN80A4	BE80A4	M1LA4	ME2SA4	39900	49900	89700	118100	45000	320
0.69	6740	2.5	2003	309L4	—	BN80A4	BE80A4	—	—	—	—	91500	117700	36000	334
0.75	6200	1.6	1843	306L4	—	BN80A4	BE80A4	M1LA4	ME2SA4	32800	37300	74700	86200	35000	308
0.79	5950	2.6	1767	307L4	—	BN80A4	BE80A4	M1LA4	ME2SA4	39100	48800	87900	115700	45000	320
0.81	5800	2.9	1723	309L4	—	BN80A4	BE80A4	—	—	—	—	89500	115200	36000	334
0.87	5370	1.6	1597	306L4	—	BN80A4	BE80A4	M1LA4	ME2SA4	32100	36600	73200	84500	35000	308
0.87	5350	2.8	1591	307L4	—	BN80A4	BE80A4	M1LA4	ME2SA4	38500	48100	86600	113900	45000	320
0.94	4960	2.0	1475	306L4	—	BN80A4	BE80A4	M1LA4	ME2SA4	31700	36200	72300	83500	35000	308
1.0	4610	1.0	1370	305L4	—	BN80A4	BE80A4	M1LA4	ME2SA4	26400	30100	50900	60300	23900	296
1.1	4280	0.9	1271	304L4	—	BN80A4	BE80A4	M1LA4	ME2SA4	26100	29800	50300	59600	23300	284
1.1	4300	1.3	1278	305L4	—	BN80A4	BE80A4	M1LA4	ME2SA4	26100	29800	50400	59700	23300	296
1.1	4300	2.0	1279	306L4	—	BN80A4	BE80A4	M1LA4	ME2SA4	31100	35400	70900	81800	34000	308
1.1	4290	2.9	1274	307L4	—	BN80A4	BE80A4	M1LA4	ME2SA4	37300	46600	83900	110400	43700	320
1.3	3690	1.2	1098	305L4	—	BN80A4	BE80A4	M1LA4	ME2SA4	25600	29200	49300	58400	22200	296
1.3	3680	2.1	1095	306L4	—	BN80A4	BE80A4	M1LA4	ME2SA4	30400	34700	69300	80000	32300	308
1.4	3430	1.1	1018	304L4	—	BN80A4	BE80A4	M1LA4	ME2SA4	25300	28900	48800	57800	21600	284
1.4	3430	1.6	1018	305L4	—	BN80A4	BE80A4	M1LA4	ME2SA4	25300	28900	48800	57800	21600	296
1.4	3410	2.8	1015	306L4	—	BN80A4	BE80A4	M1LA4	ME2SA4	30100	34300	68600	79200	31500	308
1.6	3020	1.4	896	305L4	—	BN80A4	BE80A4	M1LA4	ME2SA4	24800	28400	47900	56700	20700	296
1.6	2950	2.6	877	306L4	—	BN80A4	BE80A4	M1LA4	ME2SA4	29500	33600	67200	77500	30000	308
1.7	2750	1.0	816	303L4	—	BN80A4	BE80A4	M1LA4	ME2SA4	24500	28000	47200	56000	20100	272
1.7	2750	1.4	816	304L4	—	BN80A4	BE80A4	M1LA4	ME2SA4	24500	28000	47200	56000	20100	284
1.7	2750	2.0	816	305L4	—	BN80A4	BE80A4	M1LA4	ME2SA4	24500	28000	47200	56000	20100	296
1.7	2680	1.3	797	—	305R4	BN80A4	BE80A4	M1LA4	ME2SA4	24400	27900	47100	55800	19900	298
1.7	2770	1.5	824	—	305R4	BN80A4	BE80A4	M1LA4	ME2SA4	24500	28000	47300	56100	20200	298
1.7	2720	2.8	809	306L4	—	BN80A4	BE80A4	M1LA4	ME2SA4	29100	33200	66400	76600	29200	308
1.7	2790	2.3	830	—	306R4	BN80A4	BE80A4	M1LA4	ME2SA4	29200	33300	66600	76900	29500	310
1.9	2420	0.9	718	303L4	—	BN80A4	BE80A4	M1LA4	ME2SA4	24000	27500	46400	55000	19300	272
1.9	2420	1.7	718	305L4	—	BN80A4	BE80A4	M1LA4	ME2SA4	24000	27500	46400	55000	19300	296
2.0	2360	1.1	702	304L4	—	BN80A4	BE80A4	M1LA4	ME2SA4	24000	27400	46200	54800	19100	284
2.0	2350	1.1	699	—	304R4	BN80A4	BE80A4	M1LA4	ME2SA4	24000	27400	46200	54800	19100	286
2.1	2180	1.1	649	303L4	—	BN80A4	BE80A4	M1LA4	ME2SA4	23700	27100	45700	54200	18600	272
2.1	2220	1.0	659	—	303R4	BN80A4	BE80A4	M1LA4	ME2SA4	23800	27100	45800	54300	18700	274
2.1	2180	1.6	649	304L4	—	BN80A4	BE80A4	M1LA4	ME2SA4	23700	27100	45700	54200	18600	284
2.1	2180	2.1	649	305L4	—	BN80A4	BE80A4	M1LA4	ME2SA4	23700	27100	45700	54200	18600	296
2.1	2220	1.9	659	—	305R4	BN80A4	BE80A4	M1LA4	ME2SA4	23800	27100	45800	54300	18700	298
2.1	2240	2.7	665	—	306R4	BN80A4	BE80A4	M1LA4	ME2SA4	28300	32300	64600	74500	27400	310
2.3	2070	1.0	616	301L4	—	BN80A4	BE80A4	M1LA4	ME2SA4	7280	7280	24100	26300	6100	262
2.5	1880	1.1	558	301L4	—	BN80A4	BE80A4	M1LA4	ME2SA4	7180	7180	23700	26000	5900	262
2.5	1870	1.5	556	303L4	—	BN80A4	BE80A4	M1LA4	ME2SA4	23200	26500	44700	53000	17700	272
2.5	1910	1.3	567	—	303R4	BN80A4	BE80A4	M1LA4	ME2SA4	23200	26600	44800	53100	17800	274
2.5	1870	2.0	556	304L4	—	BN80A4	BE80A4	M1LA4	ME2SA4	23200	26500	44700	53000	17700	284
2.5	1880	1.4	560	—	304R4	BN80A4	BE80A4	M1LA4	ME2SA4	23200	26500	44800	53000	17700	286

A

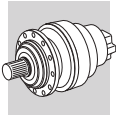

$$P_1 = 0.55 \text{ kW}$$

n ₂ min ⁻¹	M ₂ Nm	S	i	IE1				IE2				Rn ₂ [N]					
				MC	MZ	HC/PC	HZ/PZ	FZ									
2.5	1870	2.9	556	305L4	—	BN80A4	BE80A4	M1LA4	ME2SA4	23200	26500	44700	53000	17700	296		
2.5	1910	2.6	567	—	305R4	BN80A4	BE80A4	M1LA4	ME2SA4	23200	26600	44800	53100	17800	298		
2.6	1780	1.2	528	—	303R4	BN80A4	BE80A4	M1LA4	ME2SA4	23000	26300	44400	52600	17400	274		
2.6	1780	2.2	528	—	305R4	BN80A4	BE80A4	M1LA4	ME2SA4	23000	26300	44400	52600	17400	298		
2.8	1660	1.3	494	301L4	—	BN80A4	BE80A4	M1LA4	ME2SA4	7060	7060	23300	25500	5670	262		
2.8	1660	1.6	492	303L4	—	BN80A4	BE80A4	M1LA4	ME2SA4	22800	26000	43900	52100	17000	272		
2.8	1660	2.3	492	304L4	—	BN80A4	BE80A4	M1LA4	ME2SA4	22800	26000	43900	52100	17000	284		
3.1	1500	1.4	447	301L4	—	BN80A4	BE80A4	M1LA4	ME2SA4	6960	6960	23000	25100	5480	262		
3.1	1520	1.3	453	—	301R4	BN80A4	BE80A4	M1LA4	ME2SA4	6970	6970	23100	25200	5510	264		
3.1	1500	1.9	446	303L4	—	BN80A4	BE80A4	M1LA4	ME2SA4	22500	25700	43300	51300	16400	272		
3.1	1520	1.5	452	—	303R4	BN80A4	BE80A4	M1LA4	ME2SA4	22500	25700	43400	51400	16500	274		
3.1	1500	2.5	446	304L4	—	BN80A4	BE80A4	M1LA4	ME2SA4	22500	25700	43300	51300	16400	284		
3.1	1520	2.4	452	—	304R4	BN80A4	BE80A4	M1LA4	ME2SA4	22500	25700	43400	51400	16500	286		
3.3	1480	1.7	426	304L3	—	BN80A4	BE80A4	M1LA4	ME2SA4	22300	25500	43000	51000	16200	284		
3.4	1360	1.0	403	301L4	—	BN80A4	BE80A4	M1LA4	ME2SA4	6850	6850	22700	24800	5300	262		
3.4	1390	1.7	413	303L4	—	BN80A4	BE80A4	M1LA4	ME2SA4	22200	25400	42900	50800	16000	272		
3.4	1390	2.2	413	304L4	—	BN80A4	BE80A4	M1LA4	ME2SA4	22200	25400	42900	50800	16000	284		
3.4	1390	1.8	414	—	304R4	BN80A4	BE80A4	M1LA4	ME2SA4	22200	25400	42900	50800	16000	286		
3.5	1320	1.0	394	—	301R4	BN80A4	BE80A4	M1LA4	ME2SA4	6830	6830	22600	24700	5250	264		
3.5	1390	1.4	402	303L3	—	BN80A4	BE80A4	M1LA4	ME2SA4	22100	25300	42700	50600	15900	272		
3.5	1390	2.7	402	305L3	—	BN80A4	BE80A4	M1LA4	ME2SA4	22100	25300	42700	50600	15900	296		
3.6	1350	1.3	389	303L3	—	BN80A4	BE80A4	M1LA4	ME2SA4	22000	25200	42500	50400	15700	272		
3.6	1310	1.5	390	—	303R4	BN80A4	BE80A4	M1LA4	ME2SA4	22000	25200	42500	50400	15700	274		
3.6	1350	2.4	389	305L3	—	BN80A4	BE80A4	M1LA4	ME2SA4	22000	25200	42500	50400	15700	296		
3.6	1310	2.9	390	—	305R4	BN80A4	BE80A4	M1LA4	ME2SA4	22000	25200	42500	50400	15700	298		
3.7	1300	1.1	374	301L3	—	BN80A4	BE80A4	M1LA4	ME2SA4	6780	6780	22400	24500	5160	262		
3.8	1220	1.6	363	—	301R4	BN80A4	BE80A4	M1LA4	ME2SA4	6750	6750	22300	24400	5110	264		
3.8	1220	1.9	364	—	303R4	BN80A4	BE80A4	M1LA4	ME2SA4	21800	24900	42100	49900	15400	274		
3.8	1220	2.4	364	—	304R4	BN80A4	BE80A4	M1LA4	ME2SA4	21800	24900	42100	49900	15400	286		
4.1	1130	2.0	336	—	303R4	BN80A4	BE80A4	M1LA4	ME2SA4	21600	24700	41600	49300	14900	274		
4.1	1180	2.1	341	304L3	—	BN80A4	BE80A4	M1LA4	ME2SA4	21600	24700	41700	49400	15000	284		
4.1	1140	2.1	338	—	304R4	BN80A4	BE80A4	M1LA4	ME2SA4	21600	24700	41600	49300	15000	286		
4.2	1110	1.8	330	301L4	—	BN80A4	BE80A4	M1LA4	ME2SA4	6660	6660	22000	24100	4960	262		
4.3	1110	1.7	321	303L3	—	BN80A4	BE80A4	M1LA4	ME2SA4	21400	24500	41300	49000	14700	272		
4.4	1050	1.8	313	—	303R4	BN80A4	BE80A4	M1LA4	ME2SA4	21400	24400	41200	48800	14600	274		
4.6	1040	1.3	299	301L3	—	BN80A4	BE80A4	M1LA4	ME2SA4	6570	6570	21700	23700	4790	262		
4.8	980	1.0	291	—	300R4	BN80A4	BE80A4	M1LA4	ME2SA4	6540	6540	21600	25200	4750	254		
4.8	980	2.0	291	—	301R4	BN80A4	BE80A4	M1LA4	ME2SA4	6540	6540	21600	23700	4750	264		
4.8	980	2.7	290	—	303R4	BN80A4	BE80A4	M1LA4	ME2SA4	21100	24100	40700	48300	14200	274		
5.0	960	2.3	276	303L3	—	BN80A4	BE80A4	M1LA4	ME2SA4	21000	24000	40500	48000	14000	272		
5.1	950	2.5	273	304L3	—	BN80A4	BE80A4	M1LA4	ME2SA4	21000	24000	40500	48000	14000	284		
5.2	900	1.0	268	—	300R4	BN80A4	BE80A4	M1LA4	ME2SA4	6500	6500	21500	25000	4620	254		
5.2	900	2.1	268	—	301R4	BN80A4	BE80A4	M1LA4	ME2SA4	6500	6500	21500	23500	4620	264		
5.4	890	2.1	258	303L3	—	BN80A4	BE80A4	M1LA4	ME2SA4	21000	24000	40500	48000	13700	272		
5.4	860	2.1	255	—	303R4	BN80A4	BE80A4	M1LA4	ME2SA4	21000	24000	40500	48000	13600	274		
5.8	830	1.6	240	301L3	—	BN80A4	BE80A4	M1LA4	ME2SA4	6500	6500	21500	23500	4450	262		
5.9	800	1.6	237	—	301R4	BN80A4	BE80A4	M1LA4	ME2SA4	6500	6500	21500	23500	4440	264		
6.0	780	2.4	231	—	303R4	BN80A4	BE80A4	M1LA4	ME2SA4	21000	24000	40500	48000	13200	274		
6.3	770	1.2	221	300L3	—	BN80A4	BE80A4	M1LA4	ME2SA4	6500	6500	21500	25000	4330	252		
6.3	770	2.3	221	301L3	—	BN80A4	BE80A4	M1LA4	ME2SA4	6500	6500	21500	23500	4330	262		
6.3	760	2.9	220	303L3	—	BN80A4	BE80A4	M1LA4	ME2SA4	21000	24000	40500	48000	13000	272		
6.5	720	1.3	215	—	300R4	BN80A4	BE80A4	M1LA4	ME2SA4	6500	6500	21500	25000	4290	254		
6.5	720	2.5	215	—	301R4	BN80A4	BE80A4	M1LA4	ME2SA4	6500	6500	21500	23500	4290	264		
7.2	670	1.0	192	300L3	—	BN80A4	BE80A4	M1LA4	ME2SA4	6500	6500	21500	25000	4140	252		
7.2	670	2.0	192	301L3	—	BN80A4	BE80A4	M1LA4	ME2SA4	6500	6500	21500	23500	4140	262		
7.3	660	2.8	190	303L3	—	BN80A4	BE80A4	M1LA4	ME2SA4	21000	24000	40500	48000	12400	272		
7.8	610	1.4	177	300L3	—	BN80A4	BE80A4	M1LA4	ME2SA4	6500	6500	21500	25000	4030	252		
7.8	610	2.9	177	301L3	—	BN80A4	BE80A4	M1LA4	ME2SA4	6500	6500	21500	23500	4030	262		
7.9	590	1.5	175	—	300R4	BN80A4	BE80A4	M1LA4	ME2SA4	6500	6500	21500	25000	4010	254		
8.8	530	1.6	159	—	300R4	BN80A4	BE80A4	M1LA4	ME2SA4	6500	6500	21500	25000	3880	254		
9.7	480	1.3	143	—	300R4	BN80A4	BE80A4	M1LA4	ME2SA4	6500	6500	21500	25000	3750	254		
9.7	480	2.7	143	—	301R4	BN80A4	BE80A4	M1LA4	ME2SA4	6500	6500	21500	23500	3750	264		
9.8	490	1.8	142	300L3	—	BN80A4	BE80A4	M1LA4	ME2SA4	6500	6500	21500	25000	3740	252		
10.5	460	1.2	133	—	300R3	BN80A4	BE80A4	M1LA4	ME2SA4	6400	6400	21200	24700	3660	254		
10.5	460	2.5	133	—	301R3	BN80A4	BE80A4	M1LA4	ME2SA4	6400	6400	21200	23200	3660	264		

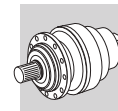

$P_1 = 0.55 \text{ kW}$

n ₂ min ⁻¹	M ₂ Nm	S	i	IE1		IE2		Rn ₂ [N]					FZ	📄	
				IE1	IE2	IE1	IE2	MC	MZ	HC/PC	HZ/PZ				
10.6	450	1.9	131	300L3	—	BN80A4	BE80A4	M1LA4	ME2SA4	6370	6370	21100	24600	3640	252
10.7	440	2.0	130	—	300R4	BN80A4	BE80A4	M1LA4	ME2SA4	6350	6350	21100	24500	3630	254
12.0	400	1.6	116	300L3	—	BN80A4	BE80A4	M1LA4	ME2SA4	6120	6120	20400	23700	3490	252
13.1	370	1.8	106	—	300R3	BN80A4	BE80A4	M1LA4	ME2SA4	5950	5950	19800	23100	3400	254
13.1	360	2.4	106	—	300R4	BN80A4	BE80A4	M1LA4	ME2SA4	5940	5940	19800	23000	3390	254
13.3	360	2.4	105	300L3	—	BN80A4	BE80A4	M1LA4	ME2SA4	5920	5920	19800	23000	3380	252
16.2	300	2.9	85.6	300L3	—	BN80A4	BE80A4	M1LA4	ME2SA4	5530	5530	18600	21600	3160	252
16.3	300	2.2	85.2	—	300R3	BN80A4	BE80A4	M1LA4	ME2SA4	5520	5520	18600	21600	3150	254
19.9	240	2.7	69.9	300L3	—	BN80A4	BE80A4	M1LA4	ME2SA4	5170	5170	17500	20300	2950	252
20.4	240	2.7	68.2	—	300R3	BN80A4	BE80A4	M1LA4	ME2SA4	5130	5130	17400	20200	2930	254
21.5	230	2.4	64.8	300L2	—	BN80A4	BE80A4	M1LA4	ME2SA4	5040	5040	17100	19900	2880	252

$P_1 = 0.75 \text{ kW}$

n ₂ min ⁻¹	M ₂ Nm	S	i	IE2		IE3		Rn ₂ [N]					FZ	📄	
				IE2	IE3	IE2	IE3	MC	MZ	HC/PC	HZ/PZ				
0.57	11200	2.1	2523	310ML4	—	BE80B4	BX80B4	—	—	—	—	106500	135000	65000	344
0.59	10700	1.0	2423	307L4	—	BE80B4	BX80B4	ME2SB4	MX2SB4	40700	50900	91600	120500	45000	320
0.59	10700	1.6	2423	309L4	—	BE80B4	BX80B4	—	—	—	—	93600	120500	36000	334
0.70	9040	1.6	2041	307L4	—	BE80B4	BX80B4	ME2SB4	MX2SB4	39700	49700	89400	117600	45000	320
0.71	8860	1.9	2003	309L4	—	BE80B4	BX80B4	—	—	—	—	91100	117300	36000	334
0.71	8950	2.7	2022	310ML4	—	BE80B4	BX80B4	—	—	—	—	103100	130800	65000	344
0.78	8160	1.2	1843	306L4	—	BE80B4	BX80B4	ME2SB4	MX2SB4	32600	37200	74400	85900	35000	308
0.81	7820	2.0	1767	307L4	—	BE80B4	BX80B4	ME2SB4	MX2SB4	38900	48600	87600	115200	45000	320
0.83	7630	2.2	1723	309L4	—	BE80B4	BX80B4	—	—	—	—	89200	114800	36000	334
0.89	7100	2.4	1605	309L4	—	BE80B4	BX80B4	—	—	—	—	88300	113600	36000	334
0.90	7070	1.2	1597	306L4	—	BE80B4	BX80B4	ME2SB4	MX2SB4	32000	36400	72900	84100	35000	308
0.90	7040	2.1	1591	307L4	—	BE80B4	BX80B4	ME2SB4	MX2SB4	38300	47900	86200	113500	45000	320
0.97	6530	1.5	1475	306L4	—	BE80B4	BX80B4	ME2SB4	MX2SB4	31600	36000	72000	83200	35000	308
1.0	6230	2.5	1408	307L4	—	BE80B4	BX80B4	ME2SB4	MX2SB4	37700	47100	84800	111500	44800	320
1.0	6110	2.8	1380	309L4	—	BE80B4	BX80B4	—	—	—	—	86400	111200	35600	334
1.1	5660	1.0	1278	305L4	—	BE80B4	BX80B4	ME2SB4	MX2SB4	26000	29700	50200	59400	23100	296
1.1	5660	1.5	1279	306L4	—	BE80B4	BX80B4	ME2SB4	MX2SB4	31000	35300	70600	81500	33700	308
1.1	5640	2.2	1274	307L4	—	BE80B4	BX80B4	ME2SB4	MX2SB4	37100	46400	83600	109900	43300	320
1.1	5690	2.9	1286	309L4	—	BE80B4	BX80B4	—	—	—	—	85500	110100	34700	334
1.2	5120	2.8	1157	307L4	—	BE80B4	BX80B4	ME2SB4	MX2SB4	36600	45800	82400	108400	41900	320
1.3	4860	0.9	1098	305L4	—	BE80B4	BX80B4	ME2SB4	MX2SB4	25400	29100	49100	58200	22000	296
1.3	4840	1.6	1095	306L4	—	BE80B4	BX80B4	ME2SB4	MX2SB4	30300	34500	69000	79700	32000	308
1.4	4510	1.2	1018	305L4	—	BE80B4	BX80B4	ME2SB4	MX2SB4	25200	28800	48600	57500	21400	296
1.4	4490	2.1	1015	306L4	—	BE80B4	BX80B4	ME2SB4	MX2SB4	30000	34200	68300	78900	31200	308
1.6	3970	1.1	896	305L4	—	BE80B4	BX80B4	ME2SB4	MX2SB4	24700	28300	47700	56500	20500	296
1.6	3880	2.0	877	306L4	—	BE80B4	BX80B4	ME2SB4	MX2SB4	29300	33400	66900	77200	29700	308
1.7	3650	1.2	824	—	305R4	BE80B4	BX80B4	ME2SB4	MX2SB4	24400	27900	47100	55800	20000	298
1.7	3680	1.7	830	—	306R4	BE80B4	BX80B4	ME2SB4	MX2SB4	29100	33200	66400	76600	29200	310
1.8	3610	1.1	816	304L4	—	BE80B4	BX80B4	ME2SB4	MX2SB4	24400	27900	47000	55800	19900	284
1.8	3610	1.5	816	305L4	—	BE80B4	BX80B4	ME2SB4	MX2SB4	24400	27900	47000	55800	19900	296
1.8	3530	1.0	797	—	305R4	BE80B4	BX80B4	ME2SB4	MX2SB4	24300	27800	46900	55600	19800	298
1.8	3580	2.2	809	306L4	—	BE80B4	BX80B4	ME2SB4	MX2SB4	29000	33100	66100	76300	28900	308
2.0	3180	1.3	718	305L4	—	BE80B4	BX80B4	ME2SB4	MX2SB4	24000	27400	46200	54700	19100	296
2.1	2940	2.1	665	—	306R4	BE80B4	BX80B4	ME2SB4	MX2SB4	28200	32200	64300	74200	27100	310
2.2	2870	1.2	649	304L4	—	BE80B4	BX80B4	ME2SB4	MX2SB4	23600	27000	45500	54000	18400	284
2.2	2870	1.6	649	305L4	—	BE80B4	BX80B4	ME2SB4	MX2SB4	23600	27000	45500	54000	18400	296
2.2	2920	1.4	659	—	305R4	BE80B4	BX80B4	ME2SB4	MX2SB4	23700	27000	45600	54100	18500	298
2.5	2510	1.0	567	—	303R4	BE80B4	BX80B4	ME2SB4	MX2SB4	23200	26500	44700	52900	17600	274
2.5	2510	2.0	567	—	305R4	BE80B4	BX80B4	ME2SB4	MX2SB4	23200	26500	44700	52900	17600	298
2.6	2460	1.1	556	303L4	—	BE80B4	BX80B4	ME2SB4	MX2SB4	23100	26400	44500	52800	17500	272
2.6	2460	1.5	556	304L4	—	BE80B4	BX80B4	ME2SB4	MX2SB4	23100	26400	44500	52800	17500	284
2.6	2480	1.0	560	—	304R4	BE80B4	BX80B4	ME2SB4	MX2SB4	23100	26400	44600	52800	17600	286
2.6	2460	2.2	556	305L4	—	BE80B4	BX80B4	ME2SB4	MX2SB4	23100	26400	44500	52800	17500	296
2.7	2340	1.7	528	—	305R4	BE80B4	BX80B4	ME2SB4	MX2SB4	22900	26200	44200	52400	17200	298
2.9	2190	1.0	494	301L4	—	BE80B4	BX80B4	ME2SB4	MX2SB4	7030	7030	23200	25400	5610	262
2.9	2180	1.2	492	303L4	—	BE80B4	BX80B4	ME2SB4	MX2SB4	22700	25900	43800	51900	16800	272

A

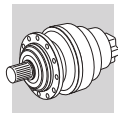

$P_1 = 0.75 \text{ kW}$

n_2 min ⁻¹	M_2 Nm	S	i			IE2		IE3		Rn ₂ [N]					
						IE2	IE3	IE2	IE3	MC	MZ	HC/PC	HZ/PZ	FZ	
2.9	2180	1.7	492	304L4	—	BE80B4	BX80B4	ME2SB4	MX2SB4	22700	25900	43800	51900	16800	284
2.9	2180	2.5	492	305L4	—	BE80B4	BX80B4	ME2SB4	MX2SB4	22700	25900	43800	51900	16800	296
3.2	1980	1.0	447	301L4	—	BE80B4	BX80B4	ME2SB4	MX2SB4	6930	6930	22900	25000	5430	262
3.2	2010	1.0	453	—	301R4	BE80B4	BX80B4	ME2SB4	MX2SB4	6940	6940	23000	25100	5450	264
3.2	1970	1.4	446	303L4	—	BE80B4	BX80B4	ME2SB4	MX2SB4	22400	25600	43100	51100	16300	272
3.2	2000	1.1	452	—	303R4	BE80B4	BX80B4	ME2SB4	MX2SB4	22400	25600	43200	51200	16300	274
3.2	1970	1.9	446	304L4	—	BE80B4	BX80B4	ME2SB4	MX2SB4	22400	25600	43100	51100	16300	284
3.2	2000	1.8	452	—	304R4	BE80B4	BX80B4	ME2SB4	MX2SB4	22400	25600	43200	51200	16300	286
3.2	1970	2.8	446	305L4	—	BE80B4	BX80B4	ME2SB4	MX2SB4	22400	25600	43100	51100	16300	296
3.2	2000	2.4	452	—	305R4	BE80B4	BX80B4	ME2SB4	MX2SB4	22400	25600	43200	51200	16300	298
3.4	1940	1.3	426	304L3	—	BE80B4	BX80B4	ME2SB4	MX2SB4	22200	25400	42900	50800	16000	284
3.5	1830	1.3	413	303L4	—	BE80B4	BX80B4	ME2SB4	MX2SB4	22100	25300	42700	50600	15900	272
3.5	1830	1.7	413	304L4	—	BE80B4	BX80B4	ME2SB4	MX2SB4	22100	25300	42700	50600	15900	284
3.5	1830	1.4	414	—	304R4	BE80B4	BX80B4	ME2SB4	MX2SB4	22100	25300	42700	50600	15900	286
3.5	1830	2.6	413	305L4	—	BE80B4	BX80B4	ME2SB4	MX2SB4	22100	25300	42700	50600	15900	296
3.6	1830	1.1	402	303L3	—	BE80B4	BX80B4	ME2SB4	MX2SB4	22000	25200	42500	50400	15700	272
3.6	1830	2.1	402	305L3	—	BE80B4	BX80B4	ME2SB4	MX2SB4	22000	25200	42500	50400	15700	296
3.7	1770	1.0	389	303L3	—	BE80B4	BX80B4	ME2SB4	MX2SB4	21900	25100	42300	50200	15500	272
3.7	1730	1.1	390	—	303R4	BE80B4	BX80B4	ME2SB4	MX2SB4	22000	25100	42300	50200	15600	274
3.7	1770	1.8	389	305L3	—	BE80B4	BX80B4	ME2SB4	MX2SB4	21900	25100	42300	50200	15500	296
3.7	1730	2.2	390	—	305R4	BE80B4	BX80B4	ME2SB4	MX2SB4	22000	25100	42300	50200	15600	298
3.9	1610	1.2	363	—	301R4	BE80B4	BX80B4	ME2SB4	MX2SB4	6730	6730	22200	24300	5070	264
3.9	1610	1.4	364	—	303R4	BE80B4	BX80B4	ME2SB4	MX2SB4	21700	24800	41900	49700	15200	274
3.9	1610	1.8	364	—	304R4	BE80B4	BX80B4	ME2SB4	MX2SB4	21700	24800	41900	49700	15200	286
3.9	1610	2.9	364	—	305R4	BE80B4	BX80B4	ME2SB4	MX2SB4	21700	24800	41900	49700	15200	298
4.2	1560	1.6	341	304L3	—	BE80B4	BX80B4	ME2SB4	MX2SB4	21500	24600	41500	49200	14900	284
4.2	1490	1.6	338	—	304R4	BE80B4	BX80B4	ME2SB4	MX2SB4	21500	24600	41500	49100	14800	286
4.3	1460	1.3	330	301L4	—	BE80B4	BX80B4	ME2SB4	MX2SB4	6640	6640	21900	24000	4910	262
4.3	1490	1.5	336	—	303R4	BE80B4	BX80B4	ME2SB4	MX2SB4	21500	24600	41400	49100	14800	274
4.4	1470	1.3	321	303L3	—	BE80B4	BX80B4	ME2SB4	MX2SB4	21400	24400	41200	48800	14600	272
4.4	1470	2.5	321	305L3	—	BE80B4	BX80B4	ME2SB4	MX2SB4	21400	24400	41200	48800	14600	296
4.6	1380	1.4	313	—	303R4	BE80B4	BX80B4	ME2SB4	MX2SB4	21300	24300	41000	48600	14500	274
4.6	1380	2.6	313	—	305R4	BE80B4	BX80B4	ME2SB4	MX2SB4	21300	24300	41000	48600	14500	298
4.7	1360	2.6	307	—	304R4	BE80B4	BX80B4	ME2SB4	MX2SB4	21200	24200	40900	48500	14400	286
4.8	1360	1.0	299	301L3	—	BE80B4	BX80B4	ME2SB4	MX2SB4	6540	6540	21600	23700	4750	262
4.9	1290	1.5	291	—	301R4	BE80B4	BX80B4	ME2SB4	MX2SB4	6520	6520	21600	23600	4700	264
4.9	1280	2.1	290	—	303R4	BE80B4	BX80B4	ME2SB4	MX2SB4	21000	24000	40600	48100	14100	274
4.9	1280	2.9	290	—	304R4	BE80B4	BX80B4	ME2SB4	MX2SB4	21000	24000	40600	48100	14100	286
5.2	1260	1.8	276	303L3	—	BE80B4	BX80B4	ME2SB4	MX2SB4	21000	24000	40500	48000	13900	272
5.2	1250	1.9	273	304L3	—	BE80B4	BX80B4	ME2SB4	MX2SB4	21000	24000	40500	48000	13800	284
5.3	1190	1.6	268	—	301R4	BE80B4	BX80B4	ME2SB4	MX2SB4	6500	6500	21500	23500	4580	264
5.6	1180	1.6	258	303L3	—	BE80B4	BX80B4	ME2SB4	MX2SB4	21000	24000	40500	48000	13600	272
5.6	1130	1.6	255	—	303R4	BE80B4	BX80B4	ME2SB4	MX2SB4	21000	24000	40500	48000	13500	274
6.0	1090	1.2	240	301L3	—	BE80B4	BX80B4	ME2SB4	MX2SB4	6500	6500	21500	23500	4410	262
6.0	1050	1.2	237	—	301R4	BE80B4	BX80B4	ME2SB4	MX2SB4	6500	6500	21500	23500	4400	264
6.2	1020	1.8	231	—	303R4	BE80B4	BX80B4	ME2SB4	MX2SB4	21000	24000	40500	48000	13100	274
6.5	1010	0.9	221	300L3	—	BE80B4	BX80B4	ME2SB4	MX2SB4	6500	6500	21500	25000	4290	252
6.5	1010	1.8	221	301L3	—	BE80B4	BX80B4	ME2SB4	MX2SB4	6500	6500	21500	23500	4290	262
6.5	1010	2.2	220	303L3	—	BE80B4	BX80B4	ME2SB4	MX2SB4	21000	24000	40500	48000	12900	272
6.7	950	1.0	215	—	300R4	BE80B4	BX80B4	ME2SB4	MX2SB4	6500	6500	21500	25000	4250	254
6.7	950	1.9	215	—	301R4	BE80B4	BX80B4	ME2SB4	MX2SB4	6500	6500	21500	23500	4250	264
6.7	950	2.9	214	—	303R4	BE80B4	BX80B4	ME2SB4	MX2SB4	21000	24000	40500	48000	12700	274
7.1	920	2.6	202	304L3	—	BE80B4	BX80B4	ME2SB4	MX2SB4	21000	24000	40500	48000	12500	284
7.4	880	1.5	192	301L3	—	BE80B4	BX80B4	ME2SB4	MX2SB4	6500	6500	21500	23500	4100	262
7.5	870	2.1	190	303L3	—	BE80B4	BX80B4	ME2SB4	MX2SB4	21000	24000	40500	48000	12300	272
7.7	820	2.8	185	—	303R4	BE80B4	BX80B4	ME2SB4	MX2SB4	21000	24000	40500	48000	12100	274
8.1	810	1.1	177	300L3	—	BE80B4	BX80B4	ME2SB4	MX2SB4	6500	6500	21500	25000	3990	252
8.1	780	1.1	175	—	300R4	BE80B4	BX80B4	ME2SB4	MX2SB4	6500	6500	21500	25000	3980	254
8.1	810	2.2	177	301L3	—	BE80B4	BX80B4	ME2SB4	MX2SB4	6500	6500	21500	23500	3990	262
8.1	780	2.3	175	—	301R4	BE80B4	BX80B4	ME2SB4	MX2SB4	6500	6500	21500	23500	3980	264
8.1	810	2.7	178	303L3	—	BE80B4	BX80B4	ME2SB4	MX2SB4	21000	24000	40500	48000	12000	272
8.7	750	3.0	164	303L3	—	BE80B4	BX80B4	ME2SB4	MX2SB4	21000	24000	40500	48000	11700	272
9.0	700	1.2	159	—	300R4	BE80B4	BX80B4	ME2SB4	MX2SB4	6500	6500	21500	25000	3850	254
9.0	700	2.5	159	—	301R4	BE80B4	BX80B4	ME2SB4	MX2SB4	6500	6500	21500	23500	3850	264
9.4	700	2.6	152	303L3	—	BE80B4	BX80B4	ME2SB4	MX2SB4	21000	24000	40500	48000	11400	272

A

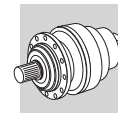

A

$P_1 = 0.75 \text{ kW}$



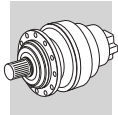

n_2 min ⁻¹	M_2 Nm	S	i							R _{n2} [N]					
						IE2	IE3	IE2	IE3	MC	MZ	HC/PC	HZ/PZ	FZ	
10.0	630	1.0	143	—	300R4	BE80B4	BX80B4	ME2SB4	MX2SB4	6500	6500	21500	25000	3720	254
10.0	630	2.1	143	—	301R4	BE80B4	BX80B4	ME2SB4	MX2SB4	6500	6500	21500	23500	3720	264
10.1	650	1.3	142	300L3	—	BE80B4	BX80B4	ME2SB4	MX2SB4	6480	6480	21500	24900	3700	252
10.1	650	2.7	142	301L3	—	BE80B4	BX80B4	ME2SB4	MX2SB4	6480	6480	21500	23400	3700	262
10.8	610	0.9	133	—	300R3	BE80B4	BX80B4	ME2SB4	MX2SB4	6340	6340	21000	24500	3620	254
10.8	610	1.9	133	—	301R3	BE80B4	BX80B4	ME2SB4	MX2SB4	6340	6340	21000	23000	3620	264
10.9	600	1.4	131	300L3	—	BE80B4	BX80B4	ME2SB4	MX2SB4	6310	6310	20900	24300	3610	252
10.9	600	2.9	131	301L3	—	BE80B4	BX80B4	ME2SB4	MX2SB4	6310	6310	20900	22900	3610	262
11.0	570	1.5	130	—	300R4	BE80B4	BX80B4	ME2SB4	MX2SB4	6290	6290	20900	24300	3590	254
11.0	570	3.0	130	—	301R4	BE80B4	BX80B4	ME2SB4	MX2SB4	6290	6290	20900	22800	3590	264
12.3	530	1.2	116	300L3	—	BE80B4	BX80B4	ME2SB4	MX2SB4	6060	6060	20200	23500	3460	252
12.3	530	2.5	116	301L3	—	BE80B4	BX80B4	ME2SB4	MX2SB4	6060	6060	20200	22100	3460	262
13.4	490	1.3	106	—	300R3	BE80B4	BX80B4	ME2SB4	MX2SB4	5890	5890	19700	22900	3370	254
13.4	490	2.7	106	—	301R3	BE80B4	BX80B4	ME2SB4	MX2SB4	5890	5890	19700	21500	3370	264
13.5	470	1.8	106	—	300R4	BE80B4	BX80B4	ME2SB4	MX2SB4	5880	5880	19600	22800	3360	254
13.6	480	1.8	105	300L3	—	BE80B4	BX80B4	ME2SB4	MX2SB4	5860	5860	19600	22800	3350	252
16.7	390	2.2	85.6	300L3	—	BE80B4	BX80B4	ME2SB4	MX2SB4	5480	5480	18400	21400	3130	252
16.8	390	1.7	85.2	—	300R3	BE80B4	BX80B4	ME2SB4	MX2SB4	5470	5470	18400	21400	3120	254
18.2	360	2.4	78.7	—	300R3	BE80B4	BX80B4	ME2SB4	MX2SB4	5330	5330	18000	20900	3040	254
18.5	350	2.4	77.5	300L3	—	BE80B4	BX80B4	ME2SB4	MX2SB4	5300	5300	17900	20800	3030	252
20.5	320	2.0	69.9	300L3	—	BE80B4	BX80B4	ME2SB4	MX2SB4	5120	5120	17300	20200	2920	252
21.0	310	2.1	68.2	—	300R3	BE80B4	BX80B4	ME2SB4	MX2SB4	5080	5080	17200	20000	2900	254
22.1	300	1.8	64.8	300L2	—	BE80B4	BX80B4	ME2SB4	MX2SB4	4990	4990	17000	19700	2850	252
22.6	290	2.9	63.2	300L3	—	BE80B4	BX80B4	ME2SB4	MX2SB4	4950	4950	16800	19600	2830	252
22.7	290	3.0	62.9	—	300R3	BE80B4	BX80B4	ME2SB4	MX2SB4	4940	4940	16800	19500	2820	254
27.5	240	2.7	51.9	300L2	—	BE80B4	BX80B4	ME2SB4	MX2SB4	4640	4640	15900	18400	2650	252

$P_1 = 1.1 \text{ kW}$

n_2 min ⁻¹	M_2 Nm	S	i							R _{n2} [N]					
						IE2	IE3	IE2	IE3	MC	MZ	HC/PC	HZ/PZ	FZ	
0.57	16500	1.4	2523	310ML4	—	BE90S4	BX90S4	—	—	—	—	106500	135000	65000	344
0.59	15900	1.1	2423	309L4	—	BE90S4	BX90S4	—	—	—	—	93600	120500	36000	334
0.65	14300	2.8	2187	313ML4	—	BE90S4	BX90S4	—	—	—	—	189900	222500	80000	368
0.68	13700	2.7	2096	311ML4	—	BE90S4	BX90S4	—	—	—	—	130300	132900	65000	356
0.70	13400	1.1	2041	307L4	—	BE90S4	BX90S4	ME3SA4	MX3SA4	39700	49700	89400	117600	45000	320
0.71	13100	1.3	2003	309L4	—	BE90S4	BX90S4	—	—	—	—	91100	117300	36000	334
0.71	13200	1.8	2022	310ML4	—	BE90S4	BX90S4	—	—	—	—	103100	130800	65000	344
0.80	11800	2.0	1794	310ML4	—	BE90S4	BX90S4	—	—	—	—	101400	128600	65000	344
0.81	11600	1.4	1767	307L4	—	BE90S4	BX90S4	ME3SA4	MX3SA4	38900	48600	87600	115200	45000	320
0.83	11300	1.5	1723	309L4	—	BE90S4	BX90S4	—	—	—	—	89200	114800	36000	334
0.86	11000	2.2	1672	310ML4	—	BE90S4	BX90S4	—	—	—	—	100400	127300	65000	344
0.89	10500	1.6	1605	309L4	—	BE90S4	BX90S4	—	—	—	—	88300	113600	36000	334
0.90	10400	1.4	1591	307L4	—	BE90S4	BX90S4	ME3SA4	MX3SA4	38300	47900	86200	113500	45000	320
0.97	9660	1.0	1475	306L4	—	BE90S4	BX90S4	ME3SA4	MX3SA4	31600	36000	72000	83200	35000	308
0.99	9420	2.5	1438	310ML4	—	BE90S4	BX90S4	—	—	—	—	98200	124600	65000	344
1.0	9230	1.7	1408	307L4	—	BE90S4	BX90S4	ME3SA4	MX3SA4	37700	47100	84800	111500	44800	320
1.0	9040	1.9	1380	309L4	—	BE90S4	BX90S4	—	—	—	—	86400	111200	35600	334
1.1	8380	1.0	1279	306L4	—	BE90S4	BX90S4	ME3SA4	MX3SA4	31000	35300	70600	81500	33700	308
1.1	8350	1.5	1274	307L4	—	BE90S4	BX90S4	ME3SA4	MX3SA4	37100	46400	83600	109900	43300	320
1.1	8420	2.0	1286	309L4	—	BE90S4	BX90S4	—	—	—	—	85500	110100	34700	334
1.2	7580	1.9	1157	307L4	—	BE90S4	BX90S4	ME3SA4	MX3SA4	36600	45800	82400	108400	41900	320
1.2	7530	2.2	1149	309L4	—	BE90S4	BX90S4	—	—	—	—	84200	108300	33500	334
1.3	7170	1.1	1095	306L4	—	BE90S4	BX90S4	ME3SA4	MX3SA4	30300	34500	69000	79700	32000	308
1.4	6650	1.4	1015	306L4	—	BE90S4	BX90S4	ME3SA4	MX3SA4	30000	34200	68300	78900	31200	308
1.4	6550	2.1	999	307L4	—	BE90S4	BX90S4	ME3SA4	MX3SA4	35900	44800	80700	106200	39900	320
1.4	6550	2.8	999	309L4	—	BE90S4	BX90S4	—	—	—	—	82500	106200	31900	334
1.6	5750	1.3	877	306L4	—	BE90S4	BX90S4	ME3SA4	MX3SA4	29300	33400	66900	77200	29700	308
1.6	5940	2.6	906	307L4	—	BE90S4	BX90S4	ME3SA4	MX3SA4	35400	44200	79600	104700	38700	320
1.7	5440	1.2	830	—	306R4	BE90S4	BX90S4	ME3SA4	MX3SA4	29100	33200	66400	76600	29200	310
1.8	5350	1.0	816	305L4	—	BE90S4	BX90S4	ME3SA4	MX3SA4	24400	27900	47000	55800	19900	296
1.8	5300	1.5	809	306L4	—	BE90S4	BX90S4	ME3SA4	MX3SA4	29000	33100	66100	76300	28900	308



$P_1 = 1.1 \text{ kW}$

n_2 min ⁻¹	M_2 Nm	S	i							R _{n2} [N]					
						IE2	IE3	IE2	IE3	MC	MZ	HC/PC	HZ/PZ	FZ	
1.8	5240	2.6	801	307L4	—	BE90S4	BX90S4	ME3SA4	MX3SA4	34800	43400	78200	102900	37100	320
2.0	4580	2.1	700	306L4	—	BE90S4	BX90S4	ME3SA4	MX3SA4	28400	32400	64800	74800	27600	308
2.1	4360	1.4	665	—	306R4	BE90S4	BX90S4	ME3SA4	MX3SA4	28200	32200	64300	74200	27100	310
2.1	4520	2.2	690	—	307R4	BE90S4	BX90S4	—	—	34000	42500	76500	100700	35300	322
2.2	4250	1.1	649	305L4	—	BE90S4	BX90S4	ME3SA4	MX3SA4	23600	27000	45500	54000	18400	296
2.2	4320	0.9	659	—	305R4	BE90S4	BX90S4	ME3SA4	MX3SA4	23700	27000	45600	54100	18500	298
2.3	4160	2.3	636	306L4	—	BE90S4	BX90S4	ME3SA4	MX3SA4	28000	31900	63900	73800	26700	308
2.4	3860	2.4	589	306L4	—	BE90S4	BX90S4	ME3SA4	MX3SA4	27700	31600	63200	73000	26000	308
2.4	3870	2.2	590	—	306R4	BE90S4	BX90S4	ME3SA4	MX3SA4	27700	31600	63200	73000	26100	310
2.5	3710	1.3	567	—	305R4	BE90S4	BX90S4	ME3SA4	MX3SA4	23200	26500	44700	52900	17600	298
2.6	3640	1.0	556	304L4	—	BE90S4	BX90S4	ME3SA4	MX3SA4	23100	26400	44500	52800	17500	284
2.6	3640	1.5	556	305L4	—	BE90S4	BX90S4	ME3SA4	MX3SA4	23100	26400	44500	52800	17500	296
2.6	3600	2.0	550	—	306R4	BE90S4	BX90S4	ME3SA4	MX3SA4	27400	31300	62600	72200	25500	310
2.7	3460	1.1	528	—	305R4	BE90S4	BX90S4	ME3SA4	MX3SA4	22900	26200	44200	52400	17200	298
2.8	3340	2.8	509	306L4	—	BE90S4	BX90S4	ME3SA4	MX3SA4	27100	30900	61900	71500	24800	308
2.9	3220	1.2	492	304L4	—	BE90S4	BX90S4	ME3SA4	MX3SA4	22700	25900	43800	51900	16800	284
2.9	3220	1.7	492	305L4	—	BE90S4	BX90S4	ME3SA4	MX3SA4	22700	25900	43800	51900	16800	296
2.9	3200	2.8	488	—	306R4	BE90S4	BX90S4	ME3SA4	MX3SA4	27000	30800	61500	71000	24500	310
2.9	3210	2.9	490	—	307R4	BE90S4	BX90S4	—	—	32400	40500	72900	95900	31500	322
3.1	2980	2.4	455	—	306R4	BE90S4	BX90S4	ME3SA4	MX3SA4	26700	30500	60900	70300	23900	310
3.2	2920	1.0	446	303L4	—	BE90S4	BX90S4	ME3SA4	MX3SA4	22400	25600	43100	51100	16300	272
3.2	2920	1.3	446	304L4	—	BE90S4	BX90S4	ME3SA4	MX3SA4	22400	25600	43100	51100	16300	284
3.2	2960	1.2	452	—	304R4	BE90S4	BX90S4	ME3SA4	MX3SA4	22400	25600	43200	51200	16300	286
3.2	2920	1.9	446	305L4	—	BE90S4	BX90S4	ME3SA4	MX3SA4	22400	25600	43100	51100	16300	296
3.2	2960	1.6	452	—	305R4	BE90S4	BX90S4	ME3SA4	MX3SA4	22400	25600	43200	51200	16300	298
3.5	2710	1.1	413	304L4	—	BE90S4	BX90S4	ME3SA4	MX3SA4	22100	25300	42700	50600	15900	284
3.5	2710	0.9	414	—	304R4	BE90S4	BX90S4	ME3SA4	MX3SA4	22100	25300	42700	50600	15900	286
3.5	2710	1.8	413	305L4	—	BE90S4	BX90S4	ME3SA4	MX3SA4	22100	25300	42700	50600	15900	296
3.5	2740	2.1	405	306L3	—	BE90S4	BX90S4	ME3SA4	MX3SA4	26300	30000	59900	69200	23000	308
3.6	2710	1.4	402	305L3	—	BE90S4	BX90S4	ME3SA4	MX3SA4	22000	25200	42500	50400	15700	296
3.7	2630	1.2	389	305L3	—	BE90S4	BX90S4	ME3SA4	MX3SA4	21900	25100	42300	50200	15500	296
3.7	2560	1.5	390	—	305R4	BE90S4	BX90S4	ME3SA4	MX3SA4	22000	25100	42300	50200	15600	298
3.7	2560	2.7	391	306L4	—	BE90S4	BX90S4	ME3SA4	MX3SA4	26100	29800	59600	68800	22700	308
3.7	2550	3.0	389	—	306R4	BE90S4	BX90S4	ME3SA4	MX3SA4	26100	29800	59600	68800	22700	310
3.9	2380	1.0	364	—	303R4	BE90S4	BX90S4	ME3SA4	MX3SA4	21700	24800	41900	49700	15200	274
3.9	2380	1.2	364	—	304R4	BE90S4	BX90S4	ME3SA4	MX3SA4	21700	24800	41900	49700	15200	286
3.9	2380	2.0	364	—	305R4	BE90S4	BX90S4	ME3SA4	MX3SA4	21700	24800	41900	49700	15200	298
4.2	2300	1.1	341	304L3	—	BE90S4	BX90S4	ME3SA4	MX3SA4	21500	24600	41500	49200	14900	284
4.2	2210	1.1	338	—	304R4	BE90S4	BX90S4	ME3SA4	MX3SA4	21500	24600	41500	49100	14800	286
4.3	2200	1.0	336	—	303R4	BE90S4	BX90S4	ME3SA4	MX3SA4	21500	24600	41400	49100	14800	274
4.3	2200	2.1	336	—	305R4	BE90S4	BX90S4	ME3SA4	MX3SA4	21500	24600	41400	49100	14800	298
4.4	2170	1.7	321	305L3	—	BE90S4	BX90S4	ME3SA4	MX3SA4	21400	24400	41200	48800	14600	296
4.4	2190	2.5	325	306L3	—	BE90S4	BX90S4	ME3SA4	MX3SA4	25500	29000	58000	67000	21300	308
4.6	2050	0.9	313	—	303R4	BE90S4	BX90S4	ME3SA4	MX3SA4	21300	24300	41000	48600	14500	274
4.6	2050	1.8	313	—	305R4	BE90S4	BX90S4	ME3SA4	MX3SA4	21300	24300	41000	48600	14500	298
4.7	2010	1.7	307	—	304R4	BE90S4	BX90S4	ME3SA4	MX3SA4	21200	24200	40900	48500	14400	286
4.9	1910	1.0	291	—	301R4	BE90S4	BX90S4	ME3SA4	MX3SA4	6520	6520	21600	23600	4700	264
4.9	1900	1.4	290	—	303R4	BE90S4	BX90S4	ME3SA4	MX3SA4	21000	24000	40600	48100	14100	274
4.9	1900	1.9	290	—	304R4	BE90S4	BX90S4	ME3SA4	MX3SA4	21000	24000	40600	48100	14100	286
4.9	1900	2.8	290	—	305R4	BE90S4	BX90S4	ME3SA4	MX3SA4	21000	24000	40600	48100	14100	298
5.0	1950	2.8	288	306L3	—	BE90S4	BX90S4	ME3SA4	MX3SA4	25000	28500	57100	65900	20500	308
5.2	1870	1.2	276	303L3	—	BE90S4	BX90S4	ME3SA4	MX3SA4	21000	24000	40500	48000	13900	272
5.2	1840	1.3	273	304L3	—	BE90S4	BX90S4	ME3SA4	MX3SA4	21000	24000	40500	48000	13800	284
5.2	1870	2.4	276	305L3	—	BE90S4	BX90S4	ME3SA4	MX3SA4	21000	24000	40500	48000	13900	296
5.3	1760	1.1	268	—	301R4	BE90S4	BX90S4	ME3SA4	MX3SA4	6500	6500	21500	23500	4580	264
5.3	1750	2.1	267	—	304R4	BE90S4	BX90S4	ME3SA4	MX3SA4	21000	24000	40500	48000	13700	286
5.6	1740	1.1	258	303L3	—	BE90S4	BX90S4	ME3SA4	MX3SA4	21000	24000	40500	48000	13600	272
5.6	1670	1.1	255	—	303R4	BE90S4	BX90S4	ME3SA4	MX3SA4	21000	24000	40500	48000	13500	274
5.6	1740	2.1	258	305L3	—	BE90S4	BX90S4	ME3SA4	MX3SA4	21000	24000	40500	48000	13600	296
5.6	1670	2.2	255	—	305R4	BE90S4	BX90S4	ME3SA4	MX3SA4	21000	24000	40500	48000	13500	298
6.2	1510	1.2	231	—	303R4	BE90S4	BX90S4	ME3SA4	MX3SA4	21000	24000	40500	48000	13100	274
6.2	1510	2.4	231	—	305R4	BE90S4	BX90S4	ME3SA4	MX3SA4	21000	24000	40500	48000	13100	298
6.3	1480	2.3	227	—	304R4	BE90S4	BX90S4	ME3SA4	MX3SA4	21000	24000	40500	48000	13000	286
6.5	1490	1.2	221	301L3	—	BE90S4	BX90S4	ME3SA4	MX3SA4	6500	6500	21500	23500	4290	262
6.5	1490	1.5	220	303L3	—	BE90S4	BX90S4	ME3SA4	MX3SA4	21000	24000	40500	48000	12900	272

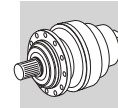

$P_1 = 1.1 \text{ kW}$

n ₂ min ⁻¹	M ₂ Nm	S	i	IE2		IE3		IE2		IE3		Rn ₂ [N]					📄
				MC	MZ	HC/PC	HZ/PZ	FZ									
6.5	1490	2.4	220	304L3	—	BE90S4	BX90S4	ME3SA4	MX3SA4	21000	24000	40500	48000	12900	284		
6.7	1410	1.3	215	—	301R4	BE90S4	BX90S4	ME3SA4	MX3SA4	6500	6500	21500	23500	4250	264		
6.7	1400	2.0	214	—	303R4	BE90S4	BX90S4	ME3SA4	MX3SA4	21000	24000	40500	48000	12700	274		
6.7	1400	2.6	214	—	304R4	BE90S4	BX90S4	ME3SA4	MX3SA4	21000	24000	40500	48000	12700	286		
7.1	1360	1.8	202	304L3	—	BE90S4	BX90S4	ME3SA4	MX3SA4	21000	24000	40500	48000	12500	284		
7.4	1300	1.0	192	301L3	—	BE90S4	BX90S4	ME3SA4	MX3SA4	6500	6500	21500	23500	4100	262		
7.5	1290	1.4	190	303L3	—	BE90S4	BX90S4	ME3SA4	MX3SA4	21000	24000	40500	48000	12300	272		
7.5	1290	2.8	190	305L3	—	BE90S4	BX90S4	ME3SA4	MX3SA4	21000	24000	40500	48000	12300	296		
7.7	1210	1.9	185	—	303R4	BE90S4	BX90S4	ME3SA4	MX3SA4	21000	24000	40500	48000	12100	274		
7.7	1210	2.9	185	—	304R4	BE90S4	BX90S4	ME3SA4	MX3SA4	21000	24000	40500	48000	12100	286		
8.1	1200	1.5	177	301L3	—	BE90S4	BX90S4	ME3SA4	MX3SA4	6500	6500	21500	23500	3990	262		
8.1	1150	1.5	175	—	301R4	BE90S4	BX90S4	ME3SA4	MX3SA4	6500	6500	21500	23500	3980	264		
8.1	1200	1.8	178	303L3	—	BE90S4	BX90S4	ME3SA4	MX3SA4	21000	24000	40500	48000	12000	272		
8.1	1200	2.4	178	304L3	—	BE90S4	BX90S4	ME3SA4	MX3SA4	21000	24000	40500	48000	12000	284		
8.7	1110	2.0	164	303L3	—	BE90S4	BX90S4	ME3SA4	MX3SA4	21000	24000	40500	48000	11700	272		
8.7	1110	2.1	165	304L3	—	BE90S4	BX90S4	ME3SA4	MX3SA4	21000	24000	40500	48000	11700	284		
9.0	1040	1.7	159	—	301R4	BE90S4	BX90S4	ME3SA4	MX3SA4	6500	6500	21500	23500	3850	264		
9.0	1040	2.6	158	—	303R4	BE90S4	BX90S4	ME3SA4	MX3SA4	21000	24000	40500	48000	11500	274		
9.4	1030	1.8	152	303L3	—	BE90S4	BX90S4	ME3SA4	MX3SA4	21000	24000	40500	48000	11400	272		
9.7	970	2.4	148	—	303R4	BE90S4	BX90S4	ME3SA4	MX3SA4	21000	24000	40500	48000	11300	274		
10.0	940	1.4	143	—	301R4	BE90S4	BX90S4	ME3SA4	MX3SA4	6500	6500	21500	23500	3720	264		
10.1	960	1.8	142	301L3	—	BE90S4	BX90S4	ME3SA4	MX3SA4	6480	6480	21500	23400	3700	262		
10.1	960	2.7	141	303L3	—	BE90S4	BX90S4	ME3SA4	MX3SA4	20900	23900	40400	47800	11100	272		
10.8	900	1.3	133	—	301R3	BE90S4	BX90S4	ME3SA4	MX3SA4	6340	6340	21000	23000	3620	264		
10.9	880	1.0	131	300L3	—	BE90S4	BX90S4	ME3SA4	MX3SA4	6310	6310	20900	24300	3610	252		
10.9	880	1.9	131	301L3	—	BE90S4	BX90S4	ME3SA4	MX3SA4	6310	6310	20900	22900	3610	262		
11.0	850	1.0	130	—	300R4	BE90S4	BX90S4	ME3SA4	MX3SA4	6290	6290	20900	24300	3590	254		
11.0	850	2.0	130	—	301R4	BE90S4	BX90S4	ME3SA4	MX3SA4	6290	6290	20900	22800	3590	264		
11.5	840	2.2	124	303L3	—	BE90S4	BX90S4	ME3SA4	MX3SA4	20100	22900	38800	46000	10600	272		
11.8	820	2.9	121	—	304R3	BE90S4	BX90S4	ME3SA4	MX3SA4	19900	22700	38500	45700	10500	286		
12.3	780	1.7	116	301L3	—	BE90S4	BX90S4	ME3SA4	MX3SA4	6060	6060	20200	22100	3460	262		
12.5	770	2.4	114	—	303R3	BE90S4	BX90S4	ME3SA4	MX3SA4	19500	22300	37900	44900	10300	274		
12.7	760	2.4	113	303L3	—	BE90S4	BX90S4	ME3SA4	MX3SA4	19400	22200	37700	44700	10300	272		
13.4	720	0.9	106	—	300R3	BE90S4	BX90S4	ME3SA4	MX3SA4	5890	5890	19700	22900	3370	254		
13.4	720	1.8	106	—	301R3	BE90S4	BX90S4	ME3SA4	MX3SA4	5890	5890	19700	21500	3370	264		
13.5	690	1.2	106	—	300R4	BE90S4	BX90S4	ME3SA4	MX3SA4	5880	5880	19600	22800	3360	254		
13.5	690	2.5	106	—	301R4	BE90S4	BX90S4	ME3SA4	MX3SA4	5880	5880	19600	21500	3360	264		
13.6	710	1.2	105	300L3	—	BE90S4	BX90S4	ME3SA4	MX3SA4	5860	5860	19600	22800	3350	252		
13.6	710	2.4	105	301L3	—	BE90S4	BX90S4	ME3SA4	MX3SA4	5860	5860	19600	21400	3350	262		
15.6	620	2.9	91.5	—	303R3	BE90S4	BX90S4	ME3SA4	MX3SA4	18100	20700	35400	42000	9600	274		
16.7	580	1.5	85.6	300L3	—	BE90S4	BX90S4	ME3SA4	MX3SA4	5480	5480	18400	21400	3130	252		
16.7	580	2.9	85.6	301L3	—	BE90S4	BX90S4	ME3SA4	MX3SA4	5480	5480	18400	20100	3130	262		
16.8	580	1.1	85.2	—	300R3	BE90S4	BX90S4	ME3SA4	MX3SA4	5470	5470	18400	21400	3120	254		
16.8	580	2.3	85.2	—	301R3	BE90S4	BX90S4	ME3SA4	MX3SA4	5470	5470	18400	20100	3120	264		
18.2	530	1.6	78.7	—	300R3	BE90S4	BX90S4	ME3SA4	MX3SA4	5330	5330	18000	20900	3040	254		
18.2	530	3.0	78.7	—	301R3	BE90S4	BX90S4	ME3SA4	MX3SA4	5330	5330	18000	19600	3040	264		
18.5	520	1.6	77.5	300L3	—	BE90S4	BX90S4	ME3SA4	MX3SA4	5300	5300	17900	20800	3030	252		
20.5	470	1.4	69.9	300L3	—	BE90S4	BX90S4	ME3SA4	MX3SA4	5120	5120	17300	20200	2920	252		
20.5	470	2.8	69.9	301L3	—	BE90S4	BX90S4	ME3SA4	MX3SA4	5120	5120	17300	19000	2920	262		
21.0	460	1.4	68.2	—	300R3	BE90S4	BX90S4	ME3SA4	MX3SA4	5080	5080	17200	20000	2900	254		
21.0	460	2.8	68.2	—	301R3	BE90S4	BX90S4	ME3SA4	MX3SA4	5080	5080	17200	18800	2900	264		
22.1	450	1.2	64.8	300L2	—	BE90S4	BX90S4	ME3SA4	MX3SA4	4990	4990	17000	19700	2850	252		
22.1	450	2.5	64.8	301L2	—	BE90S4	BX90S4	ME3SA4	MX3SA4	4990	4990	17000	18500	2850	262		
22.6	430	2.0	63.2	300L3	—	BE90S4	BX90S4	ME3SA4	MX3SA4	4950	4950	16800	19600	2830	252		
22.7	420	2.0	62.9	—	300R3	BE90S4	BX90S4	ME3SA4	MX3SA4	4940	4940	16800	19500	2820	254		
27.5	360	1.8	51.9	300L2	—	BE90S4	BX90S4	ME3SA4	MX3SA4	4640	4640	15900	18400	2650	252		
27.7	350	2.4	51.6	300L3	—	BE90S4	BX90S4	ME3SA4	MX3SA4	4630	4630	15800	18400	2640	252		
28.4	340	2.5	50.4	—	300R3	BE90S4	BX90S4	ME3SA4	MX3SA4	4590	4590	15700	18300	2620	254		
34	290	2.2	41.5	300L2	—	BE90S4	BX90S4	ME3SA4	MX3SA4	4300	4300	14800	17300	2460	252		
35	280	2.3	41.2	—	300R3	BE90S4	BX90S4	ME3SA4	MX3SA4	4290	4290	14800	17200	2450	254		
43	230	2.8	33.3	300L2	—	BE90S4	BX90S4	ME3SA4	MX3SA4	4000	4000	13900	16100	2280	252		
78	130	2.9	18.5	—	300R2	BE90S4	BX90S4	ME3SA4	MX3SA4	3280	3280	11600	13500	1880	254		

A

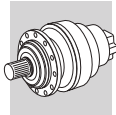

$P_1 = 1.5 \text{ kW}$

n_2 min ⁻¹	M_2 Nm	S	i			IE2		IE3		Rn ₂ [N]					
								MC	MZ	HC/PC	HZ/PZ	FZ			
0.57	22300	1.1	2523	310ML4	—	BE90LA4	BX90LA4	—	—	—	—	106500	135000	65000	344
0.65	19400	2.1	2187	313ML4	—	BE90LA4	BX90LA4	—	—	—	—	189900	222500	80000	368
0.68	18600	2.0	2096	311ML4	—	BE90LA4	BX90LA4	—	—	—	—	130300	132900	65000	356
0.71	17700	1.0	2003	309L4	—	BE90LA4	BX90LA4	—	—	—	—	91100	117300	36000	334
0.71	17900	1.3	2022	310ML4	—	BE90LA4	BX90LA4	—	—	—	—	103100	130800	65000	344
0.80	15900	1.5	1794	310ML4	—	BE90LA4	BX90LA4	—	—	—	—	101400	128600	65000	344
0.81	15600	1.0	1767	307L4	—	BE90LA4	BX90LA4	ME3SB4	MX3SB4	38900	48600	87600	115200	45000	320
0.81	15600	2.6	1766	311ML4	—	BE90LA4	BX90LA4	—	—	—	—	127100	129700	65000	356
0.83	15300	1.1	1723	309L4	—	BE90LA4	BX90LA4	—	—	—	—	89200	114800	36000	334
0.85	14900	2.5	1680	311ML4	—	BE90LA4	BX90LA4	—	—	—	—	126200	128800	65000	356
0.86	14800	1.6	1672	310ML4	—	BE90LA4	BX90LA4	—	—	—	—	100400	127300	65000	344
0.89	14200	1.2	1605	309L4	—	BE90LA4	BX90LA4	—	—	—	—	88300	113600	36000	334
0.90	14100	1.1	1591	307L4	—	BE90LA4	BX90LA4	ME3SB4	MX3SB4	38300	47900	86200	113500	45000	320
0.99	12700	1.9	1438	310ML4	—	BE90LA4	BX90LA4	—	—	0	0	98200	124600	65000	344
1.0	12500	1.3	1408	307L4	—	BE90LA4	BX90LA4	ME3SB4	MX3SB4	37700	47100	84800	111500	44800	320
1.0	12200	1.4	1380	309L4	—	BE90LA4	BX90LA4	—	—	—	—	86400	111200	35600	334
1.1	11300	1.1	1274	307L4	—	BE90LA4	BX90LA4	ME3SB4	MX3SB4	37100	46400	83600	109900	43300	320
1.1	11400	1.5	1286	309L4	—	BE90LA4	BX90LA4	—	—	—	—	85500	110100	34700	334
1.1	11100	2.2	1259	310ML4	—	BE90LA4	BX90LA4	—	—	—	—	96400	122200	62300	344
1.2	10200	1.4	1157	307L4	—	BE90LA4	BX90LA4	ME3SB4	MX3SB4	36600	45800	82400	108400	41900	320
1.2	10200	1.6	1149	309L4	—	BE90LA4	BX90LA4	—	—	—	—	84200	108300	33500	334
1.2	10300	2.8	1164	310ML4	—	BE90LA4	BX90LA4	—	—	—	—	95300	120900	60700	344
1.4	8990	1.1	1015	306L4	—	BE90LA4	BX90LA4	ME3SB4	MX3SB4	30000	34200	68300	78900	31200	308
1.4	8850	1.6	999	307L4	—	BE90LA4	BX90LA4	ME3SB4	MX3SB4	35900	44800	80700	106200	39900	320
1.4	8850	2.1	999	309L4	—	BE90LA4	BX90LA4	—	—	—	—	82500	106200	31900	334
1.6	7760	1.0	877	306L4	—	BE90LA4	BX90LA4	ME3SB4	MX3SB4	29300	33400	66900	77200	29700	308
1.6	8020	1.9	906	307L4	—	BE90LA4	BX90LA4	ME3SB4	MX3SB4	35400	44200	79600	104700	38700	320
1.6	8020	2.2	906	309L4	—	BE90LA4	BX90LA4	—	—	—	—	81400	104700	30900	334
1.6	7950	2.8	898	—	310MR4	BE90LA4	BX90LA4	—	—	—	—	91900	116500	55700	346
1.8	7160	1.1	809	306L4	—	BE90LA4	BX90LA4	ME3SB4	MX3SB4	29000	33100	66100	76300	28900	308
1.8	7090	1.9	801	307L4	—	BE90LA4	BX90LA4	ME3SB4	MX3SB4	34800	43400	78200	102900	37100	320
1.8	7090	2.6	801	309L4	—	BE90LA4	BX90LA4	—	—	—	—	79900	102900	29700	334
2.0	6190	1.5	700	306L4	—	BE90LA4	BX90LA4	ME3SB4	MX3SB4	28400	32400	64800	74800	27600	308
2.0	6390	2.4	722	307L4	—	BE90LA4	BX90LA4	ME3SB4	MX3SB4	34200	42800	77100	101400	35800	320
2.1	5890	1.0	665	—	306R4	BE90LA4	BX90LA4	ME3SB4	MX3SB4	28200	32200	64300	74200	27100	310
2.1	6110	1.6	690	—	307R4	BE90LA4	BX90LA4	—	—	34000	42500	76500	100700	35300	322
2.1	6110	2.4	690	—	309R4	BE90LA4	BX90LA4	—	—	—	—	78200	100700	28200	332
2.2	5790	2.2	654	307L4	—	BE90LA4	BX90LA4	ME3SB4	MX3SB4	33800	42200	76000	99900	34700	320
2.3	5630	1.7	636	306L4	—	BE90LA4	BX90LA4	ME3SB4	MX3SB4	28000	31900	63900	73800	26700	308
2.4	5220	1.8	589	306L4	—	BE90LA4	BX90LA4	ME3SB4	MX3SB4	27700	31600	63200	73000	26000	308
2.4	5230	1.6	590	—	306R4	BE90LA4	BX90LA4	ME3SB4	MX3SB4	27700	31600	63200	73000	26100	310
2.5	5020	1.0	567	—	305R4	BE90LA4	BX90LA4	ME3SB4	MX3SB4	23200	26500	44700	52900	17600	298
2.5	5120	2.9	579	307L4	—	BE90LA4	BX90LA4	ME3SB4	MX3SB4	33200	41500	74600	98200	33300	320
2.5	5150	2.5	581	—	307R4	BE90LA4	BX90LA4	—	—	33200	41500	74700	98300	33300	322
2.6	4920	1.1	556	305L4	—	BE90LA4	BX90LA4	ME3SB4	MX3SB4	23100	26400	44500	52800	17500	296
2.6	4870	1.5	550	—	306R4	BE90LA4	BX90LA4	ME3SB4	MX3SB4	27400	31300	62600	72200	25500	310
2.8	4510	2.1	509	306L4	—	BE90LA4	BX90LA4	ME3SB4	MX3SB4	27100	30900	61900	71500	24800	308
2.9	4360	1.2	492	305L4	—	BE90LA4	BX90LA4	ME3SB4	MX3SB4	22700	25900	43800	51900	16800	296
2.9	4320	2.1	488	—	306R4	BE90LA4	BX90LA4	ME3SB4	MX3SB4	27000	30800	61500	71000	24500	310
2.9	4340	2.2	490	—	307R4	BE90LA4	BX90LA4	—	—	32400	40500	72900	95900	31500	322
3.1	4020	1.8	455	—	306R4	BE90LA4	BX90LA4	ME3SB4	MX3SB4	26700	30500	60900	70300	23900	310
3.1	4120	3.0	465	307L4	—	BE90LA4	BX90LA4	ME3SB4	MX3SB4	32200	40200	72400	95200	30900	320
3.2	3950	0.9	446	304L4	—	BE90LA4	BX90LA4	ME3SB4	MX3SB4	22400	25600	43100	51100	16300	284
3.2	4000	0.9	452	—	304R4	BE90LA4	BX90LA4	ME3SB4	MX3SB4	22400	25600	43200	51200	16300	286
3.2	3950	1.4	446	305L4	—	BE90LA4	BX90LA4	ME3SB4	MX3SB4	22400	25600	43100	51100	16300	296
3.2	4000	1.2	452	—	305R4	BE90LA4	BX90LA4	ME3SB4	MX3SB4	22400	25600	43200	51200	16300	298
3.2	3930	2.5	444	306L4	—	BE90LA4	BX90LA4	ME3SB4	MX3SB4	26600	30400	60700	70100	23700	308
3.4	3720	2.4	420	—	306R4	BE90LA4	BX90LA4	ME3SB4	MX3SB4	26400	30100	60200	69500	23300	310
3.5	3660	1.3	413	305L4	—	BE90LA4	BX90LA4	ME3SB4	MX3SB4	22100	25300	42700	50600	15900	296
3.5	3700	1.5	405	306L3	—	BE90LA4	BX90LA4	ME3SB4	MX3SB4	26300	30000	59900	69200	23000	308
3.6	3670	1.0	402	305L3	—	BE90LA4	BX90LA4	ME3SB4	MX3SB4	22000	25200	42500	50400	15700	296
3.7	3450	1.1	390	—	305R4	BE90LA4	BX90LA4	ME3SB4	MX3SB4	22000	25100	42300	50200	15600	298
3.7	3460	2.0	391	306L4	—	BE90LA4	BX90LA4	ME3SB4	MX3SB4	26100	29800	59600	68800	22700	308
3.7	3440	2.2	389	—	306R4	BE90LA4	BX90LA4	ME3SB4	MX3SB4	26100	29800	59600	68800	22700	310
3.9	3220	0.9	364	—	304R4	BE90LA4	BX90LA4	ME3SB4	MX3SB4	21700	24800	41900	49700	15200	286

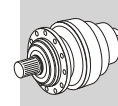

$P_1 = 1.5 \text{ kW}$

n ₂ min ⁻¹	M ₂ Nm	S	i	IE2		IE3		IE2		IE3		Rn ₂ [N]					📄
				MC	MZ	HC/PC	HZ/PZ	FZ									
3.9	3220	1.4	364	—	305R4	BE90LA4	BX90LA4	ME3SB4	MX3SB4	21700	24800	41900	49700	15200	298		
4.3	2970	1.5	336	—	305R4	BE90LA4	BX90LA4	ME3SB4	MX3SB4	21500	24600	41400	49100	14800	298		
4.3	3070	2.9	336	307L3	—	BE90LA4	BX90LA4	ME3SB4	MX3SB4	30700	38400	69100	90900	27800	320		
4.4	2930	1.2	321	305L3	—	BE90LA4	BX90LA4	ME3SB4	MX3SB4	21400	24400	41200	48800	14600	296		
4.4	2960	1.9	325	306L3	—	BE90LA4	BX90LA4	ME3SB4	MX3SB4	25500	29000	58000	67000	21300	308		
4.6	2770	1.3	313	—	305R4	BE90LA4	BX90LA4	ME3SB4	MX3SB4	21300	24300	41000	48600	14500	298		
4.6	2760	2.8	312	—	306R4	BE90LA4	BX90LA4	ME3SB4	MX3SB4	25300	28900	57700	66600	21100	310		
4.7	2710	1.3	307	—	304R4	BE90LA4	BX90LA4	ME3SB4	MX3SB4	21200	24200	40900	48500	14400	286		
4.9	2570	1.0	290	—	303R4	BE90LA4	BX90LA4	ME3SB4	MX3SB4	21000	24000	40600	48100	14100	274		
4.9	2570	1.4	290	—	304R4	BE90LA4	BX90LA4	ME3SB4	MX3SB4	21000	24000	40600	48100	14100	286		
4.9	2570	2.1	290	—	305R4	BE90LA4	BX90LA4	ME3SB4	MX3SB4	21000	24000	40600	48100	14100	298		
5.0	2630	2.1	288	306L3	—	BE90LA4	BX90LA4	ME3SB4	MX3SB4	25000	28500	57100	65900	20500	308		
5.2	2490	1.0	273	304L3	—	BE90LA4	BX90LA4	ME3SB4	MX3SB4	21000	24000	40500	48000	13800	284		
5.2	2520	1.8	276	305L3	—	BE90LA4	BX90LA4	ME3SB4	MX3SB4	21000	24000	40500	48000	13900	296		
5.3	2370	1.6	267	—	304R4	BE90LA4	BX90LA4	ME3SB4	MX3SB4	21000	24000	40500	48000	13700	286		
5.3	2450	2.2	268	306L3	—	BE90LA4	BX90LA4	ME3SB4	MX3SB4	25000	28500	57000	65800	20000	308		
5.6	2350	1.5	258	305L3	—	BE90LA4	BX90LA4	ME3SB4	MX3SB4	21000	24000	40500	48000	13600	296		
5.6	2260	1.6	255	—	305R4	BE90LA4	BX90LA4	ME3SB4	MX3SB4	21000	24000	40500	48000	13500	298		
6.2	2050	1.8	231	—	305R4	BE90LA4	BX90LA4	ME3SB4	MX3SB4	21000	24000	40500	48000	13100	298		
6.3	2010	1.7	227	—	304R4	BE90LA4	BX90LA4	ME3SB4	MX3SB4	21000	24000	40500	48000	13000	286		
6.5	2010	1.1	220	303L3	—	BE90LA4	BX90LA4	ME3SB4	MX3SB4	21000	24000	40500	48000	12900	272		
6.5	2010	1.8	220	304L3	—	BE90LA4	BX90LA4	ME3SB4	MX3SB4	21000	24000	40500	48000	12900	284		
6.5	2010	2.4	220	305L3	—	BE90LA4	BX90LA4	ME3SB4	MX3SB4	21000	24000	40500	48000	12900	296		
6.7	1900	1.0	215	—	301R4	BE90LA4	BX90LA4	ME3SB4	MX3SB4	6500	6500	21500	23500	4250	264		
6.7	1900	1.4	214	—	303R4	BE90LA4	BX90LA4	ME3SB4	MX3SB4	21000	24000	40500	48000	12700	274		
6.7	1900	1.9	214	—	304R4	BE90LA4	BX90LA4	ME3SB4	MX3SB4	21000	24000	40500	48000	12700	286		
6.7	1900	2.8	214	—	305R4	BE90LA4	BX90LA4	ME3SB4	MX3SB4	21000	24000	40500	48000	12700	298		
7.1	1840	1.3	202	304L3	—	BE90LA4	BX90LA4	ME3SB4	MX3SB4	21000	24000	40500	48000	12500	284		
7.5	1740	1.1	190	303L3	—	BE90LA4	BX90LA4	ME3SB4	MX3SB4	21000	24000	40500	48000	12300	272		
7.5	1740	2.1	190	305L3	—	BE90LA4	BX90LA4	ME3SB4	MX3SB4	21000	24000	40500	48000	12300	296		
7.7	1640	1.4	185	—	303R4	BE90LA4	BX90LA4	ME3SB4	MX3SB4	21000	24000	40500	48000	12100	274		
7.7	1640	2.1	185	—	304R4	BE90LA4	BX90LA4	ME3SB4	MX3SB4	21000	24000	40500	48000	12100	286		
7.7	1640	2.7	185	—	305R4	BE90LA4	BX90LA4	ME3SB4	MX3SB4	21000	24000	40500	48000	12100	298		
8.1	1620	1.1	177	301L3	—	BE90LA4	BX90LA4	ME3SB4	MX3SB4	6500	6500	21500	23500	3990	262		
8.1	1550	1.1	175	—	301R4	BE90LA4	BX90LA4	ME3SB4	MX3SB4	6500	6500	21500	23500	3980	264		
8.1	1620	1.4	178	303L3	—	BE90LA4	BX90LA4	ME3SB4	MX3SB4	21000	24000	40500	48000	12000	272		
8.1	1620	1.8	178	304L3	—	BE90LA4	BX90LA4	ME3SB4	MX3SB4	21000	24000	40500	48000	12000	284		
8.1	1620	2.7	178	305L3	—	BE90LA4	BX90LA4	ME3SB4	MX3SB4	21000	24000	40500	48000	12000	296		
8.7	1490	1.5	164	303L3	—	BE90LA4	BX90LA4	ME3SB4	MX3SB4	21000	24000	40500	48000	11700	272		
8.7	1500	1.6	165	304L3	—	BE90LA4	BX90LA4	ME3SB4	MX3SB4	21000	24000	40500	48000	11700	284		
8.7	1490	3.0	164	305L3	—	BE90LA4	BX90LA4	ME3SB4	MX3SB4	21000	24000	40500	48000	11700	296		
9.0	1410	1.2	159	—	301R4	BE90LA4	BX90LA4	ME3SB4	MX3SB4	6500	6500	21500	23500	3850	264		
9.0	1400	1.9	158	—	303R4	BE90LA4	BX90LA4	ME3SB4	MX3SB4	21000	24000	40500	48000	11500	274		
9.0	1400	2.5	158	—	304R4	BE90LA4	BX90LA4	ME3SB4	MX3SB4	21000	24000	40500	48000	11500	286		
9.4	1390	1.3	152	303L3	—	BE90LA4	BX90LA4	ME3SB4	MX3SB4	21000	24000	40500	48000	11400	272		
9.4	1390	2.6	152	305L3	—	BE90LA4	BX90LA4	ME3SB4	MX3SB4	21000	24000	40500	48000	11400	296		
9.6	1360	2.5	150	304L3	—	BE90LA4	BX90LA4	ME3SB4	MX3SB4	21000	24000	40500	48000	11300	284		
9.7	1310	1.8	148	—	303R4	BE90LA4	BX90LA4	ME3SB4	MX3SB4	21000	24000	40500	48000	11300	274		
9.7	1310	2.6	148	—	304R4	BE90LA4	BX90LA4	ME3SB4	MX3SB4	21000	24000	40500	48000	11300	286		
10.0	1270	1.0	143	—	301R4	BE90LA4	BX90LA4	ME3SB4	MX3SB4	6500	6500	21500	23500	3720	264		
10.1	1300	1.3	142	301L3	—	BE90LA4	BX90LA4	ME3SB4	MX3SB4	6480	6480	21500	23400	3700	262		
10.1	1290	2.0	141	303L3	—	BE90LA4	BX90LA4	ME3SB4	MX3SB4	20900	23900	40400	47800	11100	272		
10.1	1290	2.7	141	304L3	—	BE90LA4	BX90LA4	ME3SB4	MX3SB4	20900	23900	40400	47800	11100	284		
10.8	1210	0.9	133	—	301R3	BE90LA4	BX90LA4	ME3SB4	MX3SB4	6340	6340	21000	23000	3620	264		
10.9	1190	1.4	131	301L3	—	BE90LA4	BX90LA4	ME3SB4	MX3SB4	6310	6310	20900	22900	3610	262		
11.0	1150	1.5	130	—	301R4	BE90LA4	BX90LA4	ME3SB4	MX3SB4	6290	6290	20900	22800	3590	264		
11.0	1190	3.0	130	304L3	—	BE90LA4	BX90LA4	ME3SB4	MX3SB4	20400	23300	39400	46700	10800	284		
11.1	1140	2.3	129	—	303R4	BE90LA4	BX90LA4	ME3SB4	MX3SB4	20300	23200	39300	46600	10800	274		
11.5	1140	1.6	124	303L3	—	BE90LA4	BX90LA4	ME3SB4	MX3SB4	20100	22900	38800	46000	10600	272		
11.8	1110	2.2	121	—	304R3	BE90LA4	BX90LA4	ME3SB4	MX3SB4	19900	22700	38500	45700	10500	286		
12.3	1060	1.2	116	301L3	—	BE90LA4	BX90LA4	ME3SB4	MX3SB4	6060	6060	20200	22100	3460	262		
12.5	1040	1.7	114	—	303R3	BE90LA4	BX90LA4	ME3SB4	MX3SB4	19500	22300	37900	44900	10300	274		
12.7	1030	1.8	113	303L3	—	BE90LA4	BX90LA4	ME3SB4	MX3SB4	19400	22200	37700	44700	10300	272		
13.4	970	1.3	106	—	301R3	BE90LA4	BX90LA4	ME3SB4	MX3SB4	5890	5890	19700	21500	3370	264		
13.5	940	0.9	106	—	300R4	BE90LA4	BX90LA4	ME3SB4	MX3SB4	5880	5880	19600	22800	3360	254		

A

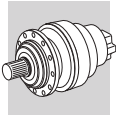

$P_1 = 1.5 \text{ kW}$

n_2 min ⁻¹	M_2 Nm	S	i	IE2		IE3		IE2		IE3		Rn ₂ [N]					
				MC	MZ	HC/PC	HZ/PZ	FZ									
13.5	940	1.8	106	—	301R4	BE90LA4	BX90LA4	ME3SB4	MX3SB4	5880	5880	19600	21500	3360	264		
13.6	960	1.8	105	301L3	—	BE90LA4	BX90LA4	ME3SB4	MX3SB4	5860	5860	19600	21400	3350	262		
13.7	950	2.7	105	303L3	—	BE90LA4	BX90LA4	ME3SB4	MX3SB4	18900	21600	36900	43700	10000	272		
14.7	890	2.7	97.0	—	304R3	BE90LA4	BX90LA4	ME3SB4	MX3SB4	18500	21100	36000	42700	9790	286		
15.6	840	2.2	91.5	—	303R3	BE90LA4	BX90LA4	ME3SB4	MX3SB4	18100	20700	35400	42000	9600	274		
15.9	820	2.7	90.2	303L3	—	BE90LA4	BX90LA4	ME3SB4	MX3SB4	18000	20600	35300	41800	9550	272		
16.7	780	1.1	85.6	300L3	—	BE90LA4	BX90LA4	ME3SB4	MX3SB4	5480	5480	18400	21400	3130	252		
16.7	780	2.2	85.6	301L3	—	BE90LA4	BX90LA4	ME3SB4	MX3SB4	5480	5480	18400	20100	3130	262		
16.8	780	1.7	85.2	—	301R3	BE90LA4	BX90LA4	ME3SB4	MX3SB4	5470	5470	18400	20100	3120	264		
18.2	720	1.2	78.7	—	300R3	BE90LA4	BX90LA4	ME3SB4	MX3SB4	5330	5330	18000	20900	3040	254		
18.2	720	2.2	78.7	—	301R3	BE90LA4	BX90LA4	ME3SB4	MX3SB4	5330	5330	18000	19600	3040	264		
18.5	710	1.2	77.5	300L3	—	BE90LA4	BX90LA4	ME3SB4	MX3SB4	5300	5300	17900	20800	3030	252		
18.5	710	2.4	77.5	301L3	—	BE90LA4	BX90LA4	ME3SB4	MX3SB4	5300	5300	17900	19600	3030	262		
19.5	670	2.7	73.3	—	303R3	BE90LA4	BX90LA4	ME3SB4	MX3SB4	16800	19200	33100	39300	8920	274		
20.5	640	1.0	69.9	300L3	—	BE90LA4	BX90LA4	ME3SB4	MX3SB4	5120	5120	17300	20200	2920	252		
20.5	640	2.0	69.9	301L3	—	BE90LA4	BX90LA4	ME3SB4	MX3SB4	5120	5120	17300	19000	2920	262		
21.0	620	1.0	68.2	—	300R3	BE90LA4	BX90LA4	ME3SB4	MX3SB4	5080	5080	17200	20000	2900	254		
21.0	620	2.1	68.2	—	301R3	BE90LA4	BX90LA4	ME3SB4	MX3SB4	5080	5080	17200	18800	2900	264		
22.1	610	0.9	64.8	300L2	—	BE90LA4	BX90LA4	ME3SB4	MX3SB4	4990	4990	17000	19700	2850	252		
22.1	610	1.9	64.8	301L2	—	BE90LA4	BX90LA4	ME3SB4	MX3SB4	4990	4990	17000	18500	2850	262		
22.6	580	1.5	63.2	300L3	—	BE90LA4	BX90LA4	ME3SB4	MX3SB4	4950	4950	16800	19600	2830	252		
22.6	580	2.9	63.2	301L3	—	BE90LA4	BX90LA4	ME3SB4	MX3SB4	4950	4950	16800	18400	2830	262		
22.7	570	1.5	62.9	—	300R3	BE90LA4	BX90LA4	ME3SB4	MX3SB4	4940	4940	16800	19500	2820	254		
22.7	570	2.9	62.9	—	301R3	BE90LA4	BX90LA4	ME3SB4	MX3SB4	4940	4940	16800	18400	2820	264		
27.5	490	1.3	51.9	300L2	—	BE90LA4	BX90LA4	ME3SB4	MX3SB4	4640	4640	15900	18400	2650	252		
27.5	490	2.7	51.9	301L2	—	BE90LA4	BX90LA4	ME3SB4	MX3SB4	4640	4640	15900	17300	2650	262		
27.7	470	1.8	51.6	300L3	—	BE90LA4	BX90LA4	ME3SB4	MX3SB4	4630	4630	15800	18400	2640	252		
28.4	460	1.8	50.4	—	300R3	BE90LA4	BX90LA4	ME3SB4	MX3SB4	4590	4590	15700	18300	2620	254		
34	390	1.7	41.5	300L2	—	BE90LA4	BX90LA4	ME3SB4	MX3SB4	4300	4300	14800	17300	2460	252		
35	380	1.7	41.2	—	300R3	BE90LA4	BX90LA4	ME3SB4	MX3SB4	4290	4290	14800	17200	2450	254		
37	360	2.3	38.4	300L2	—	BE90LA4	BX90LA4	ME3SB4	MX3SB4	4190	4190	14500	16800	2390	252		
38	340	2.5	37.3	—	300R3	BE90LA4	BX90LA4	ME3SB4	MX3SB4	4150	4150	14400	16700	2370	254		
43	310	2.1	33.3	300L2	—	BE90LA4	BX90LA4	ME3SB4	MX3SB4	4000	4000	13900	16100	2280	252		
47	290	2.9	30.7	300L2	—	BE90LA4	BX90LA4	ME3SB4	MX3SB4	3890	3890	13600	15800	2220	252		
78	170	2.1	18.5	—	300R2	BE90LA4	BX90LA4	ME3SB4	MX3SB4	3280	3280	11600	13500	1880	254		

$P_1 = 2.2 \text{ kW}$

n_2 min ⁻¹	M_2 Nm	S	i	IE2		IE3		IE2		IE3		Rn ₂ [N]					
				MC	MZ	HC/PC	HZ/PZ	FZ									
0.65	28500	1.4	2187	313ML4	—	BE100LA4	BX100LA4	—	—	—	—	189900	222500	80000	368		
0.68	27300	1.3	2096	311ML4	—	BE100LA4	BX100LA4	—	—	—	—	130300	132900	65000	356		
0.71	26300	0.9	2022	310ML4	—	BE100LA4	BX100LA4	—	—	—	—	103100	130800	65000	344		
0.79	23600	2.4	1817	313ML4	—	BE100LA4	BX100LA4	—	—	—	—	184900	216700	80000	368		
0.80	23400	1.0	1794	310ML4	—	BE100LA4	BX100LA4	—	—	—	—	101400	128600	65000	344		
0.81	23000	1.8	1766	311ML4	—	BE100LA4	BX100LA4	—	—	—	—	127100	129700	65000	356		
0.85	21900	1.7	1680	311ML4	—	BE100LA4	BX100LA4	—	—	—	—	126200	128800	65000	356		
0.86	21800	1.1	1672	310ML4	—	BE100LA4	BX100LA4	—	—	—	—	100400	127300	65000	344		
0.95	19500	2.9	1502	313ML4	—	BE100LA4	BX100LA4	—	—	—	—	180000	210900	80000	368		
0.99	18700	1.3	1438	310ML4	—	BE100LA4	BX100LA4	—	—	—	—	98200	124600	65000	344		
1.0	18000	0.9	1380	309L4	—	BE100LA4	BX100LA4	—	—	—	—	86400	111200	35600	334		
1.0	18400	2.2	1415	311ML4	—	BE100LA4	BX100LA4	—	—	—	—	123200	125700	64800	356		
1.0	18100	2.8	1394	313ML4	—	BE100LA4	BX100LA4	—	—	—	—	178100	208700	79300	368		
1.1	16700	1.0	1286	309L4	—	BE100LA4	BX100LA4	—	—	—	—	85500	110100	34700	334		
1.1	16400	1.5	1259	310ML4	—	BE100LA4	BX100LA4	—	—	—	—	96400	122200	62300	344		
1.2	15100	1.0	1157	307L4	—	BE100LA4	BX100LA4	ME3LA4	MX3LA4	36600	45800	82400	108400	41900	320		
1.2	15000	1.1	1149	309L4	—	BE100LA4	BX100LA4	—	—	—	—	84200	108300	33500	334		
1.2	15200	1.9	1164	310ML4	—	BE100LA4	BX100LA4	—	—	—	—	95300	120900	60700	344		
1.2	16000	2.9	1230	311ML4	—	BE100LA4	BX100LA4	—	—	—	—	120700	123200	61800	356		
1.4	13000	1.1	999	307L4	—	BE100LA4	BX100LA4	ME3LA4	MX3LA4	35900	44800	80700	106200	39900	320		
1.4	13000	1.4	999	309L4	—	BE100LA4	BX100LA4	—	—	—	—	82500	106200	31900	334		
1.4	13000	2.2	1002	310ML4	—	BE100LA4	BX100LA4	—	—	—	—	93300	118300	57700	344		

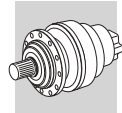

$P_1 = 2.2 \text{ kW}$

n ₂ min ⁻¹	M ₂ Nm	S	i	IE2		IE3		Rn ₂ [N]					Icon		
				IE2	IE3	IE2	IE3	MC	MZ	HC/PC	HZ/PZ	FZ			
1.5	12700	2.5	974	310ML4	—	BE100LA4	BX100LA4	—	—	—	—	92900	117800	57200	344
1.6	11800	1.3	906	307L4	—	BE100LA4	BX100LA4	ME3LA4	MX3LA4	35400	44200	79600	104700	38700	320
1.6	11800	1.5	906	309L4	—	BE100LA4	BX100LA4	—	—	—	—	81400	104700	30900	334
1.6	11700	1.9	898	—	310MR4	BE100LA4	BX100LA4	—	—	—	—	91900	116500	55700	346
1.8	10400	1.3	801	307L4	—	BE100LA4	BX100LA4	ME3LA4	MX3LA4	34800	43400	78200	102900	37100	320
1.8	10400	1.7	801	309L4	—	BE100LA4	BX100LA4	—	—	—	—	79900	102900	29700	334
1.8	10400	2.6	798	310ML4	—	BE100LA4	BX100LA4	—	—	—	—	90300	114500	53500	344
1.9	9850	2.5	757	—	310MR4	BE100LA4	BX100LA4	—	—	—	—	89600	113600	52600	346
2.0	9100	1.0	700	306L4	—	BE100LA4	BX100LA4	ME3LA4	MX3LA4	28400	32400	64800	74800	27600	308
2.0	9400	1.6	722	307L4	—	BE100LA4	BX100LA4	ME3LA4	MX3LA4	34200	42800	77100	101400	35800	320
2.0	9400	2.3	722	309L4	—	BE100LA4	BX100LA4	—	—	—	—	78800	101400	28700	334
2.0	9440	2.8	726	310ML4	—	BE100LA4	BX100LA4	—	—	—	—	89100	113000	51800	344
2.1	8980	1.1	690	—	307R4	BE100LA4	BX100LA4	—	—	34000	42500	76500	100700	35300	322
2.1	8980	1.7	690	—	309R4	BE100LA4	BX100LA4	—	—	—	—	78200	100700	28200	332
2.2	8500	1.5	654	307L4	—	BE100LA4	BX100LA4	ME3LA4	MX3LA4	33800	42200	76000	99900	34700	320
2.2	8500	2.1	654	309L4	—	BE100LA4	BX100LA4	—	—	—	—	77600	99900	27700	334
2.2	8310	2.5	639	—	310MR4	BE100LA4	BX100LA4	—	—	—	—	87500	110900	49700	346
2.3	8270	1.1	636	306L4	—	BE100LA4	BX100LA4	ME3LA4	MX3LA4	28000	31900	63900	73800	26700	308
2.4	7670	1.2	589	306L4	—	BE100LA4	BX100LA4	ME3LA4	MX3LA4	27700	31600	63200	73000	26000	308
2.4	7680	1.1	590	—	306R4	BE100LA4	BX100LA4	ME3LA4	MX3LA4	27700	31600	63200	73000	26100	310
2.4	7670	2.5	590	—	310MR4	BE100LA4	BX100LA4	—	—	—	—	86500	109700	48400	346
2.5	7530	2.0	579	307L4	—	BE100LA4	BX100LA4	ME3LA4	MX3LA4	33200	41500	74600	98200	33300	320
2.5	7560	1.7	581	—	307R4	BE100LA4	BX100LA4	—	—	33200	41500	74700	98300	33300	322
2.5	7530	2.8	579	309L4	—	BE100LA4	BX100LA4	—	—	—	—	76300	98200	26600	334
2.5	7560	2.1	581	—	309R4	BE100LA4	BX100LA4	—	—	—	—	76400	98300	26700	332
2.6	7160	1.0	550	—	306R4	BE100LA4	BX100LA4	ME3LA4	MX3LA4	27400	31300	62600	72200	25500	310
2.8	6630	1.4	509	306L4	—	BE100LA4	BX100LA4	ME3LA4	MX3LA4	27100	30900	61900	71500	24800	308
2.8	6630	2.1	509	307L4	—	BE100LA4	BX100LA4	ME3LA4	MX3LA4	32600	40700	73300	96400	31900	320
2.8	6630	2.2	509	309L4	—	BE100LA4	BX100LA4	—	—	—	—	74900	96400	25500	334
2.9	6350	1.4	488	—	306R4	BE100LA4	BX100LA4	ME3LA4	MX3LA4	27000	30800	61500	71000	24500	310
2.9	6380	1.5	490	—	307R4	BE100LA4	BX100LA4	—	—	32400	40500	72900	95900	31500	322
2.9	6380	2.2	490	—	309R4	BE100LA4	BX100LA4	—	—	—	—	74500	95900	25200	332
3.1	5920	1.2	455	—	306R4	BE100LA4	BX100LA4	ME3LA4	MX3LA4	26700	30500	60900	70300	23900	310
3.1	6050	2.0	465	307L4	—	BE100LA4	BX100LA4	ME3LA4	MX3LA4	32200	40200	72400	95200	30900	320
3.1	5950	2.3	457	—	309R4	BE100LA4	BX100LA4	—	—	—	—	73800	94900	24600	332
3.2	5800	0.9	446	305L4	—	BE100LA4	BX100LA4	ME3LA4	MX3LA4	22400	25600	43100	51100	16300	296
3.2	5780	1.7	444	306L4	—	BE100LA4	BX100LA4	ME3LA4	MX3LA4	26600	30400	60700	70100	23700	308
3.2	5890	2.3	453	—	307R4	BE100LA4	BX100LA4	—	—	32000	40000	72100	94800	30700	322
3.4	5460	1.6	420	—	306R4	BE100LA4	BX100LA4	ME3LA4	MX3LA4	26400	30100	60200	69500	23300	310
3.5	5430	1.0	405	306L3	—	BE100LA4	BX100LA4	ME3LA4	MX3LA4	26300	30000	59900	69200	23000	308
3.5	5280	2.3	406	307L4	—	BE100LA4	BX100LA4	ME3LA4	MX3LA4	31500	39400	71000	93300	29600	320
3.5	5380	2.2	413	—	307R4	BE100LA4	BX100LA4	—	—	31600	39500	71100	93600	29800	322
3.7	5090	1.4	391	306L4	—	BE100LA4	BX100LA4	ME3LA4	MX3LA4	26100	29800	59600	68800	22700	308
3.7	5060	1.5	389	—	306R4	BE100LA4	BX100LA4	ME3LA4	MX3LA4	26100	29800	59600	68800	22700	310
3.8	4870	2.9	374	—	309R4	BE100LA4	BX100LA4	—	—	—	—	71700	92300	23000	332
3.9	4740	1.0	364	—	305R4	BE100LA4	BX100LA4	ME3LA4	MX3LA4	21700	24800	41900	49700	15200	298
3.9	4720	2.6	363	—	307R4	BE100LA4	BX100LA4	—	—	31000	38800	69800	91900	28500	322
4.3	4370	1.1	336	—	305R4	BE100LA4	BX100LA4	ME3LA4	MX3LA4	21500	24600	41400	49100	14800	298
4.3	4510	2.0	336	307L3	—	BE100LA4	BX100LA4	ME3LA4	MX3LA4	30700	38400	69100	90900	27800	320
4.3	4310	2.7	331	—	307R4	BE100LA4	BX100LA4	—	—	30600	38300	68900	90700	27600	322
4.3	4510	2.9	336	309L3	—	BE100LA4	BX100LA4	—	—	—	—	70600	90900	22200	334
4.4	4350	1.3	325	306L3	—	BE100LA4	BX100LA4	ME3LA4	MX3LA4	25500	29000	58000	67000	21300	308
4.6	4060	1.9	312	—	306R4	BE100LA4	BX100LA4	ME3LA4	MX3LA4	25300	28900	57700	66600	21100	310
4.9	3770	1.0	290	—	304R4	BE100LA4	BX100LA4	ME3LA4	MX3LA4	21000	24000	40600	48100	14100	286
4.9	3770	1.4	290	—	305R4	BE100LA4	BX100LA4	ME3LA4	MX3LA4	21000	24000	40600	48100	14100	298
4.9	3760	2.2	289	—	306R4	BE100LA4	BX100LA4	ME3LA4	MX3LA4	25000	28500	57100	65900	20500	310
5.0	3860	1.4	288	306L3	—	BE100LA4	BX100LA4	ME3LA4	MX3LA4	25000	28500	57100	65900	20500	308
5.0	3800	3.0	284	307L3	—	BE100LA4	BX100LA4	ME3LA4	MX3LA4	30000	37500	67500	88800	26200	320
5.2	3710	1.2	276	305L3	—	BE100LA4	BX100LA4	ME3LA4	MX3LA4	21000	24000	40500	48000	13900	296
5.3	3480	1.1	267	—	304R4	BE100LA4	BX100LA4	ME3LA4	MX3LA4	21000	24000	40500	48000	13700	286
5.3	3600	1.5	268	306L3	—	BE100LA4	BX100LA4	ME3LA4	MX3LA4	25000	28500	57000	65800	20000	308
5.6	3460	1.0	258	305L3	—	BE100LA4	BX100LA4	ME3LA4	MX3LA4	21000	24000	40500	48000	13600	296
5.6	3320	1.1	255	—	305R4	BE100LA4	BX100LA4	ME3LA4	MX3LA4	21000	24000	40500	48000	13500	298
5.8	3240	2.5	249	—	306R4	BE100LA4	BX100LA4	ME3LA4	MX3LA4	25000	28500	57000	65800	19500	310
6.0	3190	2.6	238	306L3	—	BE100LA4	BX100LA4	ME3LA4	MX3LA4	25000	28500	57000	65800	19300	308



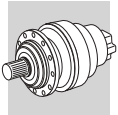

$P_1 = 2.2 \text{ kW}$

n_2 min ⁻¹	M_2 Nm	S	i	IE2		IE3		IE2		IE3		R _{n2} [N]					
				MC	MZ	HC/PC	HZ/PZ	FZ									
6.0	3210	2.7	239	307L3	—	BE100LA4	BX100LA4	ME3LA4	MX3LA4	30000	37500	67500	88800	24800	320		
6.2	3010	1.2	231	—	305R4	BE100LA4	BX100LA4	ME3LA4	MX3LA4	21000	24000	40500	48000	13100	298		
6.2	3000	2.5	230	—	306R4	BE100LA4	BX100LA4	ME3LA4	MX3LA4	25000	28500	57000	65800	19000	310		
6.3	2950	1.2	227	—	304R4	BE100LA4	BX100LA4	ME3LA4	MX3LA4	21000	24000	40500	48000	13000	286		
6.4	2980	2.2	222	306L3	—	BE100LA4	BX100LA4	ME3LA4	MX3LA4	25000	28500	57000	65800	18800	308		
6.5	2960	1.2	220	304L3	—	BE100LA4	BX100LA4	ME3LA4	MX3LA4	21000	24000	40500	48000	12900	284		
6.5	2960	1.6	220	305L3	—	BE100LA4	BX100LA4	ME3LA4	MX3LA4	21000	24000	40500	48000	12900	296		
6.7	2790	1.0	214	—	303R4	BE100LA4	BX100LA4	ME3LA4	MX3LA4	21000	24000	40500	48000	12700	274		
6.7	2790	1.3	214	—	304R4	BE100LA4	BX100LA4	ME3LA4	MX3LA4	21000	24000	40500	48000	12700	286		
6.7	2790	1.9	214	—	305R4	BE100LA4	BX100LA4	ME3LA4	MX3LA4	21000	24000	40500	48000	12700	298		
7.0	2750	3.0	205	306L3	—	BE100LA4	BX100LA4	ME3LA4	MX3LA4	25000	28500	57000	65800	18300	308		
7.5	2550	1.4	190	305L3	—	BE100LA4	BX100LA4	ME3LA4	MX3LA4	21000	24000	40500	48000	12300	296		
7.5	2550	2.6	190	306L3	—	BE100LA4	BX100LA4	ME3LA4	MX3LA4	25000	28500	57000	65800	17900	308		
7.7	2410	1.0	185	—	303R4	BE100LA4	BX100LA4	ME3LA4	MX3LA4	21000	24000	40500	48000	12100	274		
7.7	2410	1.4	185	—	304R4	BE100LA4	BX100LA4	ME3LA4	MX3LA4	21000	24000	40500	48000	12100	286		
7.7	2410	1.9	185	—	305R4	BE100LA4	BX100LA4	ME3LA4	MX3LA4	21000	24000	40500	48000	12100	298		
8.1	2380	0.9	178	303L3	—	BE100LA4	BX100LA4	ME3LA4	MX3LA4	21000	24000	40500	48000	12000	272		
8.1	2380	1.2	178	304L3	—	BE100LA4	BX100LA4	ME3LA4	MX3LA4	21000	24000	40500	48000	12000	284		
8.1	2380	1.9	178	305L3	—	BE100LA4	BX100LA4	ME3LA4	MX3LA4	21000	24000	40500	48000	12000	296		
8.7	2200	1.0	164	303L3	—	BE100LA4	BX100LA4	ME3LA4	MX3LA4	21000	24000	40500	48000	11700	272		
8.7	2210	1.1	165	304L3	—	BE100LA4	BX100LA4	ME3LA4	MX3LA4	21000	24000	40500	48000	11700	284		
8.7	2200	2.0	164	305L3	—	BE100LA4	BX100LA4	ME3LA4	MX3LA4	21000	24000	40500	48000	11700	296		
9.0	2060	1.3	158	—	303R4	BE100LA4	BX100LA4	ME3LA4	MX3LA4	21000	24000	40500	48000	11500	274		
9.0	2060	1.7	158	—	304R4	BE100LA4	BX100LA4	ME3LA4	MX3LA4	21000	24000	40500	48000	11500	286		
9.0	2060	2.6	158	—	305R4	BE100LA4	BX100LA4	ME3LA4	MX3LA4	21000	24000	40500	48000	11500	298		
9.4	2050	1.8	152	305L3	—	BE100LA4	BX100LA4	ME3LA4	MX3LA4	21000	24000	40500	48000	11400	296		
9.6	2010	1.7	150	304L3	—	BE100LA4	BX100LA4	ME3LA4	MX3LA4	21000	24000	40500	48000	11300	284		
9.7	1930	1.2	148	—	303R4	BE100LA4	BX100LA4	ME3LA4	MX3LA4	21000	24000	40500	48000	11300	274		
9.7	1930	1.8	148	—	304R4	BE100LA4	BX100LA4	ME3LA4	MX3LA4	21000	24000	40500	48000	11300	286		
9.7	1930	2.3	148	—	305R4	BE100LA4	BX100LA4	ME3LA4	MX3LA4	21000	24000	40500	48000	11300	298		
9.9	1930	2.8	144	—	306R3	BE100LA4	BX100LA4	ME3LA4	MX3LA4	25000	28500	57000	65800	16300	310		
10.1	1900	0.9	142	301L3	—	BE100LA4	BX100LA4	ME3LA4	MX3LA4	6480	6480	21500	23400	3700	262		
10.1	1900	1.4	141	303L3	—	BE100LA4	BX100LA4	ME3LA4	MX3LA4	20900	23900	40400	47800	11100	272		
10.1	1900	1.9	141	304L3	—	BE100LA4	BX100LA4	ME3LA4	MX3LA4	20900	23900	40400	47800	11100	284		
10.1	1900	2.8	141	305L3	—	BE100LA4	BX100LA4	ME3LA4	MX3LA4	20900	23900	40400	47800	11100	296		
10.9	1760	1.0	131	301L3	—	BE100LA4	BX100LA4	ME3LA4	MX3LA4	6310	6310	20900	22900	3610	262		
11.0	1690	1.0	130	—	301R4	BE100LA4	BX100LA4	—	—	6290	6290	20900	22800	3590	264		
11.0	1750	2.0	130	304L3	—	BE100LA4	BX100LA4	ME3LA4	MX3LA4	20400	23300	39400	46700	10800	284		
11.1	1680	1.6	129	—	303R4	BE100LA4	BX100LA4	ME3LA4	MX3LA4	20300	23200	39300	46600	10800	274		
11.1	1680	2.1	129	—	304R4	BE100LA4	BX100LA4	ME3LA4	MX3LA4	20300	23200	39300	46600	10800	286		
11.5	1670	1.1	124	303L3	—	BE100LA4	BX100LA4	ME3LA4	MX3LA4	20100	22900	38800	46000	10600	272		
11.5	1670	2.2	124	305L3	—	BE100LA4	BX100LA4	ME3LA4	MX3LA4	20100	22900	38800	46000	10600	296		
11.8	1630	1.5	121	—	304R3	BE100LA4	BX100LA4	ME3LA4	MX3LA4	19900	22700	38500	45700	10500	286		
12.5	1530	1.2	114	—	303R3	BE100LA4	BX100LA4	ME3LA4	MX3LA4	19500	22300	37900	44900	10300	274		
12.5	1530	2.3	114	—	305R3	BE100LA4	BX100LA4	ME3LA4	MX3LA4	19500	22300	37900	44900	10300	298		
12.7	1510	1.2	113	303L3	—	BE100LA4	BX100LA4	ME3LA4	MX3LA4	19400	22200	37700	44700	10300	272		
12.7	1510	2.4	113	305L3	—	BE100LA4	BX100LA4	ME3LA4	MX3LA4	19400	22200	37700	44700	10300	296		
12.9	1480	2.3	111	304L3	—	BE100LA4	BX100LA4	ME3LA4	MX3LA4	19300	22000	37500	44400	10200	284		
13.1	1420	2.4	109	—	304R4	BE100LA4	BX100LA4	ME3LA4	MX3LA4	19200	22000	37400	44300	10200	286		
13.4	1430	0.9	106	—	301R3	BE100LA4	BX100LA4	ME3LA4	MX3LA4	5890	5890	19700	21500	3370	264		
13.5	1380	1.2	106	—	301R4	BE100LA4	BX100LA4	—	—	5880	5880	19600	21500	3360	264		
13.6	1410	1.2	105	301L3	—	BE100LA4	BX100LA4	ME3LA4	MX3LA4	5860	5860	19600	21400	3350	262		
13.7	1400	1.8	105	303L3	—	BE100LA4	BX100LA4	ME3LA4	MX3LA4	18900	21600	36900	43700	10000	272		
13.7	1400	2.5	105	304L3	—	BE100LA4	BX100LA4	ME3LA4	MX3LA4	18900	21600	36900	43700	10000	284		
14.7	1300	1.8	97.0	—	304R3	BE100LA4	BX100LA4	ME3LA4	MX3LA4	18500	21100	36000	42700	9790	286		
15.6	1230	1.5	91.5	—	303R3	BE100LA4	BX100LA4	ME3LA4	MX3LA4	18100	20700	35400	42000	9600	274		
15.6	1230	2.9	91.5	—	305R3	BE100LA4	BX100LA4	ME3LA4	MX3LA4	18100	20700	35400	42000	9600	298		
15.9	1210	1.9	90.2	303L3	—	BE100LA4	BX100LA4	ME3LA4	MX3LA4	18000	20600	35300	41800	9550	272		
15.9	1210	2.8	90.2	304L3	—	BE100LA4	BX100LA4	ME3LA4	MX3LA4	18000	20600	35300	41800	9550	284		
16.0	1160	2.9	89.4	—	304R4	BE100LA4	BX100LA4	ME3LA4	MX3LA4	18000	20500	35200	41700	9520	286		
16.7	1150	1.5	85.6	301L3	—	BE100LA4	BX100LA4	ME3LA4	MX3LA4	5480	5480	18400	20100	3130	262		
16.8	1140	1.1	85.2	—	301R3	BE100LA4	BX100LA4	ME3LA4	MX3LA4	5470	5470	18400	20100	3120	264		
18.2	1060	1.5	78.7	—	301R3	BE100LA4	BX100LA4	ME3LA4	MX3LA4	5330	5330	18000	19600	3040	264		
18.2	1060	2.1	78.7	—	303R3	BE100LA4	BX100LA4	ME3LA4	MX3LA4	17200	19700	33900	40100	9130	274		
18.2	1060	2.7	78.7	—	304R3	BE100LA4	BX100LA4	ME3LA4	MX3LA4	17200	19700	33900	40100	9130	286		

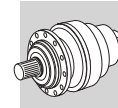

$P_1 = 2.2 \text{ kW}$

n_2 min ⁻¹	M_2 Nm	S	i	[Icons]		IE2		IE3		R _{n2} [N]					[Icon]
				IE2	IE3	IE2	IE3	MC	MZ	HC/PC	HZ/PZ	FZ			
18.5	1040	1.6	77.5	301L3	—	BE100LA4	BX100LA4	ME3LA4	MX3LA4	5300	5300	17900	19600	3030	262
18.5	1040	2.4	77.2	303L3	—	BE100LA4	BX100LA4	ME3LA4	MX3LA4	17100	19500	33700	39900	9070	272
19.5	980	1.9	73.3	—	303R3	BE100LA4	BX100LA4	ME3LA4	MX3LA4	16800	19200	33100	39300	8920	274
19.8	970	2.3	72.3	303L3	—	BE100LA4	BX100LA4	ME3LA4	MX3LA4	16700	19100	33000	39100	8870	272
20.5	940	1.4	69.9	301L3	—	BE100LA4	BX100LA4	ME3LA4	MX3LA4	5120	5120	17300	19000	2920	262
21.0	920	1.4	68.2	—	301R3	BE100LA4	BX100LA4	ME3LA4	MX3LA4	5080	5080	17200	18800	2900	264
22.1	900	1.3	64.8	301L2	—	BE100LA4	BX100LA4	ME3LA4	MX3LA4	4990	4990	17000	18500	2850	262
22.6	850	1.0	63.2	300L3	—	BE100LA4	BX100LA4	ME3LA4	MX3LA4	4950	4950	16800	19600	2830	252
22.6	850	1.9	63.2	301L3	—	BE100LA4	BX100LA4	ME3LA4	MX3LA4	4950	4950	16800	18400	2830	262
22.7	840	1.0	62.9	—	300R3	BE100LA4	BX100LA4	ME3LA4	MX3LA4	4940	4940	16800	19500	2820	254
22.7	840	2.0	62.9	—	301R3	BE100LA4	BX100LA4	ME3LA4	MX3LA4	4940	4940	16800	18400	2820	264
22.7	850	3.0	63.1	303L3	—	BE100LA4	BX100LA4	ME3LA4	MX3LA4	16000	18300	31700	37500	8480	272
22.7	850	2.6	63.1	—	303R3	BE100LA4	BX100LA4	ME3LA4	MX3LA4	16000	18300	31700	37500	8480	274
24.2	820	2.9	59.1	304L2	—	BE100LA4	BX100LA4	ME3LA4	MX3LA4	15600	17900	31100	36800	8300	284
25.6	770	2.4	55.8	303L2	—	BE100LA4	BX100LA4	ME3LA4	MX3LA4	15300	17500	30500	36200	8140	272
26.4	730	2.5	54.2	—	303R3	BE100LA4	BX100LA4	ME3LA4	MX3LA4	15200	17400	30300	35900	8060	274
27.5	720	0.9	51.9	300L2	—	BE100LA4	BX100LA4	ME3LA4	MX3LA4	4640	4640	15900	18400	2650	252
27.5	720	1.8	51.9	301L2	—	BE100LA4	BX100LA4	ME3LA4	MX3LA4	4640	4640	15900	17300	2650	262
27.7	690	1.2	51.6	300L3	—	BE100LA4	BX100LA4	ME3LA4	MX3LA4	4630	4630	15800	18400	2640	252
27.7	690	2.4	51.6	301L3	—	BE100LA4	BX100LA4	ME3LA4	MX3LA4	4630	4630	15800	17300	2640	262
28.4	680	1.3	50.4	—	300R3	BE100LA4	BX100LA4	ME3LA4	MX3LA4	4590	4590	15700	18300	2620	254
28.4	680	2.4	50.4	—	301R3	BE100LA4	BX100LA4	ME3LA4	MX3LA4	4590	4590	15700	17200	2620	264
32	620	2.9	44.6	303L2	—	BE100LA4	BX100LA4	ME3LA4	MX3LA4	14200	16300	28600	33800	7560	272
34	570	1.1	41.5	300L2	—	BE100LA4	BX100LA4	ME3LA4	MX3LA4	4300	4300	14800	17300	2460	252
34	570	2.3	41.5	301L2	—	BE100LA4	BX100LA4	ME3LA4	MX3LA4	4300	4300	14800	16200	2460	262
35	550	1.2	41.2	—	300R3	BE100LA4	BX100LA4	ME3LA4	MX3LA4	4290	4290	14800	17200	2450	254
35	550	2.4	41.2	—	301R3	BE100LA4	BX100LA4	ME3LA4	MX3LA4	4290	4290	14800	16200	2450	264
37	530	1.6	38.4	300L2	—	BE100LA4	BX100LA4	ME3LA4	MX3LA4	4190	4190	14500	16800	2390	252
37	530	2.9	38.4	301L2	—	BE100LA4	BX100LA4	ME3LA4	MX3LA4	4190	4190	14500	15800	2390	262
38	500	1.7	37.3	—	300R3	BE100LA4	BX100LA4	ME3LA4	MX3LA4	4150	4150	14400	16700	2370	254
43	460	1.4	33.3	300L2	—	BE100LA4	BX100LA4	ME3LA4	MX3LA4	4000	4000	13900	16100	2280	252
43	460	2.8	33.3	301L2	—	BE100LA4	BX100LA4	ME3LA4	MX3LA4	4000	4000	13900	15200	2280	262
47	420	2.0	30.7	300L2	—	BE100LA4	BX100LA4	ME3LA4	MX3LA4	3890	3890	13600	15800	2220	252
47	410	2.1	30.4	—	300R3	BE100LA4	BX100LA4	ME3LA4	MX3LA4	3880	3880	13500	15700	2220	254
58	340	2.4	24.6	300L2	—	BE100LA4	BX100LA4	ME3LA4	MX3LA4	3610	3610	12700	14700	2070	252
58	330	2.2	24.8	—	300R3	BE100LA4	BX100LA4	ME3LA4	MX3LA4	3630	3630	12700	14800	2070	254
58	340	2.5	24.8	—	303R2	BE100LA4	BX100LA4	ME3LA4	MX3LA4	11700	13400	23900	28400	6210	274
71	280	2.3	20.1	300L2	—	BE100LA4	BX100LA4	ME3LA4	MX3LA4	3380	3380	11900	13900	1930	252
78	260	1.4	18.5	—	300R2	BE100LA4	BX100LA4	ME3LA4	MX3LA4	3280	3280	11600	13500	1880	254
78	260	2.9	18.5	—	301R2	BE100LA4	BX100LA4	ME3LA4	MX3LA4	3280	3280	11600	12700	1880	264
97	200	2.5	14.8	—	300R2	BE100LA4	BX100LA4	ME3LA4	MX3LA4	3050	3050	10900	12600	1740	254
159	130	2.5	9.00	300L1	—	BE100LA4	BX100LA4	ME3LA4	MX3LA4	2590	2590	9380	10900	1480	252

$P_1 = 3 \text{ kW}$

n_2 min ⁻¹	M_2 Nm	S	i	[Icons]		IE2		IE3		R _{n2} [N]					[Icon]
				IE2	IE3	IE2	IE3	MC	MZ	HC/PC	HZ/PZ	FZ			
0.65	38700	1.0	2187	313ML4	—	BE100LB4	BX100LB4	—	—	—	—	190100	222700	80000	368
0.68	37100	1.0	2096	311ML4	—	BE100LB4	BX100LB4	—	—	—	—	130400	133100	65000	356
0.78	32200	1.8	1817	313ML4	—	BE100LB4	BX100LB4	—	—	—	—	185100	216900	80000	368
0.80	31300	1.3	1766	311ML4	—	BE100LB4	BX100LB4	—	—	—	—	127200	129800	65000	356
0.85	29700	1.2	1680	311ML4	—	BE100LB4	BX100LB4	—	—	—	—	126300	128900	65000	356
0.95	26600	2.1	1502	313ML4	—	BE100LB4	BX100LB4	—	—	—	—	180100	211100	80000	368
0.99	25500	0.9	1438	310ML4	—	BE100LB4	BX100LB4	—	—	—	—	98300	124700	65000	344
1.0	25100	1.6	1415	311ML4	—	BE100LB4	BX100LB4	—	—	—	—	123300	125800	64900	356
1.0	24700	2.1	1394	313ML4	—	BE100LB4	BX100LB4	—	—	—	—	178200	208900	79500	368
1.1	22300	1.1	1259	310ML4	—	BE100LB4	BX100LB4	—	—	—	—	96500	122300	62400	344
1.1	22400	2.5	1266	313ML4	—	BE100LB4	BX100LB4	—	—	—	—	175800	206000	77000	368
1.2	20600	1.4	1164	310ML4	—	BE100LB4	BX100LB4	—	—	—	—	95400	121000	60800	344
1.2	21800	2.1	1230	311ML4	—	BE100LB4	BX100LB4	—	—	—	—	120800	123300	62000	356
1.3	18700	2.4	1058	311ML4	—	BE100LB4	BX100LB4	—	—	—	—	118300	120700	58900	356



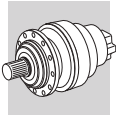

$P_1 = 3 \text{ kW}$

n_2 min ⁻¹	M_2 Nm	S	i	IE2		IE3		IE2		IE3		R _{n2} [N]					
				MC	MZ	HC/PC	HZ/PZ	FZ									
1.3	19800	2.5	1117	313ML4	—	BE100LB4	BX100LB4	—	—	—	—	172700	202400	73800	368		
1.4	17700	1.0	999	309L4	—	BE100LB4	BX100LB4	—	—	—	—	82600	106300	32000	334		
1.4	17700	1.6	1002	310ML4	—	BE100LB4	BX100LB4	—	—	—	—	93400	118400	57900	344		
1.4	17500	2.6	986	311ML4	—	BE100LB4	BX100LB4	—	—	—	—	117100	119500	57600	356		
1.5	17200	1.9	974	310ML4	—	BE100LB4	BX100LB4	—	—	—	—	93000	117900	57300	344		
1.6	16000	1.0	906	307L4	—	BE100LB4	BX100LB4	ME3LB4	MX3LB4	35400	44300	79700	104800	38700	320		
1.6	16000	1.1	906	309L4	—	BE100LB4	BX100LB4	—	—	—	—	81400	104800	31000	334		
1.6	15900	1.4	898	—	310MR4	BE100LB4	BX100LB4	—	—	—	—	91900	116600	55800	346		
1.8	14200	0.9	801	307L4	—	BE100LB4	BX100LB4	ME3LB4	MX3LB4	34800	43500	78300	103000	37200	320		
1.8	14200	1.3	801	309L4	—	BE100LB4	BX100LB4	—	—	—	—	80000	103000	29700	334		
1.8	14100	1.9	798	310ML4	—	BE100LB4	BX100LB4	—	—	—	—	90400	114600	53600	344		
1.8	13800	2.6	778	—	313MR4	BE100LB4	BX100LB4	—	—	—	—	164000	192200	65500	370		
1.9	13400	1.9	757	—	310MR4	BE100LB4	BX100LB4	—	—	—	—	89700	113800	52700	346		
1.9	13200	2.5	746	—	311MR4	BE100LB4	BX100LB4	—	—	—	—	112500	114800	52500	358		
2.0	12800	1.2	722	307L4	—	BE100LB4	BX100LB4	ME3LB4	MX3LB4	34300	42800	77100	101500	35900	320		
2.0	12800	1.7	722	309L4	—	BE100LB4	BX100LB4	—	—	—	—	78800	101500	28700	334		
2.0	12900	2.1	726	310ML4	—	BE100LB4	BX100LB4	—	—	—	—	89200	113100	52000	344		
2.1	12200	1.2	690	—	309R4	BE100LB4	BX100LB4	—	—	—	—	78300	100800	28300	332		
2.2	11600	1.1	654	307L4	—	BE100LB4	BX100LB4	ME3LB4	MX3LB4	33800	42200	76000	100000	34700	320		
2.2	11600	1.6	654	309L4	—	BE100LB4	BX100LB4	—	—	—	—	77700	100000	27800	334		
2.2	11300	2.3	637	310ML4	—	BE100LB4	BX100LB4	—	—	—	—	87500	111000	49700	344		
2.2	11300	1.8	639	—	310MR4	BE100LB4	BX100LB4	—	—	—	—	87600	111000	49800	346		
2.4	10300	1.2	581	—	307R4	BE100LB4	BX100LB4	—	—	33200	41500	74800	98400	33400	322		
2.4	10300	1.5	581	—	309R4	BE100LB4	BX100LB4	—	—	—	—	76400	98400	26700	332		
2.4	10400	2.5	590	310ML4	—	BE100LB4	BX100LB4	—	—	—	—	86600	109800	48500	344		
2.4	10400	1.9	590	—	310MR4	BE100LB4	BX100LB4	—	—	—	—	86600	109800	48500	346		
2.5	10200	1.5	579	307L4	—	BE100LB4	BX100LB4	ME3LB4	MX3LB4	33200	41500	74700	98300	33400	320		
2.5	10200	2.1	579	309L4	—	BE100LB4	BX100LB4	—	—	—	—	76400	98300	26700	334		
2.7	9160	2.8	517	—	310MR4	BE100LB4	BX100LB4	—	—	—	—	85000	107700	46400	346		
2.8	9020	1.0	509	306L4	—	BE100LB4	BX100LB4	ME3LB4	MX3LB4	27200	31000	62000	71500	24900	308		
2.8	9020	1.6	509	307L4	—	BE100LB4	BX100LB4	ME3LB4	MX3LB4	32600	40800	73400	96500	32000	320		
2.8	9020	1.6	509	309L4	—	BE100LB4	BX100LB4	—	—	—	—	75000	96500	25600	334		
2.8	8980	2.8	507	310ML4	—	BE100LB4	BX100LB4	—	—	—	—	84700	107400	46100	344		
2.9	8640	1.1	488	—	306R4	BE100LB4	BX100LB4	ME3LB4	MX3LB4	27000	30800	61600	71100	24500	310		
2.9	8680	1.1	490	—	307R4	BE100LB4	BX100LB4	—	—	32400	40500	73000	96000	31600	322		
2.9	8680	1.6	490	—	309R4	BE100LB4	BX100LB4	—	—	—	—	74600	96000	25300	332		
3.1	8230	1.5	465	307L4	—	BE100LB4	BX100LB4	ME3LB4	MX3LB4	32200	40200	72400	95300	31000	320		
3.1	8020	1.7	453	—	307R4	BE100LB4	BX100LB4	—	—	32100	40100	72200	94900	30700	322		
3.1	8230	2.2	465	309L4	—	BE100LB4	BX100LB4	—	—	—	—	74000	95300	24800	334		
3.1	8090	1.7	457	—	309R4	BE100LB4	BX100LB4	—	—	—	—	73800	95000	24700	332		
3.1	8040	2.4	454	—	310MR4	BE100LB4	BX100LB4	—	—	—	—	83400	105800	44500	346		
3.2	7870	1.3	444	306L4	—	BE100LB4	BX100LB4	ME3LB4	MX3LB4	26700	30400	60800	70100	23800	308		
3.4	7430	1.2	420	—	306R4	BE100LB4	BX100LB4	ME3LB4	MX3LB4	26400	30100	60300	69600	23300	310		
3.4	7320	1.6	413	—	307R4	BE100LB4	BX100LB4	—	—	31700	39600	71200	93700	29800	322		
3.4	7320	2.5	413	—	309R4	BE100LB4	BX100LB4	—	—	—	—	72800	93700	23900	332		
3.5	7180	1.7	406	307L4	—	BE100LB4	BX100LB4	ME3LB4	MX3LB4	31600	39500	71000	93400	29600	320		
3.5	7180	2.5	406	309L4	—	BE100LB4	BX100LB4	—	—	—	—	72600	93400	23700	334		
3.6	6920	1.0	391	306L4	—	BE100LB4	BX100LB4	ME3LB4	MX3LB4	26200	29800	59700	68900	22800	308		
3.6	6930	2.7	392	310ML4	—	BE100LB4	BX100LB4	—	—	—	—	81700	103500	42300	344		
3.7	6890	1.1	389	—	306R4	BE100LB4	BX100LB4	ME3LB4	MX3LB4	26100	29800	59600	68800	22700	310		
3.8	6630	2.2	374	—	309R4	BE100LB4	BX100LB4	—	—	—	—	71800	92400	23100	332		
3.9	6420	1.9	363	—	307R4	BE100LB4	BX100LB4	—	—	31100	38800	69900	92000	28600	322		
4.1	6180	2.4	349	307L4	—	BE100LB4	BX100LB4	ME3LB4	MX3LB4	30900	38600	69500	91500	28200	320		
4.2	6140	1.5	336	307L3	—	BE100LB4	BX100LB4	ME3LB4	MX3LB4	30700	38400	69200	91000	27800	320		
4.2	6140	2.2	336	309L3	—	BE100LB4	BX100LB4	—	—	—	—	70700	91000	22300	334		
4.3	5860	2.0	331	—	307R4	BE100LB4	BX100LB4	—	—	30700	38300	69000	90800	27700	322		
4.3	5860	3.0	331	—	309R4	BE100LB4	BX100LB4	—	—	—	—	70500	90800	22200	332		
4.4	5920	0.9	325	306L3	—	BE100LB4	BX100LB4	ME3LB4	MX3LB4	25500	29000	58100	67100	21400	308		
4.6	5520	1.4	312	—	306R4	BE100LB4	BX100LB4	ME3LB4	MX3LB4	25300	28900	57800	66700	21100	310		
4.7	5310	2.6	300	—	307R4	BE100LB4	BX100LB4	—	—	30200	37800	68000	89500	26800	322		
4.9	5130	1.0	290	—	305R4	BE100LB4	BX100LB4	ME3LB4	MX3LB4	21100	24100	40600	48100	14100	298		

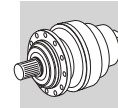

$P_1 = 3 \text{ kW}$

n ₂ min ⁻¹	M ₂ Nm	S	i	Motor Type		IE2		IE3		Rn ₂ [N]					Icon
				BE100LB4	BX100LB4	ME3LB4	MX3LB4	MC	MZ	HC/PC	HZ/PZ	FZ			
4.9	5260	1.0	288	306L3	—	BE100LB4	BX100LB4	ME3LB4	MX3LB4	25100	28600	57100	65900	20600	308
4.9	5120	1.6	289	—	306R4	BE100LB4	BX100LB4	ME3LB4	MX3LB4	25100	28600	57100	66000	20600	310
5.0	5170	2.2	284	307L3	—	BE100LB4	BX100LB4	ME3LB4	MX3LB4	30000	37500	67500	88800	26300	320
5.0	5040	2.2	284	—	307R4	BE100LB4	BX100LB4	—	—	30000	37500	67500	88800	26300	322
5.3	4900	1.1	268	306L3	—	BE100LB4	BX100LB4	ME3LB4	MX3LB4	25000	28500	57000	65800	20100	308
5.7	4400	1.9	249	—	306R4	BE100LB4	BX100LB4	ME3LB4	MX3LB4	25000	28500	57000	65800	19600	310
5.9	4370	2.0	239	307L3	—	BE100LB4	BX100LB4	ME3LB4	MX3LB4	30000	37500	67500	88800	24900	320
5.9	4370	3.0	239	309L3	—	BE100LB4	BX100LB4	—	—	—	—	69000	88800	19900	334
6.0	4350	1.9	238	306L3	—	BE100LB4	BX100LB4	ME3LB4	MX3LB4	25000	28500	57000	65800	19300	308
6.1	4110	2.7	232	—	307R4	BE100LB4	BX100LB4	—	—	30000	37500	67500	88800	24600	322
6.2	4080	1.9	230	—	306R4	BE100LB4	BX100LB4	ME3LB4	MX3LB4	25000	28500	57000	65800	19100	310
6.4	4020	1.2	220	305L3	—	BE100LB4	BX100LB4	ME3LB4	MX3LB4	21000	24000	40500	48000	12900	296
6.4	4050	1.6	222	306L3	—	BE100LB4	BX100LB4	ME3LB4	MX3LB4	25000	28500	57000	65800	18800	308
6.6	3790	1.0	214	—	304R4	BE100LB4	BX100LB4	ME3LB4	MX3LB4	21000	24000	40500	48000	12800	286
6.6	3790	1.4	214	—	305R4	BE100LB4	BX100LB4	ME3LB4	MX3LB4	21000	24000	40500	48000	12800	298
6.6	3780	2.6	214	—	306R4	BE100LB4	BX100LB4	ME3LB4	MX3LB4	25000	28500	57000	65800	18600	310
6.9	3740	2.2	205	306L3	—	BE100LB4	BX100LB4	ME3LB4	MX3LB4	25000	28500	57000	65800	18400	308
7.5	3470	1.0	190	305L3	—	BE100LB4	BX100LB4	ME3LB4	MX3LB4	21000	24000	40500	48000	12300	296
7.5	3460	1.9	190	306L3	—	BE100LB4	BX100LB4	ME3LB4	MX3LB4	25000	28500	57000	65800	17900	308
7.7	3270	1.1	185	—	304R4	BE100LB4	BX100LB4	ME3LB4	MX3LB4	21000	24000	40500	48000	12200	286
7.7	3270	1.4	185	—	305R4	BE100LB4	BX100LB4	ME3LB4	MX3LB4	21000	24000	40500	48000	12200	298
7.8	3200	2.9	181	—	306R4	BE100LB4	BX100LB4	ME3LB4	MX3LB4	25000	28500	57000	65800	17600	310
8.0	3240	1.4	178	305L3	—	BE100LB4	BX100LB4	ME3LB4	MX3LB4	21000	24000	40500	48000	12000	296
8.5	2970	2.5	168	—	306R4	BE100LB4	BX100LB4	ME3LB4	MX3LB4	25000	28500	57000	65800	17200	310
8.7	2990	1.5	164	305L3	—	BE100LB4	BX100LB4	ME3LB4	MX3LB4	21000	24000	40500	48000	11700	296
9.0	2800	1.0	158	—	303R4	BE100LB4	BX100LB4	ME3LB4	MX3LB4	21000	24000	40500	48000	11600	274
9.0	2800	1.3	158	—	304R4	BE100LB4	BX100LB4	ME3LB4	MX3LB4	21000	24000	40500	48000	11600	286
9.0	2800	1.9	158	—	305R4	BE100LB4	BX100LB4	ME3LB4	MX3LB4	21000	24000	40500	48000	11600	298
9.3	2780	1.3	152	305L3	—	BE100LB4	BX100LB4	ME3LB4	MX3LB4	21000	24000	40500	48000	11400	296
9.3	2770	2.7	152	306L3	—	BE100LB4	BX100LB4	ME3LB4	MX3LB4	25000	28500	57000	65800	16600	308
9.5	2730	1.3	150	304L3	—	BE100LB4	BX100LB4	ME3LB4	MX3LB4	21000	24000	40500	48000	11300	284
9.6	2620	1.3	148	—	304R4	BE100LB4	BX100LB4	ME3LB4	MX3LB4	21000	24000	40500	48000	11300	286
9.6	2620	1.7	148	—	305R4	BE100LB4	BX100LB4	ME3LB4	MX3LB4	21000	24000	40500	48000	11300	298
9.9	2630	2.1	144	—	306R3	BE100LB4	BX100LB4	ME3LB4	MX3LB4	25000	28500	57000	65800	16300	310
10.0	2580	1.0	141	303L3	—	BE100LB4	BX100LB4	ME3LB4	MX3LB4	21000	24000	40500	47900	11100	272
10.0	2580	1.4	141	304L3	—	BE100LB4	BX100LB4	ME3LB4	MX3LB4	21000	24000	40500	47900	11100	284
10.0	2580	2.0	141	305L3	—	BE100LB4	BX100LB4	ME3LB4	MX3LB4	21000	24000	40500	47900	11100	296
10.9	2380	1.5	130	304L3	—	BE100LB4	BX100LB4	ME3LB4	MX3LB4	20400	23300	39500	46800	10800	284
11.0	2290	1.2	129	—	303R4	BE100LB4	BX100LB4	ME3LB4	MX3LB4	20400	23300	39400	46700	10800	274
11.0	2290	1.5	129	—	304R4	BE100LB4	BX100LB4	ME3LB4	MX3LB4	20400	23300	39400	46700	10800	286
11.0	2290	2.3	129	—	305R4	BE100LB4	BX100LB4	ME3LB4	MX3LB4	20400	23300	39400	46700	10800	298
11.4	2270	1.6	124	305L3	—	BE100LB4	BX100LB4	ME3LB4	MX3LB4	20100	23000	38900	46100	10700	296
11.7	2210	1.1	121	—	304R3	BE100LB4	BX100LB4	ME3LB4	MX3LB4	19900	22800	38600	45800	10600	286
11.9	2180	3.0	119	—	306R3	BE100LB4	BX100LB4	ME3LB4	MX3LB4	23600	26900	54100	62400	15300	310
12.4	2090	1.7	114	—	305R3	BE100LB4	BX100LB4	ME3LB4	MX3LB4	19500	22300	38000	45000	10400	298
12.6	2060	1.7	113	305L3	—	BE100LB4	BX100LB4	ME3LB4	MX3LB4	19400	22200	37800	44800	10300	296
12.9	2020	1.7	111	304L3	—	BE100LB4	BX100LB4	ME3LB4	MX3LB4	19300	22100	37600	44500	10200	284
13.0	1940	1.7	109	—	304R4	BE100LB4	BX100LB4	ME3LB4	MX3LB4	19300	22000	37500	44400	10200	286
13.4	1870	0.9	106	—	301R4	BE100LB4	BX100LB4	—	—	5890	5890	19700	21500	3370	264
13.6	1910	1.4	105	303L3	—	BE100LB4	BX100LB4	ME3LB4	MX3LB4	19000	21700	36900	43800	10100	272
13.6	1910	1.8	105	304L3	—	BE100LB4	BX100LB4	ME3LB4	MX3LB4	19000	21700	36900	43800	10100	284
13.6	1910	2.7	105	305L3	—	BE100LB4	BX100LB4	ME3LB4	MX3LB4	19000	21700	36900	43800	10100	296
14.6	1770	1.3	97.0	—	304R3	BE100LB4	BX100LB4	ME3LB4	MX3LB4	18500	21100	36100	42800	9810	286
15.5	1670	1.1	91.5	—	303R3	BE100LB4	BX100LB4	ME3LB4	MX3LB4	18100	20700	35500	42100	9620	274
15.5	1670	2.1	91.5	—	305R3	BE100LB4	BX100LB4	ME3LB4	MX3LB4	18100	20700	35500	42100	9620	298
15.7	1650	1.4	90.2	303L3	—	BE100LB4	BX100LB4	ME3LB4	MX3LB4	18100	20600	35300	41900	9580	272
15.7	1650	2.0	90.2	304L3	—	BE100LB4	BX100LB4	ME3LB4	MX3LB4	18100	20600	35300	41900	9580	284
15.7	1650	2.6	90.2	305L3	—	BE100LB4	BX100LB4	ME3LB4	MX3LB4	18100	20600	35300	41900	9580	296
15.9	1580	2.1	89.4	—	304R4	BE100LB4	BX100LB4	ME3LB4	MX3LB4	18000	20600	35200	41800	9550	286
16.6	1560	1.1	85.6	301L3	—	BE100LB4	BX100LB4	ME3LB4	MX3LB4	5490	5490	18500	20200	3140	262
18.0	1440	1.5	78.7	—	303R3	BE100LB4	BX100LB4	ME3LB4	MX3LB4	17300	19700	33900	40200	9150	274

A

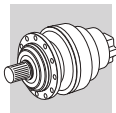

$P_1 = 3 \text{ kW}$

A

n ₂ min ⁻¹	M ₂ Nm	S	i	Motor Type		IE2		IE3		Rn ₂ [N]					Icon
				BE100LB4	BX100LB4	ME3LB4	MX3LB4	MC	MZ	HC/PC	HZ/PZ	FZ			
18.0	1440	2.0	78.7	—	304R3	BE100LB4	BX100LB4	ME3LB4	MX3LB4	17300	19700	33900	40200	9150	286
18.1	1440	1.1	78.7	—	301R3	BE100LB4	BX100LB4	ME3LB4	MX3LB4	5340	5340	18000	19700	3050	264
18.3	1410	1.2	77.5	301L3	—	BE100LB4	BX100LB4	ME3LB4	MX3LB4	5310	5310	17900	19600	3030	262
18.4	1410	1.8	77.2	303L3	—	BE100LB4	BX100LB4	ME3LB4	MX3LB4	17100	19600	33700	40000	9090	272
18.4	1410	2.5	77.2	304L3	—	BE100LB4	BX100LB4	ME3LB4	MX3LB4	17100	19600	33700	40000	9090	284
19.4	1340	1.4	73.3	—	303R3	BE100LB4	BX100LB4	ME3LB4	MX3LB4	16800	19300	33200	39400	8940	274
19.4	1340	2.7	73.3	—	305R3	BE100LB4	BX100LB4	ME3LB4	MX3LB4	16800	19300	33200	39400	8940	298
19.6	1320	1.7	72.3	303L3	—	BE100LB4	BX100LB4	ME3LB4	MX3LB4	16800	19200	33100	39200	8890	272
19.6	1320	2.5	72.3	304L3	—	BE100LB4	BX100LB4	ME3LB4	MX3LB4	16800	19200	33100	39200	8890	284
20.3	1280	1.0	69.9	301L3	—	BE100LB4	BX100LB4	ME3LB4	MX3LB4	5130	5130	17400	19000	2930	262
20.8	1250	1.0	68.2	—	301R3	BE100LB4	BX100LB4	ME3LB4	MX3LB4	5090	5090	17300	18900	2910	264
21.9	1220	0.9	64.8	301L2	—	BE100LB4	BX100LB4	ME3LB4	MX3LB4	5000	5000	17000	18600	2860	262
22.5	1150	1.4	63.2	301L3	—	BE100LB4	BX100LB4	ME3LB4	MX3LB4	4960	4960	16900	18400	2840	262
22.5	1150	2.2	63.1	303L3	—	BE100LB4	BX100LB4	ME3LB4	MX3LB4	16000	18300	31700	37600	8500	272
22.5	1150	1.9	63.1	—	303R3	BE100LB4	BX100LB4	ME3LB4	MX3LB4	16000	18300	31700	37600	8500	274
22.5	1150	2.5	63.1	—	304R3	BE100LB4	BX100LB4	ME3LB4	MX3LB4	16000	18300	31700	37600	8500	286
22.6	1150	1.4	62.9	—	301R3	BE100LB4	BX100LB4	ME3LB4	MX3LB4	4960	4960	16800	18400	2830	264
24.0	1110	2.1	59.1	304L2	—	BE100LB4	BX100LB4	ME3LB4	MX3LB4	15700	17900	31100	36900	8320	284
25.4	1050	1.7	55.8	303L2	—	BE100LB4	BX100LB4	ME3LB4	MX3LB4	15400	17600	30600	36300	8160	272
26.2	990	1.8	54.2	—	303R3	BE100LB4	BX100LB4	ME3LB4	MX3LB4	15200	17400	30300	36000	8080	274
26.6	970	2.2	53.4	303L3	—	BE100LB4	BX100LB4	ME3LB4	MX3LB4	15200	17300	30200	35800	8040	272
27.3	980	1.3	51.9	301L2	—	BE100LB4	BX100LB4	ME3LB4	MX3LB4	4650	4650	15900	17400	2660	262
27.5	940	1.7	51.6	301L3	—	BE100LB4	BX100LB4	ME3LB4	MX3LB4	4640	4640	15900	17300	2650	262
28.2	920	0.9	50.4	—	300R3	BE100LB4	BX100LB4	ME3LB4	MX3LB4	4600	4600	15800	18300	2630	254
28.2	920	1.8	50.4	—	301R3	BE100LB4	BX100LB4	ME3LB4	MX3LB4	4600	4600	15800	17200	2630	264
28.3	920	2.6	50.3	—	303R3	BE100LB4	BX100LB4	ME3LB4	MX3LB4	14900	17000	29700	35200	7880	274
30	850	2.5	46.6	—	303R3	BE100LB4	BX100LB4	ME3LB4	MX3LB4	14500	16600	29000	34400	7680	274
30	890	2.7	47.3	304L2	—	BE100LB4	BX100LB4	ME3LB4	MX3LB4	14600	16600	29100	34500	7720	284
32	840	2.2	44.6	303L2	—	BE100LB4	BX100LB4	ME3LB4	MX3LB4	14300	16300	28600	33900	7570	272
33	780	2.7	42.6	—	303R3	BE100LB4	BX100LB4	ME3LB4	MX3LB4	14100	16100	28200	33400	7460	274
34	780	1.7	41.5	301L2	—	BE100LB4	BX100LB4	ME3LB4	MX3LB4	4310	4310	14900	16300	2460	262
35	750	1.7	41.2	—	301R3	BE100LB4	BX100LB4	ME3LB4	MX3LB4	4300	4300	14800	16200	2460	264
37	720	1.2	38.4	300L2	—	BE100LB4	BX100LB4	ME3LB4	MX3LB4	4200	4200	14500	16900	2400	252
37	720	2.1	38.4	301L2	—	BE100LB4	BX100LB4	ME3LB4	MX3LB4	4200	4200	14500	15900	2400	262
37	720	3.0	38.4	303L2	—	BE100LB4	BX100LB4	ME3LB4	MX3LB4	13600	15500	27400	32400	7200	272
38	680	1.2	37.3	—	300R3	BE100LB4	BX100LB4	ME3LB4	MX3LB4	4160	4160	14400	16700	2380	254
38	680	2.4	37.3	—	301R3	BE100LB4	BX100LB4	ME3LB4	MX3LB4	4160	4160	14400	15700	2380	264
40	670	2.7	35.8	303L2	—	BE100LB4	BX100LB4	ME3LB4	MX3LB4	13300	15200	26800	31700	7040	272
43	630	1.0	33.3	300L2	—	BE100LB4	BX100LB4	ME3LB4	MX3LB4	4010	4010	13900	16200	2290	252
43	630	2.1	33.3	301L2	—	BE100LB4	BX100LB4	ME3LB4	MX3LB4	4010	4010	13900	15200	2290	262
46	580	1.5	30.7	300L2	—	BE100LB4	BX100LB4	ME3LB4	MX3LB4	3900	3900	13600	15800	2230	252
46	580	2.7	30.7	301L2	—	BE100LB4	BX100LB4	ME3LB4	MX3LB4	3900	3900	13600	14800	2230	262
47	560	1.5	30.4	—	300R3	BE100LB4	BX100LB4	ME3LB4	MX3LB4	3890	3890	13500	15700	2220	254
47	560	2.9	30.4	—	301R3	BE100LB4	BX100LB4	ME3LB4	MX3LB4	3890	3890	13500	14800	2220	264
57	450	1.6	24.8	—	300R3	BE100LB4	BX100LB4	ME3LB4	MX3LB4	3630	3630	12700	14800	2080	254
57	470	1.8	24.8	—	303R2	BE100LB4	BX100LB4	ME3LB4	MX3LB4	11700	13400	24000	28400	6220	274
58	460	1.8	24.6	300L2	—	BE100LB4	BX100LB4	ME3LB4	MX3LB4	3620	3620	12700	14800	2070	252
71	380	1.7	20.1	300L2	—	BE100LB4	BX100LB4	ME3LB4	MX3LB4	3390	3390	12000	13900	1930	252
77	350	1.1	18.5	—	300R2	BE100LB4	BX100LB4	ME3LB4	MX3LB4	3290	3290	11700	13600	1880	254
77	350	2.1	18.5	—	301R2	BE100LB4	BX100LB4	ME3LB4	MX3LB4	3290	3290	11700	12700	1880	264
78	340	2.2	18.2	300L2	—	BE100LB4	BX100LB4	ME3LB4	MX3LB4	3280	3280	11600	13500	1870	252
96	280	2.6	14.8	300L2	—	BE100LB4	BX100LB4	ME3LB4	MX3LB4	3060	3060	10900	12700	1750	252
96	280	1.8	14.8	—	300R2	BE100LB4	BX100LB4	ME3LB4	MX3LB4	3060	3060	10900	12700	1750	254
120	220	2.7	11.8	—	300R2	BE100LB4	BX100LB4	ME3LB4	MX3LB4	2840	2840	10200	11900	1620	254
158	170	1.8	9.00	300L1	—	BE100LB4	BX100LB4	ME3LB4	MX3LB4	2590	2590	9400	10900	1480	252
197	140	3.0	7.20	300L1	—	BE100LB4	BX100LB4	ME3LB4	MX3LB4	2410	2410	8790	10200	1370	252

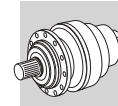

$P_1 = 4 \text{ kW}$

n_2 min ⁻¹	M_2 Nm	S	i			Rn ₂ [N]				MC	MZ	HC/PC	HZ/PZ	FZ	
						IE2	IE3	IE2	IE3						
0.79	43400	1.3	1817	313ML4	—	BE112M4	BX112M4	—	—	—	—	184700	216500	80000	368
0.82	42200	1.0	1766	311ML4	—	BE112M4	BX112M4	—	—	—	—	127000	129600	65000	356
0.86	40200	0.9	1680	311ML4	—	BE112M4	BX112M4	—	—	—	—	126100	128700	65000	356
0.96	35900	1.6	1502	313ML4	—	BE112M4	BX112M4	—	—	—	—	179800	210700	80000	368
1.0	33800	1.2	1415	311ML4	—	BE112M4	BX112M4	—	—	—	—	123000	125500	64600	356
1.0	33300	1.5	1394	313ML4	—	BE112M4	BX112M4	—	—	—	—	177900	208400	79100	368
1.1	30300	1.8	1266	313ML4	—	BE112M4	BX112M4	—	—	—	—	175400	205600	76600	368
1.2	27800	1.0	1164	310ML4	—	BE112M4	BX112M4	—	—	—	—	95200	120700	60600	344
1.2	29400	1.6	1230	311ML4	—	BE112M4	BX112M4	—	—	—	—	120600	123100	61700	356
1.3	26700	1.9	1117	313ML4	—	BE112M4	BX112M4	—	—	—	—	172300	201900	73500	368
1.4	23900	1.2	1002	310ML4	—	BE112M4	BX112M4	—	—	—	—	93200	118200	57600	344
1.4	25300	1.8	1058	311ML4	—	BE112M4	BX112M4	—	—	—	—	118000	120400	58700	356
1.4	24200	2.2	1014	313ML4	—	BE112M4	BX112M4	—	—	—	—	170000	199200	71200	368
1.5	23300	1.4	974	310ML4	—	BE112M4	BX112M4	—	—	—	—	92800	117700	57100	344
1.5	23600	1.9	986	311ML4	—	BE112M4	BX112M4	—	—	—	—	116800	119200	57300	356
1.6	21500	1.0	898	—	310MR4	BE112M4	BX112M4	—	—	—	—	91800	116300	55500	346
1.6	21300	2.5	889	313ML4	—	BE112M4	BX112M4	—	—	—	—	166800	195500	68100	368
1.7	19700	2.2	825	311ML4	—	BE112M4	BX112M4	—	—	—	—	113900	116200	54000	356
1.8	19100	0.9	801	309L4	—	BE112M4	BX112M4	—	—	—	—	79900	102800	29600	334
1.8	19100	1.4	798	310ML4	—	BE112M4	BX112M4	—	—	—	—	90200	114400	53400	344
1.8	18900	2.6	790	313ML4	—	BE112M4	BX112M4	—	—	—	—	164000	192200	65500	368
1.9	18100	1.4	757	—	310MR4	BE112M4	BX112M4	—	—	—	—	89500	113500	52500	346
1.9	17800	1.8	746	—	311MR4	BE112M4	BX112M4	—	—	—	—	112300	114600	52200	358
1.9	18600	1.9	778	—	313MR4	BE112M4	BX112M4	—	—	—	—	163700	191800	65200	370
2.0	17300	1.2	722	309L4	—	BE112M4	BX112M4	—	—	—	—	78700	101300	28600	334
2.0	17300	1.5	726	310ML4	—	BE112M4	BX112M4	—	—	—	—	89000	112900	51700	344
2.1	16500	0.9	690	—	309R4	BE112M4	BX112M4	—	—	—	—	78200	100600	28200	332
2.2	15600	1.2	654	309L4	—	BE112M4	BX112M4	—	—	—	—	77600	99800	27700	334
2.3	15200	1.7	637	310ML4	—	BE112M4	BX112M4	—	—	—	—	87400	110800	49500	344
2.3	15300	1.4	639	—	310MR4	BE112M4	BX112M4	—	—	—	—	87400	110800	49600	346
2.3	15000	2.8	627	311ML4	—	BE112M4	BX112M4	—	—	—	—	109500	111700	49300	356
2.3	15000	2.7	629	—	311MR4	BE112M4	BX112M4	—	—	—	—	109600	111800	49300	358
2.4	14100	1.8	590	310ML4	—	BE112M4	BX112M4	—	—	—	—	86400	109600	48300	344
2.4	14100	1.4	590	—	310MR4	BE112M4	BX112M4	—	—	—	—	86400	109600	48300	346
2.5	13800	1.1	579	307L4	—	BE112M4	BX112M4	ME4SA4	MX4SA4	33100	41400	74600	98100	33200	320
2.5	13900	0.9	581	—	307R4	BE112M4	BX112M4	—	—	33200	41500	74600	98200	33300	322
2.5	13800	1.5	579	309L4	—	BE112M4	BX112M4	—	—	0	0	76200	98100	26600	334
2.5	13900	1.1	581	—	309R4	BE112M4	BX112M4	—	—	0	0	76300	98200	26600	332
2.8	12200	1.2	509	307L4	—	BE112M4	BX112M4	ME4SA4	MX4SA4	32500	40700	73200	96300	31800	320
2.8	12200	1.2	509	309L4	—	BE112M4	BX112M4	—	—	—	—	74900	96300	25500	334
2.8	12100	2.1	507	310ML4	—	BE112M4	BX112M4	—	—	—	—	84600	107200	45900	344
2.8	12400	2.0	517	—	310MR4	BE112M4	BX112M4	—	—	—	—	84800	107500	46200	346
2.9	11700	1.2	490	—	309R4	BE112M4	BX112M4	—	—	—	—	74500	95800	25100	332
2.9	11700	2.7	490	—	311MR4	BE112M4	BX112M4	—	—	—	—	105700	107900	45400	358
3.1	11100	1.1	465	307L4	—	BE112M4	BX112M4	ME4SA4	MX4SA4	32100	40200	72300	95100	30900	320
3.1	11100	1.7	465	309L4	—	BE112M4	BX112M4	—	—	—	—	73900	95100	24700	334
3.2	10600	0.9	444	306L4	—	BE112M4	BX112M4	ME4SA4	MX4SA4	26600	30300	60600	70000	23600	308
3.2	10800	1.2	453	—	307R4	BE112M4	BX112M4	—	—	32000	40000	72000	94700	30600	322
3.2	10900	1.3	457	—	309R4	BE112M4	BX112M4	—	—	—	—	73700	94900	24600	332
3.2	10800	2.7	453	310ML4	—	BE112M4	BX112M4	—	—	—	—	83200	105500	44200	344
3.2	10900	1.8	454	—	310MR4	BE112M4	BX112M4	—	—	—	—	83200	105500	44200	346
3.5	9880	1.2	413	—	307R4	BE112M4	BX112M4	—	—	31600	39500	71100	93500	29700	322
3.5	9880	1.8	413	—	309R4	BE112M4	BX112M4	—	—	—	—	72700	93500	23700	332
3.6	9690	1.2	406	307L4	—	BE112M4	BX112M4	ME4SA4	MX4SA4	31500	39400	70900	93200	29500	320
3.6	9690	1.9	406	309L4	—	BE112M4	BX112M4	—	—	—	—	72500	93200	23600	334
3.7	9360	2.0	392	310ML4	—	BE112M4	BX112M4	—	—	—	—	81500	103300	42100	344
3.8	8950	1.6	374	—	309R4	BE112M4	BX112M4	—	—	—	—	71600	92200	23000	332
3.8	9150	2.6	383	—	310MR4	BE112M4	BX112M4	—	—	—	—	81200	103000	41800	346
4.0	8670	1.4	363	—	307R4	BE112M4	BX112M4	—	—	31000	38800	69800	91800	28400	322
4.1	8340	1.8	349	307L4	—	BE112M4	BX112M4	ME4SA4	MX4SA4	30800	38500	69400	91300	28100	320
4.1	8340	2.5	349	309L4	—	BE112M4	BX112M4	—	—	—	—	70900	91300	22400	334
4.3	8290	1.1	336	307L3	—	BE112M4	BX112M4	ME4SA4	MX4SA4	30700	38300	69000	90800	27700	320
4.3	7920	1.5	331	—	307R4	BE112M4	BX112M4	—	—	30600	38300	68900	90600	27600	322
4.3	8290	1.6	336	309L3	—	BE112M4	BX112M4	—	—	—	—	70600	90800	22200	334
4.3	7920	2.2	331	—	309R4	BE112M4	BX112M4	—	—	—	—	70400	90600	22100	332
4.6	7450	1.0	312	—	306R4	BE112M4	BX112M4	ME4SA4	MX4SA4	25300	28800	57600	66500	21000	310
4.8	7170	2.0	300	—	307R4	BE112M4	BX112M4	—	—	30200	37700	67900	89300	26700	322
5.0	6910	1.2	289	—	306R4	BE112M4	BX112M4	ME4SA4	MX4SA4	25000	28500	57000	65800	20500	310



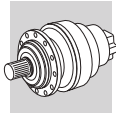

$P_1 = 4 \text{ kW}$

n ₂ min ⁻¹	M ₂ Nm	S	i	[Image]	[Image]	[Image]				Rn ₂ [N]					[Icon]
						IE2	IE3	IE2	IE3	MC	MZ	HC/PC	HZ/PZ	FZ	
5.1	6990	1.6	284	307L3	—	BE112M4	BX112M4	ME4SA4	MX4SA4	30000	37500	67500	88800	26200	320
5.1	6800	1.7	284	—	307R4	BE112M4	BX112M4	—	—	30000	37500	67500	88800	26200	322
5.1	6990	2.3	284	309L3	—	BE112M4	BX112M4	—	—	—	—	69000	88800	20900	334
5.1	6800	2.5	284	—	309R4	BE112M4	BX112M4	—	—	—	—	69000	88800	21000	332
5.6	6170	2.4	258	—	307R4	BE112M4	BX112M4	—	—	30000	37500	67500	88800	25400	322
5.6	6170	2.8	258	—	309R4	BE112M4	BX112M4	—	—	—	—	69000	88800	20300	332
5.8	5940	1.4	249	—	306R4	BE112M4	BX112M4	ME4SA4	MX4SA4	25000	28500	57000	65800	19500	310
6.0	5870	1.4	238	306L3	—	BE112M4	BX112M4	ME4SA4	MX4SA4	25000	28500	57000	65800	19200	308
6.0	5900	1.5	239	307L3	—	BE112M4	BX112M4	ME4SA4	MX4SA4	30000	37500	67500	88800	24700	320
6.0	5900	2.2	239	309L3	—	BE112M4	BX112M4	—	—	—	—	69000	88800	19800	334
6.2	5550	2.0	232	—	307R4	BE112M4	BX112M4	—	—	30000	37500	67500	88800	24500	322
6.3	5500	1.4	230	—	306R4	BE112M4	BX112M4	ME4SA4	MX4SA4	25000	28500	57000	65800	19000	310
6.5	5460	1.2	222	306L3	—	BE112M4	BX112M4	ME4SA4	MX4SA4	25000	28500	57000	65800	18800	308
6.5	5440	2.3	221	307L3	—	BE112M4	BX112M4	ME4SA4	MX4SA4	30000	37500	67500	88800	24100	320
6.5	5490	2.4	223	309L3	—	BE112M4	BX112M4	—	—	—	—	69000	88800	19300	334
6.7	5120	1.1	214	—	305R4	BE112M4	BX112M4	ME4SA4	MX4SA4	21000	24000	40500	48000	12700	298
6.7	5110	1.9	214	—	306R4	BE112M4	BX112M4	ME4SA4	MX4SA4	25000	28500	57000	65800	18500	310
7.0	5050	1.6	205	306L3	—	BE112M4	BX112M4	ME4SA4	MX4SA4	25000	28500	57000	65800	18300	308
7.0	4920	2.9	206	—	307R4	BE112M4	BX112M4	—	—	30000	37500	67500	88800	23500	322
7.1	4970	2.2	202	307L3	—	BE112M4	BX112M4	ME4SA4	MX4SA4	30000	37500	67500	88800	23400	320
7.6	4680	1.4	190	306L3	—	BE112M4	BX112M4	ME4SA4	MX4SA4	25000	28500	57000	65800	17800	308
7.8	4420	1.0	185	—	305R4	BE112M4	BX112M4	ME4SA4	MX4SA4	21000	24000	40500	48000	12100	298
8.0	4330	2.2	181	—	306R4	BE112M4	BX112M4	ME4SA4	MX4SA4	25000	28500	57000	65800	17500	310
8.1	4370	1.0	178	305L3	—	BE112M4	BX112M4	ME4SA4	MX4SA4	21000	24000	40500	48000	11900	296
8.1	4360	2.8	177	307L3	—	BE112M4	BX112M4	ME4SA4	MX4SA4	30000	37500	67500	88800	22400	320
8.6	4010	1.9	168	—	306R4	BE112M4	BX112M4	ME4SA4	MX4SA4	25000	28500	57000	65800	17100	310
8.7	3950	2.8	165	—	307R4	BE112M4	BX112M4	—	—	30000	37500	67500	88800	21900	322
8.8	4030	1.1	164	305L3	—	BE112M4	BX112M4	ME4SA4	MX4SA4	21000	24000	40500	48000	11600	296
8.9	3980	2.7	162	307L3	—	BE112M4	BX112M4	ME4SA4	MX4SA4	30000	37500	67500	88800	21700	320
9.1	3780	0.9	158	—	304R4	BE112M4	BX112M4	ME4SA4	MX4SA4	21000	24000	40500	48000	11500	286
9.1	3780	1.4	158	—	305R4	BE112M4	BX112M4	ME4SA4	MX4SA4	21000	24000	40500	48000	11500	298
9.1	3770	2.6	158	—	306R4	BE112M4	BX112M4	ME4SA4	MX4SA4	25000	28500	57000	65800	16800	310
9.4	3760	1.0	152	305L3	—	BE112M4	BX112M4	ME4SA4	MX4SA4	21000	24000	40500	48000	11400	296
9.5	3750	2.0	152	306L3	—	BE112M4	BX112M4	ME4SA4	MX4SA4	25000	28500	57000	65800	16500	308
9.6	3680	0.9	150	304L3	—	BE112M4	BX112M4	ME4SA4	MX4SA4	21000	24000	40500	48000	11300	284
9.7	3540	1.0	148	—	304R4	BE112M4	BX112M4	ME4SA4	MX4SA4	21000	24000	40500	48000	11200	286
9.7	3540	1.3	148	—	305R4	BE112M4	BX112M4	ME4SA4	MX4SA4	21000	24000	40500	48000	11200	298
10.0	3550	1.5	144	—	306R3	BE112M4	BX112M4	ME4SA4	MX4SA4	25000	28500	57000	65800	16300	310
10.2	3490	1.0	141	304L3	—	BE112M4	BX112M4	ME4SA4	MX4SA4	20900	23900	40300	47700	11100	284
10.2	3490	1.5	141	305L3	—	BE112M4	BX112M4	ME4SA4	MX4SA4	20900	23900	40300	47700	11100	296
10.2	3470	2.3	141	306L3	—	BE112M4	BX112M4	ME4SA4	MX4SA4	24800	28300	56600	65400	16100	308
11.0	3210	1.1	130	304L3	—	BE112M4	BX112M4	ME4SA4	MX4SA4	20300	23200	39300	46600	10800	284
11.1	3090	1.1	129	—	304R4	BE112M4	BX112M4	ME4SA4	MX4SA4	20300	23200	39200	46500	10700	286
11.1	3090	1.7	129	—	305R4	BE112M4	BX112M4	ME4SA4	MX4SA4	20300	23200	39200	46500	10700	298
11.6	3070	1.2	124	305L3	—	BE112M4	BX112M4	ME4SA4	MX4SA4	20000	22900	38800	45900	10600	296
11.9	2990	2.6	121	306L3	—	BE112M4	BX112M4	ME4SA4	MX4SA4	23600	26900	54100	62500	15300	308
12.0	2950	2.9	120	—	307R3	BE112M4	BX112M4	ME4SA4	MX4SA4	28200	35300	63900	84000	19600	322
12.1	2940	2.2	119	—	306R3	BE112M4	BX112M4	ME4SA4	MX4SA4	23500	26800	53900	62200	15300	310
12.6	2820	1.3	114	—	305R3	BE112M4	BX112M4	ME4SA4	MX4SA4	19400	22200	37800	44800	10300	298
12.8	2780	1.3	113	305L3	—	BE112M4	BX112M4	ME4SA4	MX4SA4	19400	22100	37600	44600	10300	296
12.8	2770	2.7	112	306L3	—	BE112M4	BX112M4	ME4SA4	MX4SA4	23000	26200	52900	61100	15000	308
13.0	2720	1.2	111	304L3	—	BE112M4	BX112M4	ME4SA4	MX4SA4	19200	22000	37400	44300	10200	284
13.2	2620	1.3	109	—	304R4	BE112M4	BX112M4	ME4SA4	MX4SA4	19200	21900	37300	44200	10200	286
13.8	2580	1.0	105	303L3	—	BE112M4	BX112M4	ME4SA4	MX4SA4	18900	21600	36800	43600	10000	272
13.8	2580	1.4	105	304L3	—	BE112M4	BX112M4	ME4SA4	MX4SA4	18900	21600	36800	43600	10000	284
13.8	2580	2.0	105	305L3	—	BE112M4	BX112M4	ME4SA4	MX4SA4	18900	21600	36800	43600	10000	296
14.6	2430	2.7	98.5	—	306R3	BE112M4	BX112M4	ME4SA4	MX4SA4	22000	25100	50900	58700	14300	310
14.8	2390	1.0	97.0	—	304R3	BE112M4	BX112M4	ME4SA4	MX4SA4	18400	21000	36000	42600	9770	286
15.7	2260	1.6	91.5	—	305R3	BE112M4	BX112M4	ME4SA4	MX4SA4	18100	20600	35400	41900	9580	298
16.0	2220	1.0	90.2	303L3	—	BE112M4	BX112M4	ME4SA4	MX4SA4	18000	20500	35200	41700	9530	272
16.0	2220	1.5	90.2	304L3	—	BE112M4	BX112M4	ME4SA4	MX4SA4	18000	20500	35200	41700	9530	284
16.0	2220	1.9	90.2	305L3	—	BE112M4	BX112M4	ME4SA4	MX4SA4	18000	20500	35200	41700	9530	296
16.1	2140	1.6	89.4	—	304R4	BE112M4	BX112M4	ME4SA4	MX4SA4	17900	20500	35100	41600	9500	286
18.3	1940	1.1	78.7	—	303R3	BE112M4	BX112M4	ME4SA4	MX4SA4	17200	19600	33800	40000	9110	274
18.3	1940	1.5	78.7	—	304R3	BE112M4	BX112M4	ME4SA4	MX4SA4	17200	19600	33800	40000	9110	286
18.3	1940	2.2	78.7	—	305R3	BE112M4	BX112M4	ME4SA4	MX4SA4	17200	19600	33800	40000	9110	298
18.6	1900	1.3	77.2	303L3	—	BE112M4	BX112M4	ME4SA4	MX4SA4	17100	19500	33600	39800	9050	272
18.6	1900	1.8	77.2	304L3	—	BE112M4	BX112M4	ME4SA4	MX4SA4	17100	19500	33600	39800	9050	284

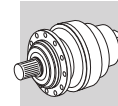

$P_1 = 4 \text{ kW}$

n ₂ min ⁻¹	M ₂ Nm	S	i	IE2		IE3		IE2		IE3		Rn ₂ [N]					📄
				MC	MZ	HC/PC	HZ/PZ	FZ									
18.6	1900	2.5	77.2	305L3	—	BE112M4	BX112M4	ME4SA4	MX4SA4	17100	19500	33600	39800	9050	296		
19.6	1810	1.0	73.3	—	303R3	BE112M4	BX112M4	ME4SA4	MX4SA4	16800	19200	33100	39200	8900	274		
19.6	1810	2.0	73.3	—	305R3	BE112M4	BX112M4	ME4SA4	MX4SA4	16800	19200	33100	39200	8900	298		
19.9	1780	1.3	72.3	303L3	—	BE112M4	BX112M4	ME4SA4	MX4SA4	16700	19100	32900	39000	8850	272		
19.9	1780	1.9	72.3	304L3	—	BE112M4	BX112M4	ME4SA4	MX4SA4	16700	19100	32900	39000	8850	284		
19.9	1780	2.3	72.3	305L3	—	BE112M4	BX112M4	ME4SA4	MX4SA4	16700	19100	32900	39000	8850	296		
22.8	1560	1.1	63.2	301L3	—	BE112M4	BX112M4	ME4SA4	MX4SA4	4940	4940	16800	18400	2820	262		
22.8	1550	1.6	63.1	303L3	—	BE112M4	BX112M4	ME4SA4	MX4SA4	15900	18200	31600	37500	8460	272		
22.8	1550	1.4	63.1	—	303R3	BE112M4	BX112M4	ME4SA4	MX4SA4	15900	18200	31600	37500	8460	274		
22.8	1550	2.2	63.1	304L3	—	BE112M4	BX112M4	ME4SA4	MX4SA4	15900	18200	31600	37500	8460	284		
22.8	1550	1.8	63.1	—	304R3	BE112M4	BX112M4	ME4SA4	MX4SA4	15900	18200	31600	37500	8460	286		
22.8	1550	2.8	63.1	—	305R3	BE112M4	BX112M4	ME4SA4	MX4SA4	15900	18200	31600	37500	8460	298		
22.9	1550	1.1	62.9	—	301R3	BE112M4	BX112M4	ME4SA4	MX4SA4	4930	4930	16800	18300	2820	264		
24.3	1500	1.6	59.1	304L2	—	BE112M4	BX112M4	ME4SA4	MX4SA4	15600	17800	31000	36800	8280	284		
25.8	1420	1.3	55.8	303L2	—	BE112M4	BX112M4	ME4SA4	MX4SA4	15300	17500	30500	36100	8120	272		
25.8	1420	2.5	55.8	305L2	—	BE112M4	BX112M4	ME4SA4	MX4SA4	15300	17500	30500	36100	8120	296		
26.6	1340	1.4	54.2	—	303R3	BE112M4	BX112M4	ME4SA4	MX4SA4	15200	17300	30200	35800	8040	274		
26.6	1340	2.7	54.2	—	305R3	BE112M4	BX112M4	ME4SA4	MX4SA4	15200	17300	30200	35800	8040	298		
27.0	1320	1.7	53.4	303L3	—	BE112M4	BX112M4	ME4SA4	MX4SA4	15100	17200	30100	35600	8000	272		
27.0	1320	2.5	53.4	304L3	—	BE112M4	BX112M4	ME4SA4	MX4SA4	15100	17200	30100	35600	8000	284		
27.7	1320	1.0	51.9	301L2	—	BE112M4	BX112M4	ME4SA4	MX4SA4	4630	4630	15800	17300	2640	262		
27.9	1270	1.3	51.6	301L3	—	BE112M4	BX112M4	ME4SA4	MX4SA4	4620	4620	15800	17300	2640	262		
28.6	1240	1.3	50.4	—	301R3	BE112M4	BX112M4	ME4SA4	MX4SA4	4580	4580	15700	17200	2620	264		
28.6	1240	1.9	50.3	—	303R3	BE112M4	BX112M4	ME4SA4	MX4SA4	14800	16900	29500	35000	7840	274		
28.6	1240	2.8	50.3	—	304R3	BE112M4	BX112M4	ME4SA4	MX4SA4	14800	16900	29500	35000	7840	286		
30	1200	2.0	47.3	304L2	—	BE112M4	BX112M4	ME4SA4	MX4SA4	14500	16600	29000	34400	7690	284		
31	1150	1.9	46.6	—	303R3	BE112M4	BX112M4	ME4SA4	MX4SA4	14400	16500	28900	34200	7650	274		
31	1150	2.5	46.6	—	304R3	BE112M4	BX112M4	ME4SA4	MX4SA4	14400	16500	28900	34200	7650	286		
32	1130	1.6	44.6	303L2	—	BE112M4	BX112M4	ME4SA4	MX4SA4	14200	16200	28500	33800	7540	272		
33	1070	3.0	43.6	304L3	—	BE112M4	BX112M4	ME4SA4	MX4SA4	14100	16100	28300	33500	7480	284		
34	1050	2.0	42.6	—	303R3	BE112M4	BX112M4	ME4SA4	MX4SA4	14000	16000	28100	33300	7420	274		
35	1060	1.2	41.5	301L2	—	BE112M4	BX112M4	ME4SA4	MX4SA4	4290	4290	14800	16200	2450	262		
35	1010	1.3	41.2	—	301R3	BE112M4	BX112M4	ME4SA4	MX4SA4	4280	4280	14800	16100	2450	264		
38	970	1.6	38.4	301L2	—	BE112M4	BX112M4	ME4SA4	MX4SA4	4180	4180	14500	15800	2390	262		
38	980	2.2	38.4	303L2	—	BE112M4	BX112M4	ME4SA4	MX4SA4	13500	15400	27200	32300	7170	272		
38	980	2.9	38.4	304L2	—	BE112M4	BX112M4	ME4SA4	MX4SA4	13500	15400	27200	32300	7170	284		
39	920	0.9	37.3	—	300R3	BE112M4	BX112M4	ME4SA4	MX4SA4	4140	4140	14300	16700	2370	254		
39	920	1.7	37.3	—	301R3	BE112M4	BX112M4	ME4SA4	MX4SA4	4140	4140	14300	15700	2370	264		
39	920	2.6	37.1	—	303R3	BE112M4	BX112M4	ME4SA4	MX4SA4	13400	15300	27000	32000	7090	274		
40	910	2.0	35.8	303L2	—	BE112M4	BX112M4	ME4SA4	MX4SA4	13200	15100	26700	31600	7000	272		
43	850	1.5	33.3	301L2	—	BE112M4	BX112M4	ME4SA4	MX4SA4	3990	3990	13900	15100	2280	262		
46	780	2.7	31.5	—	303R3	BE112M4	BX112M4	ME4SA4	MX4SA4	12600	14500	25700	30400	6710	274		
47	780	1.1	30.7	300L2	—	BE112M4	BX112M4	ME4SA4	MX4SA4	3880	3880	13500	15700	2220	252		
47	750	1.1	30.4	—	300R3	BE112M4	BX112M4	ME4SA4	MX4SA4	3870	3870	13500	15700	2210	254		
47	780	2.0	30.7	301L2	—	BE112M4	BX112M4	ME4SA4	MX4SA4	3880	3880	13500	14800	2220	262		
47	750	2.1	30.4	—	301R3	BE112M4	BX112M4	ME4SA4	MX4SA4	3870	3870	13500	14700	2210	264		
47	780	2.7	30.8	303L2	—	BE112M4	BX112M4	ME4SA4	MX4SA4	12600	14300	25500	30200	6660	272		
54	670	2.7	26.4	303L2	—	BE112M4	BX112M4	ME4SA4	MX4SA4	11900	13600	24400	28900	6330	272		
58	610	1.2	24.8	—	300R3	BE112M4	BX112M4	ME4SA4	MX4SA4	3620	3620	12700	14800	2070	254		
58	610	2.3	24.8	—	301R3	BE112M4	BX112M4	ME4SA4	MX4SA4	3620	3620	12700	13900	2070	264		
58	630	1.4	24.8	—	303R2	BE112M4	BX112M4	ME4SA4	MX4SA4	11700	13300	23900	28300	6200	274		
59	620	1.3	24.6	300L2	—	BE112M4	BX112M4	ME4SA4	MX4SA4	3610	3610	12700	14700	2060	252		
59	620	2.4	24.6	301L2	—	BE112M4	BX112M4	ME4SA4	MX4SA4	3610	3610	12700	13800	2060	262		
72	510	1.3	20.1	300L2	—	BE112M4	BX112M4	ME4SA4	MX4SA4	3370	3370	11900	13800	1930	252		
72	510	2.5	20.1	301L2	—	BE112M4	BX112M4	ME4SA4	MX4SA4	3370	3370	11900	13000	1930	262		
78	470	1.6	18.5	—	301R2	BE112M4	BX112M4	ME4SA4	MX4SA4	3280	3280	11600	12700	1870	264		
79	460	1.6	18.2	300L2	—	BE112M4	BX112M4	ME4SA4	MX4SA4	3260	3260	11600	13400	1860	252		
79	460	3.0	18.2	301L2	—	BE112M4	BX112M4	ME4SA4	MX4SA4	3260	3260	11600	12600	1860	262		
97	380	1.9	14.8	300L2	—	BE112M4	BX112M4	ME4SA4	MX4SA4	3050	3050	10900	12600	1740	252		
98	370	1.4	14.8	—	300R2	BE112M4	BX112M4	ME4SA4	MX4SA4	3040	3040	10900	12600	1740	254		
98	370	2.5	14.8	—	301R2	BE112M4	BX112M4	ME4SA4	MX4SA4	3040	3040	10900	11900	1740	264		
119	310	2.3	12.1	300L2	—	BE112M4	BX112M4	ME4SA4	MX4SA4	2850	2850	10200	11900	1630	252		
122	300	2.0	11.8	—	300R2	BE112M4	BX112M4	ME4SA4	MX4SA4	2830	2830	10200	11800	1610	254		
160	240	1.4	9.00	300L1	—	BE112M4	BX112M4	ME4SA4	MX4SA4	2580	2580	9360	10900	1470	252		
160	240	2.7	9.00	301L1	—	BE112M4	BX112M4	ME4SA4	MX4SA4	2580	2580	9360	10200	1470	262		
165	220	2.8	8.74	—	300R2	BE112M4	BX112M4	ME4SA4	MX4SA4	2550	2550	9280	10800	1460	254		
200	190	2.2	7.20	300L1	—	BE112M4	BX112M4	ME4SA4	MX4SA4	2390	2390	8750	10200	1370	252		

A

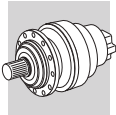

$P_1 = 5.5 \text{ kW}$

n_2 min ⁻¹	M_2 Nm	S	i	[Icons]		IE2		IE3		R _{n2} [N]					[Icon]
				[Icon]	[Icon]	[Icon]	[Icon]	IE2	IE3	MC	MZ	HC/PC	HZ/PZ	FZ	
0.77	60300	2.5	1893	317ML4	—	BE132S4	BX132SB4	—	—	—	—	410500	436100	150000	414
0.80	57900	1.0	1817	313ML4	—	BE132S4	BX132SB4	—	—	—	—	184400	216100	80000	368
0.81	57300	1.1	1796	314ML4	—	BE132S4	BX132SB4	—	—	—	—	171100	205200	90000	380
0.81	57500	1.4	1805	315ML4	—	BE132S4	BX132SB4	—	—	—	—	171200	205400	90000	392
0.94	49500	2.5	1553	316ML4	—	BE132S4	BX132SB4	—	—	—	—	256500	287700	150000	404
0.97	47900	1.2	1502	313ML4	—	BE132S4	BX132SB4	—	—	—	—	179400	210300	80000	368
0.98	47300	1.3	1485	314ML4	—	BE132S4	BX132SB4	—	—	—	—	166500	199700	90000	380
0.98	47600	1.7	1492	315ML4	—	BE132S4	BX132SB4	—	—	—	—	166600	199800	90000	392
1.0	45100	0.9	1415	311ML4	—	BE132S4	BX132SB4	—	—	—	—	122800	125300	64300	356
1.0	44400	1.1	1394	313ML4	—	BE132S4	BX132SB4	—	—	—	—	177500	208000	78800	368
1.1	40700	1.8	1277	314ML4	—	BE132S4	BX132SB4	—	—	—	—	163000	195500	86100	380
1.1	40900	2.2	1284	315ML4	—	BE132S4	BX132SB4	—	—	—	—	163100	195600	86200	392
1.1	41700	2.9	1308	316ML4	—	BE132S4	BX132SB4	—	—	—	—	250300	280700	144600	404
1.2	39200	1.2	1230	311ML4	—	BE132S4	BX132SB4	—	—	—	—	120400	122800	61400	356
1.2	40300	1.4	1266	313ML4	—	BE132S4	BX132SB4	—	—	—	—	175100	205200	76300	368
1.2	39400	3.0	1237	316ML4	—	BE132S4	BX132SB4	—	—	—	—	248300	278500	142000	404
1.3	35600	1.4	1117	313ML4	—	BE132S4	BX132SB4	—	—	—	—	172000	201600	73200	368
1.3	35000	2.0	1099	314ML4	—	BE132S4	BX132SB4	—	—	—	—	159500	191300	81900	380
1.3	35200	2.5	1104	315ML4	—	BE132S4	BX132SB4	—	—	—	—	159600	191400	82000	392
1.4	33700	1.3	1058	311ML4	—	BE132S4	BX132SB4	—	—	—	—	117800	120200	58400	356
1.4	32300	1.7	1014	313ML4	—	BE132S4	BX132SB4	—	—	—	—	169600	198800	70800	368
1.4	33100	2.3	1038	314ML4	—	BE132S4	BX132SB4	—	—	—	—	158200	189700	80300	380
1.4	33200	3.0	1043	315ML4	—	BE132S4	BX132SB4	—	—	—	—	158300	189900	80400	392
1.5	31000	1.0	974	310ML4	—	BE132S4	BX132SB4	—	—	—	—	92600	117500	56800	344
1.5	31400	1.4	986	311ML4	—	BE132S4	BX132SB4	—	—	—	—	116600	119000	57000	356
1.6	28300	1.8	889	313ML4	—	BE132S4	BX132SB4	—	—	—	—	166500	195100	67800	368
1.6	29500	2.4	926	314ML4	—	BE132S4	BX132SB4	—	—	—	—	155700	186700	77300	380
1.6	29700	3.0	930	315ML4	—	BE132S4	BX132SB4	—	—	—	—	155800	186800	77500	392
1.6	29000	2.5	909	—	315MR4	BE132S4	BX132SB4	—	—	—	—	155300	186200	76900	394
1.7	27300	2.7	858	314ML4	—	BE132S4	BX132SB4	—	—	—	—	154000	184600	75400	380
1.8	25400	1.1	798	310ML4	—	BE132S4	BX132SB4	—	—	—	—	90000	114200	53100	344
1.8	26300	1.7	825	311ML4	—	BE132S4	BX132SB4	—	—	—	—	113700	116000	53700	356
1.8	25200	2.0	790	313ML4	—	BE132S4	BX132SB4	—	—	—	—	163700	191800	65200	368
1.9	24100	1.0	757	—	310MR4	BE132S4	BX132SB4	—	—	—	—	89400	113300	52200	346
1.9	24800	1.4	778	—	313MR4	BE132S4	BX132SB4	—	—	—	—	163300	191400	64900	370
2.0	23000	0.9	722	309L4	—	BE132S4	BX132SB4	—	—	—	—	78500	101100	28500	334
2.0	23100	1.2	726	310ML4	—	BE132S4	BX132SB4	—	—	—	—	88800	112600	51500	344
2.0	23800	1.4	746	—	311MR4	BE132S4	BX132SB4	—	—	—	—	112100	114300	52000	358
2.1	22200	2.3	695	313ML4	—	BE132S4	BX132SB4	—	—	—	—	160700	188300	62500	368
2.3	20300	1.3	637	310ML4	—	BE132S4	BX132SB4	—	—	—	—	87200	110500	49300	344
2.3	20400	1.0	639	—	310MR4	BE132S4	BX132SB4	—	—	—	—	87200	110600	49300	346
2.3	20000	2.1	627	311ML4	—	BE132S4	BX132SB4	—	—	—	—	109300	111500	49000	356
2.3	20000	2.1	629	—	311MR4	BE132S4	BX132SB4	—	—	—	—	109300	111600	49100	358
2.3	20200	2.4	633	313ML4	—	BE132S4	BX132SB4	—	—	—	—	158600	185800	60500	368
2.3	20600	2.4	647	—	313MR4	BE132S4	BX132SB4	—	—	—	—	159100	186400	61000	370
2.4	19600	2.8	614	—	314MR4	BE132S4	BX132SB4	—	—	—	—	146800	176000	67400	382
2.5	18400	1.2	579	309L4	—	BE132S4	BX132SB4	—	—	—	—	76100	97900	26400	334
2.5	18800	1.4	590	310ML4	—	BE132S4	BX132SB4	—	—	—	—	86200	109300	48000	344
2.5	18800	1.0	590	—	310MR4	BE132S4	BX132SB4	—	—	—	—	86200	109300	48000	346
2.6	18100	2.3	568	311ML4	—	BE132S4	BX132SB4	—	—	—	—	107800	110000	47400	356
2.7	17000	2.8	535	—	313MR4	BE132S4	BX132SB4	—	—	—	—	154800	181400	57200	370
2.8	16500	1.5	517	—	310MR4	BE132S4	BX132SB4	—	—	—	—	84600	107300	46000	346
2.8	16600	2.4	520	—	311MR4	BE132S4	BX132SB4	—	—	—	—	106400	108600	46100	358
2.8	16400	2.9	514	313ML4	—	BE132S4	BX132SB4	—	—	—	—	153900	180400	56500	368
2.9	16200	1.5	507	310ML4	—	BE132S4	BX132SB4	—	—	—	—	84400	107000	45700	344
2.9	16300	2.8	512	311ML4	—	BE132S4	BX132SB4	—	—	—	—	106200	108400	45800	356
3.0	15600	2.1	490	—	311MR4	BE132S4	BX132SB4	—	—	—	—	105500	107700	45200	358
3.1	14800	1.2	465	309L4	—	BE132S4	BX132SB4	—	—	—	—	73700	94900	24600	334
3.2	14400	0.9	453	—	307R4	BE132S4	BX132SB4	—	—	31900	39900	71900	94500	30500	322
3.2	14600	1.0	457	—	309R4	BE132S4	BX132SB4	—	—	—	—	73600	94700	24400	332
3.2	14400	2.0	453	310ML4	—	BE132S4	BX132SB4	—	—	—	—	83100	105300	44000	344
3.2	14500	1.3	454	—	310MR4	BE132S4	BX132SB4	—	—	—	—	83100	105300	44000	346
3.3	14000	2.8	438	—	311MR4	BE132S4	BX132SB4	—	—	—	—	103800	106000	43500	358
3.5	13200	0.9	413	—	307R4	BE132S4	BX132SB4	—	—	31500	39400	70900	93300	29500	322
3.5	13200	1.4	413	—	309R4	BE132S4	BX132SB4	—	—	—	—	72500	93300	23600	332
3.5	13200	3.0	413	—	311MR4	BE132S4	BX132SB4	—	—	—	—	103000	105100	42700	358

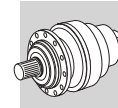

$P_1 = 5.5 \text{ kW}$

n ₂ min ⁻¹	M ₂ Nm	S	i	[Icons]		IE2		IE3		Rn ₂ [N]					[Icon]
				[Icon]	[Icon]	[Icon]	[Icon]	IE2	IE3	MC	MZ	HC/PC	HZ/PZ	FZ	
3.6	12900	0.9	406	307L4	—	BE132S4	BX132SB4	ME4SB4	MX4SB4	31400	39300	70700	93100	29400	320
3.6	12900	1.4	406	309L4	—	BE132S4	BX132SB4	—	—	—	—	72300	93100	23500	334
3.7	12500	1.5	392	310ML4	—	BE132S4	BX132SB4	—	—	—	—	81300	103100	41900	344
3.8	12200	2.0	383	—	310MR4	BE132S4	BX132SB4	—	—	—	—	81100	102800	41600	346
3.9	11900	1.2	374	—	309R4	BE132S4	BX132SB4	—	—	—	—	71500	92000	22900	332
4.0	11600	1.1	363	—	307R4	BE132S4	BX132SB4	—	—	30900	38700	69600	91600	28300	322
4.2	11100	1.3	349	307L4	—	BE132S4	BX132SB4	ME4SB4	MX4SB4	30800	38500	69200	91100	27900	320
4.2	11100	1.9	349	309L4	—	BE132S4	BX132SB4	—	—	—	—	70800	91100	22300	334
4.2	11500	1.6	350	310ML3	—	BE132S4	BX132SB4	—	—	—	—	80100	101500	40400	344
4.2	11000	2.7	347	—	310MR4	BE132S4	BX132SB4	—	—	—	—	79900	101400	40200	346
4.3	11100	1.2	336	309L3	—	BE132S4	BX132SB4	—	—	—	—	70400	90600	22100	334
4.4	10600	1.1	331	—	307R4	BE132S4	BX132SB4	—	—	30500	38200	68700	90400	27400	322
4.4	10600	1.6	331	—	309R4	BE132S4	BX132SB4	—	—	—	—	70300	90400	22000	332
4.8	9720	2.4	305	—	310MR4	BE132S4	BX132SB4	—	—	—	—	78500	99500	38600	346
4.9	9560	1.5	300	—	307R4	BE132S4	BX132SB4	—	—	30100	37600	67800	89100	26600	322
4.9	9700	2.3	295	310ML3	—	BE132S4	BX132SB4	—	—	—	—	78100	99100	38200	344
5.0	9570	2.9	291	311ML3	—	BE132S4	BX132SB4	—	—	—	—	98000	100000	38000	356
5.1	9210	0.9	289	—	306R4	BE132S4	BX132SB4	ME4SB4	MX4SB4	25000	28500	57000	65800	20400	310
5.1	9310	1.2	284	307L3	—	BE132S4	BX132SB4	ME4SB4	MX4SB4	30000	37500	67500	88800	26100	320
5.1	9070	1.2	284	—	307R4	BE132S4	BX132SB4	—	—	30000	37500	67500	88800	26100	322
5.1	9310	1.7	284	309L3	—	BE132S4	BX132SB4	—	—	—	—	69000	88800	20800	334
5.1	9070	1.9	284	—	309R4	BE132S4	BX132SB4	—	—	—	—	69000	88800	20900	332
5.7	8220	1.8	258	—	307R4	BE132S4	BX132SB4	—	—	30000	37500	67500	88800	25300	322
5.7	8220	2.1	258	—	309R4	BE132S4	BX132SB4	—	—	—	—	69000	88800	20200	332
5.7	8230	2.7	258	—	310MR4	BE132S4	BX132SB4	—	—	—	—	78000	98900	36500	346
5.9	7920	1.0	249	—	306R4	BE132S4	BX132SB4	ME4SB4	MX4SB4	25000	28500	57000	65800	19400	310
5.9	8190	2.2	249	310ML3	—	BE132S4	BX132SB4	—	—	—	—	78000	98900	36100	344
6.1	7820	1.0	238	306L3	—	BE132S4	BX132SB4	ME4SB4	MX4SB4	25000	28500	57000	65800	19100	308
6.1	7860	1.1	239	307L3	—	BE132S4	BX132SB4	ME4SB4	MX4SB4	30000	37500	67500	88800	24600	320
6.1	7860	1.7	239	309L3	—	BE132S4	BX132SB4	—	—	—	—	69000	88800	19700	334
6.3	7340	1.0	230	—	306R4	BE132S4	BX132SB4	ME4SB4	MX4SB4	25000	28500	57000	65800	18900	310
6.3	7400	1.5	232	—	307R4	BE132S4	BX132SB4	—	—	30000	37500	67500	88800	24400	322
6.3	7400	2.3	232	—	309R4	BE132S4	BX132SB4	—	—	—	—	69000	88800	19500	332
6.3	7560	2.6	230	310ML3	—	BE132S4	BX132SB4	—	—	—	—	78000	98900	35100	344
6.6	7260	1.8	221	307L3	—	BE132S4	BX132SB4	ME4SB4	MX4SB4	30000	37500	67500	88800	24000	320
6.6	7320	1.8	223	309L3	—	BE132S4	BX132SB4	—	—	—	—	69000	88800	19200	334
6.8	6810	1.4	214	—	306R4	BE132S4	BX132SB4	ME4SB4	MX4SB4	25000	28500	57000	65800	18400	310
7.1	6730	1.2	205	306L3	—	BE132S4	BX132SB4	ME4SB4	MX4SB4	25000	28500	57000	65800	18200	308
7.1	6550	2.2	206	—	307R4	BE132S4	BX132SB4	—	—	30000	37500	67500	88800	23400	322
7.2	6620	1.7	202	307L3	—	BE132S4	BX132SB4	ME4SB4	MX4SB4	30000	37500	67500	88800	23300	320
7.2	6620	2.5	202	309L3	—	BE132S4	BX132SB4	—	—	—	—	69000	88800	18600	334
7.7	6230	1.0	190	306L3	—	BE132S4	BX132SB4	ME4SB4	MX4SB4	25000	28500	57000	65800	17700	308
7.7	6080	2.3	191	—	307R4	BE132S4	BX132SB4	—	—	30000	37500	67500	88800	22800	322
7.7	6080	2.8	191	—	309R4	BE132S4	BX132SB4	—	—	—	—	69000	88800	18300	332
8.0	6000	2.4	183	309L3	—	BE132S4	BX132SB4	—	—	—	—	69000	88800	18000	334
8.1	5770	1.6	181	—	306R4	BE132S4	BX132SB4	ME4SB4	MX4SB4	25000	28500	57000	65800	17500	310
8.2	5820	2.1	177	307L3	—	BE132S4	BX132SB4	ME4SB4	MX4SB4	30000	37500	67500	88800	22300	320
8.7	5350	1.4	168	—	306R4	BE132S4	BX132SB4	ME4SB4	MX4SB4	25000	28500	57000	65800	17000	310
8.8	5260	2.1	165	—	307R4	BE132S4	BX132SB4	—	—	30000	37500	67500	88800	21800	322
9.0	5310	2.0	162	307L3	—	BE132S4	BX132SB4	ME4SB4	MX4SB4	30000	37500	67500	88800	21600	320
9.2	5050	1.1	158	—	305R4	BE132S4	BX132SB4	ME4SB4	MX4SB4	21000	24000	40500	48000	11400	298
9.2	5030	1.9	158	—	306R4	BE132S4	BX132SB4	ME4SB4	MX4SB4	25000	28500	57000	65800	16700	310
9.6	4990	1.5	152	306L3	—	BE132S4	BX132SB4	ME4SB4	MX4SB4	25000	28500	57000	65800	16500	308
9.6	4840	2.8	152	—	307R4	BE132S4	BX132SB4	—	—	30000	37500	67500	88800	21200	322
9.9	4720	1.0	148	—	305R4	BE132S4	BX132SB4	ME4SB4	MX4SB4	21000	24000	40500	48000	11200	298
10.0	4810	2.8	146	307L3	—	BE132S4	BX132SB4	ME4SB4	MX4SB4	30000	37500	67500	88800	20900	320
10.1	4740	1.2	144	—	306R3	BE132S4	BX132SB4	ME4SB4	MX4SB4	24900	28400	56800	65500	16200	310
10.3	4650	1.1	141	305L3	—	BE132S4	BX132SB4	ME4SB4	MX4SB4	20800	23700	40100	47500	11000	296
10.4	4630	1.7	141	306L3	—	BE132S4	BX132SB4	ME4SB4	MX4SB4	24700	28200	56400	65100	16100	308
10.5	4560	2.4	139	307L3	—	BE132S4	BX132SB4	ME4SB4	MX4SB4	29500	36900	66500	87500	20500	320
11.3	4120	1.3	129	—	305R4	BE132S4	BX132SB4	ME4SB4	MX4SB4	20200	23000	39000	46300	10700	298
12.0	3980	2.0	121	306L3	—	BE132S4	BX132SB4	ME4SB4	MX4SB4	23500	26800	53900	62200	15300	308
12.2	3930	2.2	120	—	307R3	BE132S4	BX132SB4	ME4SB4	MX4SB4	28100	35100	63600	83700	19600	322
12.3	3920	1.7	119	—	306R3	BE132S4	BX132SB4	ME4SB4	MX4SB4	23400	26600	53600	61900	15200	310
12.8	3760	1.0	114	—	305R3	BE132S4	BX132SB4	ME4SB4	MX4SB4	19400	22100	37600	44600	10300	298

A

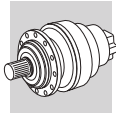

$P_1 = 5.5 \text{ kW}$

n ₂ min ⁻¹	M ₂ Nm	S	i	[Icons]		IE2		IE3		Rn ₂ [N]					[Icon]
				[Icon]	[Icon]	[Icon]	[Icon]	IE2	IE3	MC	MZ	HC/PC	HZ/PZ	FZ	
12.9	3720	2.8	113	307L3	—	BE132S4	BX132SB4	ME4SB4	MX4SB4	27600	34500	62600	82300	19200	320
13.0	3700	1.0	113	305L3	—	BE132S4	BX132SB4	ME4SB4	MX4SB4	19300	22000	37500	44400	10200	296
13.0	3690	2.0	112	306L3	—	BE132S4	BX132SB4	ME4SB4	MX4SB4	22900	26100	52700	60800	14900	308
13.2	3630	0.9	111	304L3	—	BE132S4	BX132SB4	ME4SB4	MX4SB4	19100	21900	37300	44200	10200	284
13.3	3490	1.0	109	—	304R4	BE132S4	BX132SB4	—	—	19100	21800	37200	44000	10100	286
14.0	3430	1.0	105	304L3	—	BE132S4	BX132SB4	ME4SB4	MX4SB4	18800	21500	36600	43400	9970	284
14.0	3430	1.5	105	305L3	—	BE132S4	BX132SB4	ME4SB4	MX4SB4	18800	21500	36600	43400	9970	296
14.0	3420	2.6	104	306L3	—	BE132S4	BX132SB4	ME4SB4	MX4SB4	22300	25500	51500	59500	14500	308
14.7	3250	2.6	99.0	—	307R3	BE132S4	BX132SB4	ME4SB4	MX4SB4	26400	32900	60100	79000	18300	322
14.8	3240	2.0	98.5	—	306R3	BE132S4	BX132SB4	ME4SB4	MX4SB4	21900	25000	50700	58500	14200	310
16.0	3010	1.2	91.5	—	305R3	BE132S4	BX132SB4	ME4SB4	MX4SB4	18000	20500	35200	41700	9530	298
16.2	2960	1.1	90.2	304L3	—	BE132S4	BX132SB4	ME4SB4	MX4SB4	17900	20400	35100	41500	9490	284
16.2	2960	1.4	90.2	305L3	—	BE132S4	BX132SB4	ME4SB4	MX4SB4	17900	20400	35100	41500	9490	296
16.3	2850	1.2	89.4	—	304R4	BE132S4	BX132SB4	—	—	17800	20400	35000	41400	9460	286
16.5	2900	3.0	88.3	306L3	—	BE132S4	BX132SB4	ME4SB4	MX4SB4	21100	24100	49000	56600	13700	308
17.2	2780	2.7	84.7	—	306R3	BE132S4	BX132SB4	ME4SB4	MX4SB4	20900	23800	48400	55900	13600	310
17.8	2690	2.6	81.9	306L3	—	BE132S4	BX132SB4	ME4SB4	MX4SB4	20600	23500	47900	55300	13400	308
18.5	2590	1.1	78.7	—	304R3	BE132S4	BX132SB4	—	—	17100	19500	33600	39900	9070	286
18.5	2590	1.7	78.7	—	305R3	BE132S4	BX132SB4	ME4SB4	MX4SB4	17100	19500	33600	39900	9070	298
18.9	2540	1.0	77.2	303L3	—	BE132S4	BX132SB4	ME4SB4	MX4SB4	17000	19400	33500	39700	9010	272
18.9	2540	1.4	77.2	304L3	—	BE132S4	BX132SB4	ME4SB4	MX4SB4	17000	19400	33500	39700	9010	284
18.9	2540	1.9	77.2	305L3	—	BE132S4	BX132SB4	ME4SB4	MX4SB4	17000	19400	33500	39700	9010	296
19.9	2410	1.5	73.3	—	305R3	BE132S4	BX132SB4	ME4SB4	MX4SB4	16700	19100	32900	39000	8850	298
20.1	2460	2.2	72.5	306L2	—	BE132S4	BX132SB4	ME4SB4	MX4SB4	19800	22600	46200	53300	12900	308
20.2	2370	0.9	72.3	303L3	—	BE132S4	BX132SB4	ME4SB4	MX4SB4	16600	19000	32800	38900	8810	272
20.2	2370	1.4	72.3	304L3	—	BE132S4	BX132SB4	ME4SB4	MX4SB4	16600	19000	32800	38900	8810	284
20.2	2370	1.8	72.3	305L3	—	BE132S4	BX132SB4	ME4SB4	MX4SB4	16600	19000	32800	38900	8810	296
23.1	2070	1.0	63.1	—	303R3	BE132S4	BX132SB4	—	—	15900	18100	31500	37300	8420	274
23.1	2070	1.4	63.1	—	304R3	BE132S4	BX132SB4	—	—	15900	18100	31500	37300	8420	286
23.1	2070	2.1	63.1	—	305R3	BE132S4	BX132SB4	ME4SB4	MX4SB4	15900	18100	31500	37300	8420	298
23.2	2070	1.2	63.1	303L3	—	BE132S4	BX132SB4	ME4SB4	MX4SB4	15900	18100	31500	37300	8420	272
23.2	2070	1.7	63.1	304L3	—	BE132S4	BX132SB4	ME4SB4	MX4SB4	15900	18100	31500	37300	8420	284
23.2	2070	2.3	63.1	305L3	—	BE132S4	BX132SB4	ME4SB4	MX4SB4	15900	18100	31500	37300	8420	296
24.7	2000	1.2	59.1	304L2	—	BE132S4	BX132SB4	ME4SB4	MX4SB4	15500	17800	30900	36600	8240	284
26.0	1910	2.7	56.3	306L2	—	BE132S4	BX132SB4	ME4SB4	MX4SB4	18200	20700	42800	49400	11800	308
26.2	1890	1.0	55.8	303L2	—	BE132S4	BX132SB4	ME4SB4	MX4SB4	15200	17400	30300	36000	8080	272
26.2	1890	1.9	55.8	305L2	—	BE132S4	BX132SB4	ME4SB4	MX4SB4	15200	17400	30300	36000	8080	296
26.9	1780	1.0	54.2	—	303R3	BE132S4	BX132SB4	—	—	15100	17200	30100	35700	8010	274
26.9	1780	2.0	54.2	—	305R3	BE132S4	BX132SB4	ME4SB4	MX4SB4	15100	17200	30100	35700	8010	298
27.3	1750	1.2	53.4	303L3	—	BE132S4	BX132SB4	ME4SB4	MX4SB4	15000	17200	30000	35500	7970	272
27.3	1750	1.8	53.4	304L3	—	BE132S4	BX132SB4	ME4SB4	MX4SB4	15000	17200	30000	35500	7970	284
27.3	1750	2.3	53.4	305L3	—	BE132S4	BX132SB4	ME4SB4	MX4SB4	15000	17200	30000	35500	7970	296
28.3	1700	1.0	51.6	301L3	—	BE132S4	BX132SB4	ME4SB4	MX4SB4	4600	4600	15700	17200	2630	262
29.0	1660	1.0	50.4	—	301R3	BE132S4	BX132SB4	—	—	4560	4560	15600	17100	2610	264
29.0	1650	1.4	50.3	—	303R3	BE132S4	BX132SB4	—	—	14700	16800	29400	34900	7810	274
29.0	1650	2.1	50.3	—	304R3	BE132S4	BX132SB4	—	—	14700	16800	29400	34900	7810	286
29.0	1650	2.7	50.3	—	305R3	BE132S4	BX132SB4	ME4SB4	MX4SB4	14700	16800	29400	34900	7810	298
31	1530	1.4	46.6	—	303R3	BE132S4	BX132SB4	—	—	14400	16400	28800	34100	7610	274
31	1600	1.5	47.3	304L2	—	BE132S4	BX132SB4	ME4SB4	MX4SB4	14400	16500	28900	34200	7650	284
31	1530	1.9	46.6	—	304R3	BE132S4	BX132SB4	—	—	14400	16400	28800	34100	7610	286
31	1530	2.8	46.6	—	305R3	BE132S4	BX132SB4	ME4SB4	MX4SB4	14400	16400	28800	34100	7610	298
33	1510	1.2	44.6	303L2	—	BE132S4	BX132SB4	ME4SB4	MX4SB4	14100	16200	28400	33600	7500	272
33	1430	2.2	43.6	304L3	—	BE132S4	BX132SB4	ME4SB4	MX4SB4	14000	16000	28200	33400	7450	284
33	1510	2.4	44.6	305L2	—	BE132S4	BX132SB4	ME4SB4	MX4SB4	14100	16200	28400	33600	7500	296
34	1400	1.5	42.6	—	303R3	BE132S4	BX132SB4	—	—	13900	15900	28000	33200	7390	274
34	1400	2.3	42.6	—	304R3	BE132S4	BX132SB4	—	—	13900	15900	28000	33200	7390	286
34	1400	2.7	42.6	—	305R3	BE132S4	BX132SB4	ME4SB4	MX4SB4	13900	15900	28000	33200	7390	298
35	1410	0.9	41.5	301L2	—	BE132S4	BX132SB4	ME4SB4	MX4SB4	4280	4280	14700	16100	2440	262
35	1350	1.0	41.2	—	301R3	BE132S4	BX132SB4	—	—	4260	4260	14700	16100	2430	264
38	1300	1.2	38.4	301L2	—	BE132S4	BX132SB4	ME4SB4	MX4SB4	4160	4160	14400	15700	2380	262
38	1300	1.7	38.4	303L2	—	BE132S4	BX132SB4	ME4SB4	MX4SB4	13500	15400	27100	32200	7140	272
38	1300	2.2	38.4	304L2	—	BE132S4	BX132SB4	ME4SB4	MX4SB4	13500	15400	27100	32200	7140	284
39	1220	1.3	37.3	—	301R3	BE132S4	BX132SB4	—	—	4120	4120	14300	15600	2360	264
39	1220	2.0	37.1	—	303R3	BE132S4	BX132SB4	—	—	13300	15200	26900	31800	7060	274
39	1220	2.8	37.1	—	304R3	BE132S4	BX132SB4	—	—	13300	15200	26900	31800	7060	286

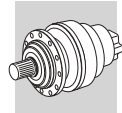

$P_1 = 5.5 \text{ kW}$

n ₂ min ⁻¹	M ₂ Nm	S	i	[Icons]		IE2		IE3		Rn ₂ [N]					[Icon]
				[Icon]	[Icon]	[Icon]	[Icon]	IE2	IE3	MC	MZ	HC/PC	HZ/PZ	FZ	
41	1210	1.5	35.8	303L2	—	BE132S4	BX132SB4	ME4SB4	MX4SB4	13100	15000	26600	31500	6970	272
41	1210	2.9	35.8	305L2	—	BE132S4	BX132SB4	ME4SB4	MX4SB4	13100	15000	26600	31500	6970	296
44	1130	1.2	33.3	301L2	—	BE132S4	BX132SB4	ME4SB4	MX4SB4	3970	3970	13800	15100	2270	262
46	1030	2.0	31.5	—	303R3	BE132S4	BX132SB4	—	—	12600	14400	25600	30300	6680	274
46	1030	3.0	31.5	—	304R3	BE132S4	BX132SB4	—	—	12600	14400	25600	30300	6680	286
47	1040	2.1	30.8	303L2	—	BE132S4	BX132SB4	ME4SB4	MX4SB4	12500	14300	25400	30100	6630	272
47	1040	2.7	30.8	304L2	—	BE132S4	BX132SB4	ME4SB4	MX4SB4	12500	14300	25400	30100	6630	284
48	1040	1.5	30.7	301L2	—	BE132S4	BX132SB4	ME4SB4	MX4SB4	3870	3870	13500	14700	2210	262
48	1000	1.6	30.4	—	301R3	BE132S4	BX132SB4	—	—	3850	3850	13400	14700	2200	264
55	900	2.0	26.4	303L2	—	BE132S4	BX132SB4	ME4SB4	MX4SB4	11900	13600	24300	28700	6300	272
57	840	2.4	25.7	—	303R3	BE132S4	BX132SB4	—	—	11800	13400	24000	28500	6240	274
59	830	1.0	24.6	300L2	—	BE132S4	BX132SB4	ME4SB4	MX4SB4	3590	3590	12600	14700	2050	252
59	830	1.8	24.6	301L2	—	BE132S4	BX132SB4	ME4SB4	MX4SB4	3590	3590	12600	13800	2050	262
59	820	1.7	24.8	—	301R3	BE132S4	BX132SB4	—	—	3600	3600	12600	13800	2060	264
59	840	1.0	24.8	—	303R2	BE132S4	BX132SB4	ME4SB4	MX4SB4	11600	13300	23800	28200	6170	274
60	830	2.6	24.5	303L2	—	BE132S4	BX132SB4	ME4SB4	MX4SB4	11600	13200	23700	28100	6150	272
64	770	2.7	22.7	303L2	—	BE132S4	BX132SB4	ME4SB4	MX4SB4	11300	12900	23200	27500	5990	272
70	700	2.6	20.8	303L2	—	BE132S4	BX132SB4	ME4SB4	MX4SB4	11000	12500	22600	26700	5820	272
73	680	0.9	20.1	300L2	—	BE132S4	BX132SB4	ME4SB4	MX4SB4	3360	3360	11900	13800	1920	252
73	680	1.9	20.1	301L2	—	BE132S4	BX132SB4	ME4SB4	MX4SB4	3360	3360	11900	13000	1920	262
76	650	2.4	19.2	—	303R2	BE132S4	BX132SB4	ME4SB4	MX4SB4	10700	12200	22000	26100	5670	274
79	620	1.2	18.5	—	301R2	BE132S4	BX132SB4	ME4SB4	MX4SB4	3260	3260	11600	12600	1860	264
80	620	1.2	18.2	300L2	—	BE132S4	BX132SB4	ME4SB4	MX4SB4	3250	3250	11500	13400	1850	252
80	620	2.2	18.2	301L2	—	BE132S4	BX132SB4	ME4SB4	MX4SB4	3250	3250	11500	12600	1850	262
98	500	1.4	14.8	300L2	—	BE132S4	BX132SB4	ME4SB4	MX4SB4	3030	3030	10800	12600	1730	252
98	500	2.6	14.8	301L2	—	BE132S4	BX132SB4	ME4SB4	MX4SB4	3030	3030	10800	11800	1730	262
99	500	1.0	14.8	—	300R2	BE132S4	BX132SB4	ME4SB4	MX4SB4	3030	3030	10800	12600	1730	254
99	500	1.9	14.8	—	301R2	BE132S4	BX132SB4	ME4SB4	MX4SB4	3030	3030	10800	11800	1730	264
121	410	1.7	12.1	300L2	—	BE132S4	BX132SB4	ME4SB4	MX4SB4	2830	2830	10200	11800	1620	252
121	410	3.0	12.1	301L2	—	BE132S4	BX132SB4	ME4SB4	MX4SB4	2830	2830	10200	11100	1620	262
123	400	1.5	11.8	—	300R2	BE132S4	BX132SB4	ME4SB4	MX4SB4	2810	2810	10100	11800	1610	254
123	400	2.9	11.8	—	301R2	BE132S4	BX132SB4	ME4SB4	MX4SB4	2810	2810	10100	11100	1610	264
151	340	2.3	9.67	303L1	—	BE132S4	BX132SB4	ME4SB4	MX4SB4	8500	9710	17900	21300	4510	272
162	310	1.0	9.00	300L1	—	BE132S4	BX132SB4	ME4SB4	MX4SB4	2570	2570	9320	10800	1470	252
162	310	2.0	9.00	301L1	—	BE132S4	BX132SB4	ME4SB4	MX4SB4	2570	2570	9320	10200	1470	262
167	300	2.1	8.74	—	300R2	BE132S4	BX132SB4	ME4SB4	MX4SB4	2540	2540	9240	10700	1450	254
203	250	1.6	7.20	300L1	—	BE132S4	BX132SB4	ME4SB4	MX4SB4	2380	2380	8720	10100	1360	252
205	240	2.4	7.13	—	300R2	BE132S4	BX132SB4	ME4SB4	MX4SB4	2380	2380	8690	10100	1360	254
253	200	2.4	5.77	300L1	—	BE132S4	BX132SB4	ME4SB4	MX4SB4	2210	2210	8160	9480	1260	252

$P_1 = 7.5 \text{ kW}$

n ₂ min ⁻¹	M ₂ Nm	S	i	[Icons]		IE2		IE3		Rn ₂ [N]					[Icon]
				[Icon]	[Icon]	[Icon]	[Icon]	IE2	IE3	MC	MZ	HC/PC	HZ/PZ	FZ	
0.77	82100	1.8	1893	317ML4	—	BE132MA4	BX132MA4	—	—	—	—	410500	436100	150000	414
0.81	78300	1.0	1805	315ML4	—	BE132MA4	BX132MA4	—	—	—	—	171200	205400	90000	392
0.92	69200	2.3	1595	317ML4	—	BE132MA4	BX132MA4	—	—	—	—	400600	425500	150000	414
0.94	67400	1.8	1553	316ML4	—	BE132MA4	BX132MA4	—	—	—	—	256500	287700	150000	404
0.98	64400	1.0	1485	314ML4	—	BE132MA4	BX132MA4	—	—	—	—	166500	199700	90000	380
0.98	64700	1.2	1492	315ML4	—	BE132MA4	BX132MA4	—	—	—	—	166600	199800	90000	392
1.1	55400	1.3	1277	314ML4	—	BE132MA4	BX132MA4	—	—	—	—	163000	195500	86100	380
1.1	55700	1.6	1284	315ML4	—	BE132MA4	BX132MA4	—	—	—	—	163100	195600	86200	392
1.1	56800	2.1	1308	316ML4	—	BE132MA4	BX132MA4	—	—	—	—	250300	280700	144600	404
1.1	57200	2.7	1318	317ML4	—	BE132MA4	BX132MA4	—	—	—	—	389800	414100	145000	414
1.2	54900	1.0	1266	313ML4	—	BE132MA4	BX132MA4	—	—	—	—	175100	205200	76300	368
1.2	53700	2.2	1237	316ML4	—	BE132MA4	BX132MA4	—	—	—	—	248300	278500	142000	404
1.3	48500	1.0	1117	313ML4	—	BE132MA4	BX132MA4	—	—	—	—	172000	201600	73200	368
1.3	47700	1.5	1099	314ML4	—	BE132MA4	BX132MA4	—	—	—	—	159500	191300	81900	380
1.3	47900	1.9	1104	315ML4	—	BE132MA4	BX132MA4	—	—	—	—	159600	191400	82000	392
1.3	47900	2.5	1104	316ML4	—	BE132MA4	BX132MA4	—	—	—	—	244300	274000	136700	404
1.4	45900	1.0	1058	311ML4	—	BE132MA4	BX132MA4	—	—	—	—	117800	120200	58400	356
1.4	44000	1.2	1014	313ML4	—	BE132MA4	BX132MA4	—	—	—	—	169600	198800	70800	368



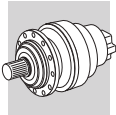

$P_1 = 7.5 \text{ kW}$

n_2 min ⁻¹	M_2 Nm	S	i	IE2		IE3		IE2		IE3		R _{n2} [N]					
				MC	MZ	HC/PC	HZ/PZ	FZ									
1.4	45000	1.7	1038	314ML4	—	BE132MA4	BX132MA4	—	—	—	—	158200	189700	80300	380		
1.4	45200	2.2	1043	315ML4	—	BE132MA4	BX132MA4	—	—	—	—	158300	189900	80400	392		
1.4	44200	2.7	1020	316ML4	—	BE132MA4	BX132MA4	—	—	—	—	241500	270900	133100	404		
1.5	42800	1.1	986	311ML4	—	BE132MA4	BX132MA4	—	—	—	—	116600	119000	57000	356		
1.6	38600	1.4	889	313ML4	—	BE132MA4	BX132MA4	—	—	—	—	166500	195100	67800	368		
1.6	40200	1.8	926	314ML4	—	BE132MA4	BX132MA4	—	—	—	—	155700	186700	77300	380		
1.6	40400	2.2	930	315ML4	—	BE132MA4	BX132MA4	—	—	—	—	155800	186800	77500	392		
1.6	39400	1.8	909	—	315MR4	BE132MA4	BX132MA4	—	—	—	—	155300	186200	76900	394		
1.7	37200	2.0	858	314ML4	—	BE132MA4	BX132MA4	—	—	—	—	154000	184600	75400	380		
1.7	37400	2.6	862	315ML4	—	BE132MA4	BX132MA4	—	—	—	—	154100	184800	75500	392		
1.8	35800	1.2	825	311ML4	—	BE132MA4	BX132MA4	—	—	—	—	113700	116000	53700	356		
1.8	34300	1.4	790	313ML4	—	BE132MA4	BX132MA4	—	—	—	—	163700	191800	65200	368		
1.9	33800	1.1	778	—	313MR4	BE132MA4	BX132MA4	—	—	—	—	163300	191400	64900	370		
1.9	33900	2.6	782	—	315MR4	BE132MA4	BX132MA4	—	—	—	—	152000	182200	73100	394		
2.0	32400	1.0	746	—	311MR4	BE132MA4	BX132MA4	—	—	—	—	112100	114300	52000	358		
2.0	32000	2.3	738	314ML4	—	BE132MA4	BX132MA4	—	—	—	—	150700	180700	71700	380		
2.0	32200	3.0	741	315ML4	—	BE132MA4	BX132MA4	—	—	—	—	150800	180800	71800	392		
2.1	30200	1.7	695	313ML4	—	BE132MA4	BX132MA4	—	—	—	—	160700	188300	62500	368		
2.2	29000	2.6	668	314ML4	—	BE132MA4	BX132MA4	—	—	—	—	148600	178200	69400	380		
2.2	28600	3.0	659	—	315MR4	BE132MA4	BX132MA4	—	—	—	—	148300	177800	69000	394		
2.3	27600	0.9	637	310ML4	—	BE132MA4	BX132MA4	—	—	—	—	87200	110500	49300	344		
2.3	27200	1.5	627	311ML4	—	BE132MA4	BX132MA4	—	—	—	—	109300	111500	49000	356		
2.3	27300	1.5	629	—	311MR4	BE132MA4	BX132MA4	—	—	—	—	109300	111600	49100	358		
2.3	27500	1.8	633	313ML4	—	BE132MA4	BX132MA4	—	—	—	—	158600	185800	60500	368		
2.3	28100	1.8	647	—	313MR4	BE132MA4	BX132MA4	—	—	—	—	159100	186400	61000	370		
2.4	26600	2.0	614	—	314MR4	BE132MA4	BX132MA4	—	—	—	—	146800	176000	67400	382		
2.5	25600	1.0	590	310ML4	—	BE132MA4	BX132MA4	—	—	—	—	86200	109300	48000	344		
2.5	24900	2.7	575	314ML4	—	BE132MA4	BX132MA4	—	—	—	—	145400	174400	66000	380		
2.5	25500	2.8	588	314ML4	—	BE132MA4	BX132MA4	—	—	—	—	145900	174900	66500	380		
2.6	24600	1.7	568	311ML4	—	BE132MA4	BX132MA4	—	—	—	—	107800	110000	47400	356		
2.6	24500	2.2	564	313ML4	—	BE132MA4	BX132MA4	—	—	—	—	156000	182800	58300	368		
2.7	23200	2.1	535	—	313MR4	BE132MA4	BX132MA4	—	—	—	—	154800	181400	57200	370		
2.8	22400	1.1	517	—	310MR4	BE132MA4	BX132MA4	—	—	—	—	84600	107300	46000	346		
2.8	22500	1.8	520	—	311MR4	BE132MA4	BX132MA4	—	—	—	—	106400	108600	46100	358		
2.8	22300	2.1	514	313ML4	—	BE132MA4	BX132MA4	—	—	—	—	153900	180400	56500	368		
2.8	22900	2.9	528	—	314MR4	BE132MA4	BX132MA4	—	—	—	—	143700	172300	64100	382		
2.9	22000	1.1	507	310ML4	—	BE132MA4	BX132MA4	—	—	—	—	84400	107000	45700	344		
2.9	22200	2.1	512	311ML4	—	BE132MA4	BX132MA4	—	—	—	—	106200	108400	45800	356		
2.9	21500	2.3	496	—	313MR4	BE132MA4	BX132MA4	—	—	—	—	153200	179500	55800	370		
3.0	21300	1.5	490	—	311MR4	BE132MA4	BX132MA4	—	—	—	—	105500	107700	45200	358		
3.1	20200	0.9	465	309L4	—	BE132MA4	BX132MA4	—	—	—	—	73700	94900	24600	334		
3.2	19700	1.5	453	310ML4	—	BE132MA4	BX132MA4	—	—	—	—	83100	105300	44000	344		
3.2	19700	1.0	454	—	310MR4	BE132MA4	BX132MA4	—	—	—	—	83100	105300	44000	346		
3.2	19600	2.9	452	313ML4	—	BE132MA4	BX132MA4	—	—	—	—	151100	177100	54100	368		
3.2	19500	2.4	450	—	313MR4	BE132MA4	BX132MA4	—	—	—	—	151100	177000	54100	370		
3.3	19000	2.1	438	—	311MR4	BE132MA4	BX132MA4	—	—	—	—	103800	106000	43500	358		
3.5	17900	1.0	413	—	309R4	BE132MA4	BX132MA4	—	—	—	—	72500	93300	23600	332		
3.5	17900	2.2	413	—	311MR4	BE132MA4	BX132MA4	—	—	—	—	103000	105100	42700	358		
3.6	17600	1.0	406	309L4	—	BE132MA4	BX132MA4	—	—	—	—	72300	93100	23500	334		
3.6	17800	2.6	410	311ML4	—	BE132MA4	BX132MA4	—	—	—	—	102900	105000	42600	356		
3.7	17000	1.1	392	310ML4	—	BE132MA4	BX132MA4	—	—	—	—	81300	103100	41900	344		
3.8	16600	1.4	383	—	310MR4	BE132MA4	BX132MA4	—	—	—	—	81100	102800	41600	346		
3.8	16800	2.7	387	—	313MR4	BE132MA4	BX132MA4	—	—	—	—	147900	173300	51400	370		
4.2	15100	1.0	349	307L4	—	BE132MA4	BX132MA4	ME4LA4	MX4LA4	30800	38500	69200	91100	27900	320		
4.2	15100	1.4	349	309L4	—	BE132MA4	BX132MA4	—	—	—	—	70800	91100	22300	334		
4.2	15700	1.2	350	310ML3	—	BE132MA4	BX132MA4	—	—	—	—	80100	101500	40400	344		
4.2	15000	2.0	347	—	310MR4	BE132MA4	BX132MA4	—	—	—	—	79900	101400	40200	346		
4.3	14800	2.5	341	—	311MR4	BE132MA4	BX132MA4	—	—	—	—	100200	102300	40000	358		
4.4	14400	1.2	331	—	309R4	BE132MA4	BX132MA4	—	—	—	—	70300	90400	22000	332		
4.8	13200	1.7	305	—	310MR4	BE132MA4	BX132MA4	—	—	—	—	78500	99500	38600	346		
4.8	13600	2.2	304	313ML3	—	BE132MA4	BX132MA4	—	—	—	—	142800	167300	47400	368		
4.9	13000	1.1	300	—	307R4	BE132MA4	BX132MA4	—	—	30100	37600	67800	89100	26600	322		
4.9	13200	1.7	295	310ML3	—	BE132MA4	BX132MA4	—	—	—	—	78100	99100	38200	344		
5.0	13000	2.1	291	311ML3	—	BE132MA4	BX132MA4	—	—	—	—	98000	100000	38000	356		
5.0	12700	2.9	294	—	311MR4	BE132MA4	BX132MA4	—	—	—	—	98100	100100	38100	358		

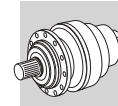

$P_1 = 7.5 \text{ kW}$

n ₂ min ⁻¹	M ₂ Nm	S	i	IE2		IE3		IE2		IE3		Rn ₂ [N]					Icon
				MC	MZ	HC/PC	HZ/PZ	FZ									
5.1	12300	0.9	284	—	307R4	BE132MA4	BX132MA4	—	—	30000	37500	67500	88800	26100	322		
5.1	12700	1.2	284	309L3	—	BE132MA4	BX132MA4	—	—	—	—	69000	88800	20800	334		
5.1	12300	1.4	284	—	309R4	BE132MA4	BX132MA4	—	—	—	—	69000	88800	20900	332		
5.3	12000	2.3	276	—	310MR4	BE132MA4	BX132MA4	—	—	—	—	78000	98900	37300	346		
5.7	11200	1.3	258	—	307R4	BE132MA4	BX132MA4	—	—	30000	37500	67500	88800	25300	322		
5.7	11200	1.6	258	—	309R4	BE132MA4	BX132MA4	—	—	—	—	69000	88800	20200	332		
5.7	11200	2.0	258	—	310MR4	BE132MA4	BX132MA4	—	—	—	—	78000	98900	36500	346		
5.9	11100	1.6	249	310ML3	—	BE132MA4	BX132MA4	—	—	—	—	78000	98900	36100	344		
6.1	10700	1.2	239	309L3	—	BE132MA4	BX132MA4	—	—	—	—	69000	88800	19700	334		
6.1	10300	2.8	238	—	310MR4	BE132MA4	BX132MA4	—	—	—	—	78000	98900	35500	346		
6.3	10100	1.1	232	—	307R4	BE132MA4	BX132MA4	—	—	30000	37500	67500	88800	24400	322		
6.3	10100	1.7	232	—	309R4	BE132MA4	BX132MA4	—	—	—	—	69000	88800	19500	332		
6.3	10300	1.9	230	310ML3	—	BE132MA4	BX132MA4	—	—	—	—	78000	98900	35100	344		
6.6	9880	1.3	221	307L3	—	BE132MA4	BX132MA4	ME4LA4	MX4LA4	30000	37500	67500	88800	24000	320		
6.6	9970	1.3	223	309L3	—	BE132MA4	BX132MA4	—	—	—	—	69000	88800	19200	334		
6.8	9270	1.1	214	—	306R4	BE132MA4	BX132MA4	ME4LA4	MX4LA4	25000	28500	57000	65800	18400	310		
7.1	8920	1.6	206	—	307R4	BE132MA4	BX132MA4	—	—	30000	37500	67500	88800	23400	322		
7.1	8920	2.2	206	—	309R4	BE132MA4	BX132MA4	—	—	—	—	69000	88800	18700	332		
7.1	8930	2.5	206	—	310MR4	BE132MA4	BX132MA4	—	—	—	—	78000	98900	33800	346		
7.2	9020	1.2	202	307L3	—	BE132MA4	BX132MA4	ME4LA4	MX4LA4	30000	37500	67500	88800	23300	320		
7.2	9020	1.8	202	309L3	—	BE132MA4	BX132MA4	—	—	—	—	69000	88800	18600	334		
7.2	9030	2.5	202	310ML3	—	BE132MA4	BX132MA4	—	—	—	—	78000	98900	33600	344		
7.7	8270	1.7	191	—	307R4	BE132MA4	BX132MA4	—	—	30000	37500	67500	88800	22800	322		
7.7	8270	2.1	191	—	309R4	BE132MA4	BX132MA4	—	—	—	—	69000	88800	18300	332		
8.0	8170	1.8	183	309L3	—	BE132MA4	BX132MA4	—	—	—	—	69000	88800	18000	334		
8.1	7850	1.2	181	—	306R4	BE132MA4	BX132MA4	ME4LA4	MX4LA4	25000	28500	57000	65800	17500	310		
8.2	7920	1.6	177	307L3	—	BE132MA4	BX132MA4	ME4LA4	MX4LA4	30000	37500	67500	88800	22300	320		
8.2	7930	2.3	177	310ML3	—	BE132MA4	BX132MA4	—	—	—	—	78000	98900	32200	344		
8.7	7280	1.0	168	—	306R4	BE132MA4	BX132MA4	ME4LA4	MX4LA4	25000	28500	57000	65800	17000	310		
8.8	7170	1.5	165	—	307R4	BE132MA4	BX132MA4	—	—	30000	37500	67500	88800	21800	322		
8.8	7170	2.3	165	—	309R4	BE132MA4	BX132MA4	—	—	—	—	69000	88800	17400	332		
9.0	7220	1.5	162	307L3	—	BE132MA4	BX132MA4	ME4LA4	MX4LA4	30000	37500	67500	88800	21600	320		
9.0	7220	2.3	162	309L3	—	BE132MA4	BX132MA4	—	—	—	—	69000	88800	17300	334		
9.2	6850	1.4	158	—	306R4	BE132MA4	BX132MA4	ME4LA4	MX4LA4	25000	28500	57000	65800	16700	310		
9.6	6800	1.1	152	306L3	—	BE132MA4	BX132MA4	ME4LA4	MX4LA4	25000	28500	57000	65800	16500	308		
9.6	6590	2.1	152	—	307R4	BE132MA4	BX132MA4	—	—	30000	37500	67500	88800	21200	322		
9.6	6590	2.8	152	—	309R4	BE132MA4	BX132MA4	—	—	—	—	69000	88800	16900	332		
10.0	6540	2.1	146	307L3	—	BE132MA4	BX132MA4	ME4LA4	MX4LA4	30000	37500	67500	88800	20900	320		
10.4	6300	1.3	141	306L3	—	BE132MA4	BX132MA4	ME4LA4	MX4LA4	24700	28200	56400	65100	16100	308		
10.5	6210	1.7	139	307L3	—	BE132MA4	BX132MA4	ME4LA4	MX4LA4	29500	36900	66500	87500	20500	320		
10.5	6210	2.6	139	309L3	—	BE132MA4	BX132MA4	—	—	—	—	68000	87500	16400	334		
11.3	5610	0.9	129	—	305R4	BE132MA4	BX132MA4	ME4LA4	MX4LA4	20200	23000	39000	46300	10700	298		
11.6	5630	2.3	126	307L3	—	BE132MA4	BX132MA4	ME4LA4	MX4LA4	28600	35700	64600	84900	19900	320		
11.6	5630	2.9	126	309L3	—	BE132MA4	BX132MA4	—	—	—	—	66000	84900	15900	334		
12.0	5420	1.4	121	306L3	—	BE132MA4	BX132MA4	ME4LA4	MX4LA4	23500	26800	53900	62200	15300	308		
12.2	5360	1.6	120	—	307R3	BE132MA4	BX132MA4	ME4LA4	MX4LA4	28100	35100	63600	83700	19600	322		
12.2	5360	2.4	120	—	309R3	BE132MA4	BX132MA4	—	—	—	—	65000	83700	15600	332		
12.3	5330	1.2	119	—	306R3	BE132MA4	BX132MA4	ME4LA4	MX4LA4	23400	26600	53600	61900	15200	310		
12.9	5070	2.1	113	307L3	—	BE132MA4	BX132MA4	ME4LA4	MX4LA4	27600	34500	62600	82300	19200	320		
13.0	5020	1.5	112	306L3	—	BE132MA4	BX132MA4	ME4LA4	MX4LA4	22900	26100	52700	60800	14900	308		
14.0	4670	1.1	105	305L3	—	BE132MA4	BX132MA4	ME4LA4	MX4LA4	18800	21500	36600	43400	9970	296		
14.0	4660	1.9	104	306L3	—	BE132MA4	BX132MA4	ME4LA4	MX4LA4	22300	25500	51500	59500	14500	308		
14.6	4490	2.8	100	307L3	—	BE132MA4	BX132MA4	ME4LA4	MX4LA4	26500	33100	60300	79300	18400	320		
14.7	4430	1.9	99.0	—	307R3	BE132MA4	BX132MA4	ME4LA4	MX4LA4	26400	32900	60100	79000	18300	322		
14.7	4430	2.9	99.0	—	309R3	BE132MA4	BX132MA4	—	—	—	—	61400	79000	14700	332		
14.8	4410	1.5	98.5	—	306R3	BE132MA4	BX132MA4	ME4LA4	MX4LA4	21900	25000	50700	58500	14200	310		
15.7	4160	2.9	93.0	307L3	—	BE132MA4	BX132MA4	ME4LA4	MX4LA4	25800	32300	59000	77600	18000	320		
16.2	4030	1.1	90.2	305L3	—	BE132MA4	BX132MA4	ME4LA4	MX4LA4	17900	20400	35100	41500	9490	296		
16.5	3950	2.2	88.3	306L3	—	BE132MA4	BX132MA4	ME4LA4	MX4LA4	21100	24100	49000	56600	13700	308		
17.2	3790	2.0	84.7	—	306R3	BE132MA4	BX132MA4	ME4LA4	MX4LA4	20900	23800	48400	55900	13600	310		
17.5	3730	2.8	83.4	—	307R3	BE132MA4	BX132MA4	ME4LA4	MX4LA4	24900	31100	57100	75100	17300	322		
17.8	3660	1.9	81.9	306L3	—	BE132MA4	BX132MA4	ME4LA4	MX4LA4	20600	23500	47900	55300	13400	308		
18.1	3600	2.8	80.6	307L3	—	BE132MA4	BX132MA4	ME4LA4	MX4LA4	24600	30800	56500	74300	17100	320		
18.5	3520	1.2	78.7	—	305R3	BE132MA4	BX132MA4	ME4LA4	MX4LA4	17100	19500	33600	39900	9070	298		
18.9	3450	1.0	77.2	304L3	—	BE132MA4	BX132MA4	ME4LA4	MX4LA4	17000	19400	33500	39700	9010	284		

A

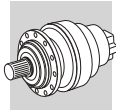

$P_1 = 7.5 \text{ kW}$

n ₂ min ⁻¹	M ₂ Nm	S	i	Motor		IE2		IE3		Rn ₂ [N]					Icon
				IE2	IE3	IE2	IE3	MC	MZ	HC/PC	HZ/PZ	FZ			
18.9	3450	1.4	77.2	305L3	—	BE132MA4	BX132MA4	ME4LA4	MX4LA4	17000	19400	33500	39700	9010	296
19.0	3440	2.4	77.0	306L3	—	BE132MA4	BX132MA4	ME4LA4	MX4LA4	20200	23000	47000	54300	13100	308
19.9	3280	1.1	73.3	—	305R3	BE132MA4	BX132MA4	ME4LA4	MX4LA4	16700	19100	32900	39000	8850	298
20.0	3260	2.3	72.9	—	306R3	BE132MA4	BX132MA4	ME4LA4	MX4LA4	19800	22600	46300	53400	12900	310
20.1	3340	1.6	72.5	306L2	—	BE132MA4	BX132MA4	ME4LA4	MX4LA4	19800	22600	46200	53300	12900	308
20.2	3230	1.0	72.3	304L3	—	BE132MA4	BX132MA4	ME4LA4	MX4LA4	16600	19000	32800	38900	8810	284
20.2	3230	1.3	72.3	305L3	—	BE132MA4	BX132MA4	ME4LA4	MX4LA4	16600	19000	32800	38900	8810	296
21.6	3020	2.4	67.5	—	306R3	BE132MA4	BX132MA4	ME4LA4	MX4LA4	19300	22000	45200	52200	12600	310
22.4	2920	2.6	65.2	306L3	—	BE132MA4	BX132MA4	ME4LA4	MX4LA4	19100	21800	44800	51700	12400	308
23.1	2820	1.0	63.1	—	304R3	BE132MA4	BX132MA4	—	—	15900	18100	31500	37300	8420	286
23.1	2820	1.5	63.1	—	305R3	BE132MA4	BX132MA4	ME4LA4	MX4LA4	15900	18100	31500	37300	8420	298
23.2	2820	1.2	63.1	304L3	—	BE132MA4	BX132MA4	ME4LA4	MX4LA4	15900	18100	31500	37300	8420	284
23.2	2820	1.7	63.1	305L3	—	BE132MA4	BX132MA4	ME4LA4	MX4LA4	15900	18100	31500	37300	8420	296
25.1	2600	2.9	58.1	—	306R3	BE132MA4	BX132MA4	ME4LA4	MX4LA4	18400	21000	43200	49900	11900	310
26.0	2590	2.0	56.3	306L2	—	BE132MA4	BX132MA4	ME4LA4	MX4LA4	18200	20700	42800	49400	11800	308
26.2	2570	1.4	55.8	305L2	—	BE132MA4	BX132MA4	ME4LA4	MX4LA4	15200	17400	30300	36000	8080	296
26.9	2420	1.5	54.2	—	305R3	BE132MA4	BX132MA4	ME4LA4	MX4LA4	15100	17200	30100	35700	8010	298
27.3	2390	0.9	53.4	303L3	—	BE132MA4	BX132MA4	ME4LA4	MX4LA4	15000	17200	30000	35500	7970	272
27.3	2390	1.4	53.4	304L3	—	BE132MA4	BX132MA4	ME4LA4	MX4LA4	15000	17200	30000	35500	7970	284
27.3	2390	1.7	53.4	305L3	—	BE132MA4	BX132MA4	ME4LA4	MX4LA4	15000	17200	30000	35500	7970	296
29.0	2250	1.1	50.3	—	303R3	BE132MA4	BX132MA4	—	—	14700	16800	29400	34900	7810	274
29.0	2250	1.5	50.3	—	304R3	BE132MA4	BX132MA4	—	—	14700	16800	29400	34900	7810	286
29.0	2250	2.0	50.3	—	305R3	BE132MA4	BX132MA4	ME4LA4	MX4LA4	14700	16800	29400	34900	7810	298
31	2080	1.0	46.6	—	303R3	BE132MA4	BX132MA4	—	—	14400	16400	28800	34100	7610	274
31	2180	1.1	47.3	304L2	—	BE132MA4	BX132MA4	ME4LA4	MX4LA4	14400	16500	28900	34200	7650	284
31	2080	1.4	46.6	—	304R3	BE132MA4	BX132MA4	—	—	14400	16400	28800	34100	7610	286
31	2080	2.1	46.6	—	305R3	BE132MA4	BX132MA4	ME4LA4	MX4LA4	14400	16400	28800	34100	7610	298
33	1950	1.6	43.6	304L3	—	BE132MA4	BX132MA4	ME4LA4	MX4LA4	14000	16000	28200	33400	7450	284
33	2060	1.7	44.6	305L2	—	BE132MA4	BX132MA4	ME4LA4	MX4LA4	14100	16200	28400	33600	7500	296
34	1900	1.1	42.6	—	303R3	BE132MA4	BX132MA4	—	—	13900	15900	28000	33200	7390	274
34	1900	1.7	42.6	—	304R3	BE132MA4	BX132MA4	—	—	13900	15900	28000	33200	7390	286
34	1900	2.0	42.6	—	305R3	BE132MA4	BX132MA4	ME4LA4	MX4LA4	13900	15900	28000	33200	7390	298
38	1770	1.2	38.4	303L2	—	BE132MA4	BX132MA4	ME4LA4	MX4LA4	13500	15400	27100	32200	7140	272
38	1770	1.6	38.4	304L2	—	BE132MA4	BX132MA4	ME4LA4	MX4LA4	13500	15400	27100	32200	7140	284
38	1770	2.4	38.4	305L2	—	BE132MA4	BX132MA4	ME4LA4	MX4LA4	13500	15400	27100	32200	7140	296
39	1670	1.0	37.3	—	301R3	BE132MA4	BX132MA4	—	—	4120	4120	14300	15600	2360	264
39	1660	1.4	37.1	—	303R3	BE132MA4	BX132MA4	—	—	13300	15200	26900	31800	7060	274
39	1660	2.1	37.1	—	304R3	BE132MA4	BX132MA4	—	—	13300	15200	26900	31800	7060	286
39	1660	2.6	37.1	—	305R3	BE132MA4	BX132MA4	ME4LA4	MX4LA4	13300	15200	26900	31800	7060	298
41	1650	1.1	35.8	303L2	—	BE132MA4	BX132MA4	ME4LA4	MX4LA4	13100	15000	26600	31500	6970	272
41	1650	2.2	35.8	305L2	—	BE132MA4	BX132MA4	ME4LA4	MX4LA4	13100	15000	26600	31500	6970	296
46	1410	1.5	31.5	—	303R3	BE132MA4	BX132MA4	—	—	12600	14400	25600	30300	6680	274
46	1410	2.2	31.5	—	304R3	BE132MA4	BX132MA4	—	—	12600	14400	25600	30300	6680	286
46	1410	2.7	31.5	—	305R3	BE132MA4	BX132MA4	ME4LA4	MX4LA4	12600	14400	25600	30300	6680	298
47	1420	1.5	30.8	303L2	—	BE132MA4	BX132MA4	ME4LA4	MX4LA4	12500	14300	25400	30100	6630	272
47	1420	2.0	30.8	304L2	—	BE132MA4	BX132MA4	ME4LA4	MX4LA4	12500	14300	25400	30100	6630	284
48	1420	1.1	30.7	301L2	—	BE132MA4	BX132MA4	ME4LA4	MX4LA4	3870	3870	13500	14700	2210	262
48	1360	1.2	30.4	—	301R3	BE132MA4	BX132MA4	—	—	3850	3850	13400	14700	2200	264
55	1220	1.5	26.4	303L2	—	BE132MA4	BX132MA4	ME4LA4	MX4LA4	11900	13600	24300	28700	6300	272
55	1220	2.9	26.4	305L2	—	BE132MA4	BX132MA4	ME4LA4	MX4LA4	11900	13600	24300	28700	6300	296
57	1150	1.8	25.7	—	303R3	BE132MA4	BX132MA4	—	—	11800	13400	24000	28500	6240	274
57	1150	2.6	25.7	—	304R3	BE132MA4	BX132MA4	—	—	11800	13400	24000	28500	6240	286
59	1130	1.3	24.6	301L2	—	BE132MA4	BX132MA4	ME4LA4	MX4LA4	3590	3590	12600	13800	2050	262
59	1110	1.3	24.8	—	301R3	BE132MA4	BX132MA4	—	—	3600	3600	12600	13800	2060	264
60	1130	1.9	24.5	303L2	—	BE132MA4	BX132MA4	ME4LA4	MX4LA4	11600	13200	23700	28100	6150	272
60	1130	2.9	24.5	304L2	—	BE132MA4	BX132MA4	ME4LA4	MX4LA4	11600	13200	23700	28100	6150	284
64	1050	2.0	22.7	303L2	—	BE132MA4	BX132MA4	ME4LA4	MX4LA4	11300	12900	23200	27500	5990	272
64	1050	2.7	22.7	304L2	—	BE132MA4	BX132MA4	ME4LA4	MX4LA4	11300	12900	23200	27500	5990	284
70	960	1.9	20.8	303L2	—	BE132MA4	BX132MA4	ME4LA4	MX4LA4	11000	12500	22600	26700	5820	272
73	930	1.4	20.1	301L2	—	BE132MA4	BX132MA4	ME4LA4	MX4LA4	3360	3360	11900	13000	1920	262
76	890	1.8	19.2	—	303R2	BE132MA4	BX132MA4	ME4LA4	MX4LA4	10700	12200	22000	26100	5670	274
80	840	0.9	18.2	300L2	—	BE132MA4	BX132MA4	ME4LA4	MX4LA4	3250	3250	11500	13400	1850	252
80	840	1.6	18.2	301L2	—	BE132MA4	BX132MA4	ME4LA4	MX4LA4	3250	3250	11500	12600	1850	262
81	840	2.4	18.1	303L2	—	BE132MA4	BX132MA4	ME4LA4	MX4LA4	10500	12000	21700	25700	5560	272
92	730	2.5	15.9	—	303R2	BE132MA4	BX132MA4	ME4LA4	MX4LA4	10000	11500	20800	24700	5320	274

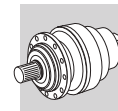

$P_1 = 7.5 \text{ kW}$

n ₂ min ⁻¹	M ₂ Nm	S	i	Motor Configurations		IE2 IE3				Rn ₂ [N]					MC	MZ	HC/PC	HZ/PZ	FZ	Icon
				303L2	300L2	IE2	IE3	IE2	IE3	MC	MZ	HC/PC	HZ/PZ	FZ						
95	710	2.4	15.3	303L2	—	BE132MA4	BX132MA4	ME4LA4	MX4LA4	9910	11300	20600	24400	5260	272					
98	680	1.1	14.8	300L2	—	BE132MA4	BX132MA4	ME4LA4	MX4LA4	3030	3030	10800	12600	1730	252					
98	680	1.9	14.8	301L2	—	BE132MA4	BX132MA4	ME4LA4	MX4LA4	3030	3030	10800	11800	1730	262					
99	680	1.4	14.8	—	301R2	BE132MA4	BX132MA4	ME4LA4	MX4LA4	3030	3030	10800	11800	1730	264					
117	580	2.9	12.5	303L2	—	BE132MA4	BX132MA4	ME4LA4	MX4LA4	9260	10600	19400	23000	4910	272					
121	560	1.2	12.1	300L2	—	BE132MA4	BX132MA4	ME4LA4	MX4LA4	2830	2830	10200	11800	1620	252					
121	560	2.2	12.1	301L2	—	BE132MA4	BX132MA4	ME4LA4	MX4LA4	2830	2830	10200	11100	1620	262					
123	550	1.1	11.8	—	300R2	BE132MA4	BX132MA4	ME4LA4	MX4LA4	2810	2810	10100	11800	1610	254					
123	550	2.1	11.8	—	301R2	BE132MA4	BX132MA4	ME4LA4	MX4LA4	2810	2810	10100	11100	1610	264					
151	460	1.7	9.67	303L1	—	BE132MA4	BX132MA4	ME4LA4	MX4LA4	8500	9710	17900	21300	4510	272					
162	430	1.5	9.00	301L1	—	BE132MA4	BX132MA4	ME4LA4	MX4LA4	2570	2570	9320	10200	1470	262					
167	400	1.5	8.74	—	300R2	BE132MA4	BX132MA4	ME4LA4	MX4LA4	2540	2540	9240	10700	1450	254					
167	400	2.7	8.74	—	301R2	BE132MA4	BX132MA4	ME4LA4	MX4LA4	2540	2540	9240	10100	1450	264					
203	340	1.2	7.20	300L1	—	BE132MA4	BX132MA4	ME4LA4	MX4LA4	2380	2380	8720	10100	1360	252					
203	340	2.2	7.20	301L1	—	BE132MA4	BX132MA4	ME4LA4	MX4LA4	2380	2380	8720	9530	1360	262					
205	330	1.8	7.13	—	300R2	BE132MA4	BX132MA4	ME4LA4	MX4LA4	2380	2380	8690	10100	1360	254					
253	270	1.7	5.77	300L1	—	BE132MA4	BX132MA4	ME4LA4	MX4LA4	2210	2210	8160	9480	1260	252					
342	200	2.5	4.26	300L1	—	BE132MA4	BX132MA4	ME4LA4	MX4LA4	2000	2000	7450	8660	1140	252					
420	170	2.9	3.48	300L1	—	BE132MA4	BX132MA4	ME4LA4	MX4LA4	1870	1870	7010	8150	1070	252					

$P_1 = 9.2 \text{ kW}$

n ₂ min ⁻¹	M ₂ Nm	S	i	Motor Configurations		IE2 IE3				Rn ₂ [N]					MC	MZ	HC/PC	HZ/PZ	FZ	Icon
				317ML4	316ML4	IE2	IE3	IE2	IE3	MC	MZ	HC/PC	HZ/PZ	FZ						
0.77	100500	1.5	1893	317ML4	—	BE132MB4	BX160MA4	—	—	—	—	410500	436100	150000	414					
0.92	84700	1.8	1595	317ML4	—	BE132MB4	BX160MA4	—	—	—	—	400600	425500	150000	414					
0.94	82500	1.5	1553	316ML4	—	BE132MB4	BX160MA4	—	—	—	—	256500	287700	150000	404					
0.98	79300	1.0	1492	315ML4	—	BE132MB4	BX160MA4	—	—	—	—	166600	199800	90000	392					
1.1	67900	1.1	1277	314ML4	—	BE132MB4	BX160MA4	—	—	—	—	163000	195500	86100	380					
1.1	68200	1.3	1284	315ML4	—	BE132MB4	BX160MA4	—	—	—	—	163100	195600	86200	392					
1.1	69500	1.7	1308	316ML4	—	BE132MB4	BX160MA4	—	—	—	—	250300	280700	144600	404					
1.1	70000	2.2	1318	317ML4	—	BE132MB4	BX160MA4	—	—	—	—	389800	414100	145000	414					
1.2	65700	1.8	1237	316ML4	—	BE132MB4	BX160MA4	—	—	—	—	248300	278500	142000	404					
1.3	58400	1.2	1099	314ML4	—	BE132MB4	BX160MA4	—	—	—	—	159500	191300	81900	380					
1.3	58700	1.5	1104	315ML4	—	BE132MB4	BX160MA4	—	—	—	—	159600	191400	82000	392					
1.3	58700	2.0	1104	316ML4	—	BE132MB4	BX160MA4	—	—	—	—	244300	274000	136700	404					
1.3	60200	2.6	1134	317ML4	—	BE132MB4	BX160MA4	—	—	—	—	381500	405300	137900	414					
1.4	53900	1.0	1014	313ML4	—	BE132MB4	BX160MA4	—	—	—	—	169600	198800	70800	368					
1.4	55100	1.4	1038	314ML4	—	BE132MB4	BX160MA4	—	—	—	—	158200	189700	80300	380					
1.4	55400	1.8	1043	315ML4	—	BE132MB4	BX160MA4	—	—	—	—	158300	189900	80400	392					
1.4	54200	2.2	1020	316ML4	—	BE132MB4	BX160MA4	—	—	—	—	241500	270900	133100	404					
1.5	50600	2.8	953	—	317MR4	BE132MB4	BX160MA4	—	—	—	—	372200	395400	130100	416					
1.6	47200	1.1	889	313ML4	—	BE132MB4	BX160MA4	—	—	—	—	166500	195100	67800	368					
1.6	49200	1.4	926	314ML4	—	BE132MB4	BX160MA4	—	—	—	—	155700	186700	77300	380					
1.6	49400	1.8	930	315ML4	—	BE132MB4	BX160MA4	—	—	—	—	155800	186800	77500	392					
1.6	48300	1.5	909	—	315MR4	BE132MB4	BX160MA4	—	—	—	—	155300	186200	76900	394					
1.7	45600	1.6	858	314ML4	—	BE132MB4	BX160MA4	—	—	—	—	154000	184600	75400	380					
1.7	45800	2.1	862	315ML4	—	BE132MB4	BX160MA4	—	—	—	—	154100	184800	75500	392					
1.7	46700	2.5	880	316ML4	—	BE132MB4	BX160MA4	—	—	—	—	236500	265300	126700	404					
1.8	43800	1.0	825	311ML4	—	BE132MB4	BX160MA4	—	—	—	—	113700	116000	53700	356					
1.8	42000	1.2	790	313ML4	—	BE132MB4	BX160MA4	—	—	—	—	163700	191800	65200	368					
1.9	41500	2.1	782	—	315MR4	BE132MB4	BX160MA4	—	—	—	—	152000	182200	73100	394					
1.9	41600	2.8	784	316ML4	—	BE132MB4	BX160MA4	—	—	—	—	232600	260900	121900	404					



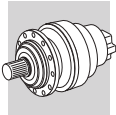

$P_1 = 9.2 \text{ kW}$

n ₂ min ⁻¹	M ₂ Nm	S	i	IE2		IE3		IE2		IE3		Rn ₂ [N]					
				MC	MZ	HC/PC	HZ/PZ	FZ									
1.9	41500	2.8	782	—	316MR4	BE132MB4	BX160MA4	—	—	—	—	232500	260900	121800	406		
2.0	39200	1.9	738	314ML4	—	BE132MB4	BX160MA4	—	—	—	—	150700	180700	71700	380		
2.0	39400	2.4	741	315ML4	—	BE132MB4	BX160MA4	—	—	—	—	150800	180800	71800	392		
2.1	36900	1.4	695	313ML4	—	BE132MB4	BX160MA4	—	—	—	—	160700	188300	62500	368		
2.2	35500	2.2	668	314ML4	—	BE132MB4	BX160MA4	—	—	—	—	148600	178200	69400	380		
2.2	35700	2.7	672	315ML4	—	BE132MB4	BX160MA4	—	—	—	—	148700	178300	69500	392		
2.2	35000	2.4	659	—	315MR4	BE132MB4	BX160MA4	—	—	—	—	148300	177800	69000	394		
2.3	33300	1.3	627	311ML4	—	BE132MB4	BX160MA4	—	—	—	—	109300	111500	49000	356		
2.3	33400	1.2	629	—	311MR4	BE132MB4	BX160MA4	—	—	—	—	109300	111600	49100	358		
2.3	33600	1.5	633	313ML4	—	BE132MB4	BX160MA4	—	—	—	—	158600	185800	60500	368		
2.3	34300	1.4	647	—	313MR4	BE132MB4	BX160MA4	—	—	—	—	159100	186400	61000	370		
2.3	33100	2.9	623	—	315MR4	BE132MB4	BX160MA4	—	—	—	—	147100	176400	67800	394		
2.4	32600	1.7	614	—	314MR4	BE132MB4	BX160MA4	—	—	—	—	146800	176000	67400	382		
2.5	30500	2.2	575	314ML4	—	BE132MB4	BX160MA4	—	—	—	—	145400	174400	66000	380		
2.5	31200	2.3	588	314ML4	—	BE132MB4	BX160MA4	—	—	—	—	145900	174900	66500	380		
2.6	30200	1.4	568	311ML4	—	BE132MB4	BX160MA4	—	—	—	—	107800	110000	47400	356		
2.6	29900	1.8	564	313ML4	—	BE132MB4	BX160MA4	—	—	—	—	156000	182800	58300	368		
2.7	28400	1.7	535	—	313MR4	BE132MB4	BX160MA4	—	—	—	—	154800	181400	57200	370		
2.8	27500	0.9	517	—	310MR4	BE132MB4	BX160MA4	—	—	—	—	84600	107300	46000	346		
2.8	27600	1.5	520	—	311MR4	BE132MB4	BX160MA4	—	—	—	—	106400	108600	46100	358		
2.8	27300	1.7	514	313ML4	—	BE132MB4	BX160MA4	—	—	—	—	153900	180400	56500	368		
2.8	28000	2.4	528	—	314MR4	BE132MB4	BX160MA4	—	—	—	—	143700	172300	64100	382		
2.9	26900	0.9	507	310ML4	—	BE132MB4	BX160MA4	—	—	—	—	84400	107000	45700	344		
2.9	27200	1.7	512	311ML4	—	BE132MB4	BX160MA4	—	—	—	—	106200	108400	45800	356		
2.9	26400	1.8	496	—	313MR4	BE132MB4	BX160MA4	—	—	—	—	153200	179500	55800	370		
3.0	26000	1.2	490	—	311MR4	BE132MB4	BX160MA4	—	—	—	—	105500	107700	45200	358		
3.0	26300	2.9	495	314ML4	—	BE132MB4	BX160MA4	—	—	—	—	142300	170700	62700	380		
3.2	24100	1.2	453	310ML4	—	BE132MB4	BX160MA4	—	—	—	—	83100	105300	44000	344		
3.2	24000	2.4	452	313ML4	—	BE132MB4	BX160MA4	—	—	—	—	151100	177100	54100	368		
3.2	23900	1.9	450	—	313MR4	BE132MB4	BX160MA4	—	—	—	—	151100	177000	54100	370		
3.3	23300	1.7	438	—	311MR4	BE132MB4	BX160MA4	—	—	—	—	103800	106000	43500	358		
3.3	23600	2.5	445	—	314MR4	BE132MB4	BX160MA4	—	—	—	—	140200	168100	60600	382		
3.5	21900	1.8	413	—	311MR4	BE132MB4	BX160MA4	—	—	—	—	103000	105100	42700	358		
3.6	21800	2.1	410	311ML4	—	BE132MB4	BX160MA4	—	—	—	—	102900	105000	42600	356		
3.7	20800	0.9	392	310ML4	—	BE132MB4	BX160MA4	—	—	—	—	81300	103100	41900	344		
3.7	20900	2.7	394	313ML4	—	BE132MB4	BX160MA4	—	—	—	—	148200	173700	51700	368		
3.8	20300	1.2	383	—	310MR4	BE132MB4	BX160MA4	—	—	—	—	81100	102800	41600	346		
3.8	20600	2.2	387	—	313MR4	BE132MB4	BX160MA4	—	—	—	—	147900	173300	51400	370		
4.2	18500	1.1	349	309L4	—	BE132MB4	BX160MA4	—	—	—	—	70800	91100	22300	334		
4.2	19200	1.0	350	310ML3	—	BE132MB4	BX160MA4	—	—	—	—	80100	101500	40400	344		
4.2	18400	1.6	347	—	310MR4	BE132MB4	BX160MA4	—	—	—	—	79900	101400	40200	346		
4.2	18500	2.5	348	311ML4	—	BE132MB4	BX160MA4	—	—	—	—	100500	102500	40300	356		
4.3	18100	2.1	341	—	311MR4	BE132MB4	BX160MA4	—	—	—	—	100200	102300	40000	358		
4.4	17600	1.0	331	—	309R4	BE132MB4	BX160MA4	—	—	—	—	70300	90400	22000	332		
4.7	16400	2.7	309	—	313MR4	BE132MB4	BX160MA4	—	—	—	—	143100	167700	47700	370		
4.8	16200	1.4	305	—	310MR4	BE132MB4	BX160MA4	—	—	—	—	78500	99500	38600	346		
4.8	16600	1.8	304	313ML3	—	BE132MB4	BX160MA4	—	—	—	—	142800	167300	47400	368		
4.9	16200	1.4	295	310ML3	—	BE132MB4	BX160MA4	—	—	—	—	78100	99100	38200	344		
5.0	15900	1.7	291	311ML3	—	BE132MB4	BX160MA4	—	—	—	—	98000	100000	38000	356		

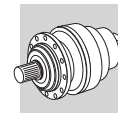

$P_1 = 9.2 \text{ kW}$

n ₂ min ⁻¹	M ₂ Nm	S	i	IE2		IE3		IE2		IE3		Rn ₂ [N]					📄
				MC	MZ	HC/PC	HZ/PZ	FZ									
5.0	15600	2.4	294	—	311MR4	BE132MB4	BX160MA4	—	—	—	—	98100	100100	38100	358		
5.1	15500	1.0	284	309L3	—	BE132MB4	BX160MA4	—	—	—	—	69000	88800	20800	334		
5.1	15100	1.1	284	—	309R4	BE132MB4	BX160MA4	—	—	—	—	69000	88800	20900	332		
5.3	14700	1.9	276	—	310MR4	BE132MB4	BX160MA4	—	—	—	—	78000	98900	37300	346		
5.7	13700	1.1	258	—	307R4	BE132MB4	BX160MA4	—	—	30000	37500	67500	88800	25300	322		
5.7	13700	1.3	258	—	309R4	BE132MB4	BX160MA4	—	—	—	—	69000	88800	20200	332		
5.7	13700	1.6	258	—	310MR4	BE132MB4	BX160MA4	—	—	—	—	78000	98900	36500	346		
5.9	13600	1.3	249	310ML3	—	BE132MB4	BX160MA4	—	—	—	—	78000	98900	36100	344		
6.0	13400	2.7	245	311ML3	—	BE132MB4	BX160MA4	—	—	—	—	98000	100000	35900	356		
6.1	13100	1.0	239	309L3	—	BE132MB4	BX160MA4	—	—	—	—	69000	88800	19700	334		
6.1	12600	2.3	238	—	310MR4	BE132MB4	BX160MA4	—	—	—	—	78000	98900	35500	346		
6.3	12300	0.9	232	—	307R4	BE132MB4	BX160MA4	—	—	30000	37500	67500	88800	24400	322		
6.3	12300	1.4	232	—	309R4	BE132MB4	BX160MA4	—	—	—	—	69000	88800	19500	332		
6.3	12600	1.5	230	310ML3	—	BE132MB4	BX160MA4	—	—	—	—	78000	98900	35100	344		
6.6	12100	1.1	221	307L3	—	BE132MB4	BX160MA4	ME4LB4	MX5SA4	30000	37500	67500	88800	24000	320		
6.6	12200	1.1	223	309L3	—	BE132MB4	BX160MA4	—	—	—	—	69000	88800	19200	334		
7.1	10900	1.3	206	—	307R4	BE132MB4	BX160MA4	—	—	30000	37500	67500	88800	23400	322		
7.1	10900	1.8	206	—	309R4	BE132MB4	BX160MA4	—	—	—	—	69000	88800	18700	332		
7.1	10900	2.0	206	—	310MR4	BE132MB4	BX160MA4	—	—	—	—	78000	98900	33800	346		
7.2	11000	1.0	202	307L3	—	BE132MB4	BX160MA4	ME4LB4	MX5SA4	30000	37500	67500	88800	23300	320		
7.2	11000	1.5	202	309L3	—	BE132MB4	BX160MA4	—	—	—	—	69000	88800	18600	334		
7.2	11100	2.0	202	310ML3	—	BE132MB4	BX160MA4	—	—	—	—	78000	98900	33600	344		
7.7	10100	1.4	191	—	307R4	BE132MB4	BX160MA4	—	—	30000	37500	67500	88800	22800	322		
7.7	10100	1.7	191	—	309R4	BE132MB4	BX160MA4	—	—	—	—	69000	88800	18300	332		
7.7	10100	2.7	189	—	310MR4	BE132MB4	BX160MA4	—	—	—	—	78000	98900	32900	346		
8.0	10000	1.4	183	309L3	—	BE132MB4	BX160MA4	—	—	—	—	69000	88800	18000	334		
8.1	9610	1.0	181	—	306R4	BE132MB4	BX160MA4	ME4LB4	MX5SA4	25000	28500	57000	65800	17500	310		
8.2	9690	1.3	177	307L3	—	BE132MB4	BX160MA4	ME4LB4	MX5SA4	30000	37500	67500	88800	22300	320		
8.2	9710	1.8	177	310ML3	—	BE132MB4	BX160MA4	—	—	—	—	78000	98900	32200	344		
8.8	8770	1.2	165	—	307R4	BE132MB4	BX160MA4	—	—	30000	37500	67500	88800	21800	322		
8.8	8770	1.9	165	—	309R4	BE132MB4	BX160MA4	—	—	—	—	69000	88800	17400	332		
8.9	8960	3.0	164	310ML3	—	BE132MB4	BX160MA4	—	—	—	—	78000	98900	31300	344		
9.0	8850	1.2	162	307L3	—	BE132MB4	BX160MA4	ME4LB4	MX5SA4	30000	37500	67500	88800	21600	320		
9.0	8850	1.8	162	309L3	—	BE132MB4	BX160MA4	—	—	—	—	69000	88800	17300	334		
9.2	8380	1.1	158	—	306R4	BE132MB4	BX160MA4	ME4LB4	MX5SA4	25000	28500	57000	65800	16700	310		
9.6	8320	0.9	152	306L3	—	BE132MB4	BX160MA4	ME4LB4	MX5SA4	25000	28500	57000	65800	16500	308		
9.6	8070	1.7	152	—	307R4	BE132MB4	BX160MA4	—	—	30000	37500	67500	88800	21200	322		
9.6	8070	2.3	152	—	309R4	BE132MB4	BX160MA4	—	—	—	—	69000	88800	16900	332		
9.8	8180	2.7	149	310ML3	—	BE132MB4	BX160MA4	—	—	—	—	78000	98900	30400	344		
10.0	8010	1.7	146	307L3	—	BE132MB4	BX160MA4	ME4LB4	MX5SA4	30000	37500	67500	88800	20900	320		
10.4	7720	1.0	141	306L3	—	BE132MB4	BX160MA4	ME4LB4	MX5SA4	24700	28200	56400	65100	16100	308		
10.5	7600	1.4	139	307L3	—	BE132MB4	BX160MA4	ME4LB4	MX5SA4	29500	36900	66500	87500	20500	320		
10.5	7600	2.1	139	309L3	—	BE132MB4	BX160MA4	—	—	—	—	68000	87500	16400	334		
11.6	6890	1.9	126	307L3	—	BE132MB4	BX160MA4	ME4LB4	MX5SA4	28600	35700	64600	84900	19900	320		
11.6	6890	2.4	126	309L3	—	BE132MB4	BX160MA4	—	—	—	—	66000	84900	15900	334		
12.0	6640	1.2	121	306L3	—	BE132MB4	BX160MA4	ME4LB4	MX5SA4	23500	26800	53900	62200	15300	308		
12.2	6560	1.3	120	—	307R3	BE132MB4	BX160MA4	ME4LB4	MX5SA4	28100	35100	63600	83700	19600	322		
12.2	6560	2.0	120	—	309R3	BE132MB4	BX160MA4	—	—	—	—	65000	83700	15600	332		

A

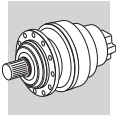

$P_1 = 9.2 \text{ kW}$

n_2 min ⁻¹	M_2 Nm	S	i	[Icon]		[Icon]		[Icon]		R _{n2} [N]					[Icon]
				IE2	IE3	IE2	IE3	MC	MZ	HC/PC	HZ/PZ	FZ			
12.2	6560	2.6	120	—	310MR3	BE132MB4	BX160MA4	—	—	—	—	73500	93200	28200	346
12.3	6530	1.0	119	—	306R3	BE132MB4	BX160MA4	ME4LB4	MX5SA4	23400	26600	53600	61900	15200	310
12.9	6200	1.7	113	307L3	—	BE132MB4	BX160MA4	ME4LB4	MX5SA4	27600	34500	62600	82300	19200	320
12.9	6200	2.5	113	309L3	—	BE132MB4	BX160MA4	—	—	—	—	63900	82300	15400	334
13.0	6150	1.2	112	306L3	—	BE132MB4	BX160MA4	ME4LB4	MX5SA4	22900	26100	52700	60800	14900	308
14.0	5710	1.6	104	306L3	—	BE132MB4	BX160MA4	ME4LB4	MX5SA4	22300	25500	51500	59500	14500	308
14.6	5490	2.3	100	307L3	—	BE132MB4	BX160MA4	ME4LB4	MX5SA4	26500	33100	60300	79300	18400	320
14.7	5420	1.6	99.0	—	307R3	BE132MB4	BX160MA4	ME4LB4	MX5SA4	26400	32900	60100	79000	18300	322
14.7	5420	2.4	99.0	—	309R3	BE132MB4	BX160MA4	—	—	—	—	61400	79000	14700	332
14.7	5420	3.0	99.0	—	310MR3	BE132MB4	BX160MA4	—	—	—	—	69400	88000	26500	346
14.8	5390	1.2	98.5	—	306R3	BE132MB4	BX160MA4	ME4LB4	MX5SA4	21900	25000	50700	58500	14200	310
15.7	5090	2.4	93.0	307L3	—	BE132MB4	BX160MA4	ME4LB4	MX5SA4	25800	32300	59000	77600	18000	320
15.7	5090	3.0	93.0	309L3	—	BE132MB4	BX160MA4	—	—	—	—	60300	77600	14400	334
16.5	4830	1.8	88.3	306L3	—	BE132MB4	BX160MA4	ME4LB4	MX5SA4	21100	24100	49000	56600	13700	308
17.2	4640	1.6	84.7	—	306R3	BE132MB4	BX160MA4	ME4LB4	MX5SA4	20900	23800	48400	55900	13600	310
17.5	4570	2.2	83.4	—	307R3	BE132MB4	BX160MA4	ME4LB4	MX5SA4	24900	31100	57100	75100	17300	322
17.8	4480	1.5	81.9	306L3	—	BE132MB4	BX160MA4	ME4LB4	MX5SA4	20600	23500	47900	55300	13400	308
18.1	4410	2.3	80.6	307L3	—	BE132MB4	BX160MA4	ME4LB4	MX5SA4	24600	30800	56500	74300	17100	320
18.5	4310	1.0	78.7	—	305R3	BE132MB4	BX160MA4	ME4LB4	MX5SA4	17100	19500	33600	39900	9070	298
18.6	4310	2.6	78.6	—	307R3	BE132MB4	BX160MA4	ME4LB4	MX5SA4	24400	30500	56100	73800	17000	322
18.9	4230	1.1	77.2	305L3	—	BE132MB4	BX160MA4	ME4LB4	MX5SA4	17000	19400	33500	39700	9010	296
19.0	4220	2.0	77.0	306L3	—	BE132MB4	BX160MA4	ME4LB4	MX5SA4	20200	23000	47000	54300	13100	308
19.7	4060	2.9	74.1	307L3	—	BE132MB4	BX160MA4	ME4LB4	MX5SA4	23900	29900	55100	72500	16700	320
20.0	3990	1.9	72.9	—	306R3	BE132MB4	BX160MA4	ME4LB4	MX5SA4	19800	22600	46300	53400	12900	310
20.1	4090	1.3	72.5	306L2	—	BE132MB4	BX160MA4	ME4LB4	MX5SA4	19800	22600	46200	53300	12900	308
20.2	3960	1.1	72.3	305L3	—	BE132MB4	BX160MA4	ME4LB4	MX5SA4	16600	19000	32800	38900	8810	296
20.3	3930	2.6	71.8	—	307R3	BE132MB4	BX160MA4	ME4LB4	MX5SA4	23700	29600	54500	71800	16500	322
21.6	3700	1.9	67.5	—	306R3	BE132MB4	BX160MA4	ME4LB4	MX5SA4	19300	22000	45200	52200	12600	310
22.4	3570	2.1	65.2	306L3	—	BE132MB4	BX160MA4	ME4LB4	MX5SA4	19100	21800	44800	51700	12400	308
23.1	3450	1.3	63.1	—	305R3	BE132MB4	BX160MA4	ME4LB4	MX5SA4	15900	18100	31500	37300	8420	298
23.2	3450	1.0	63.1	304L3	—	BE132MB4	BX160MA4	ME4LB4	MX5SA4	15900	18100	31500	37300	8420	284
23.2	3450	1.4	63.1	305L3	—	BE132MB4	BX160MA4	ME4LB4	MX5SA4	15900	18100	31500	37300	8420	296
25.1	3180	2.4	58.1	—	306R3	BE132MB4	BX160MA4	ME4LB4	MX5SA4	18400	21000	43200	49900	11900	310
26.0	3180	1.6	56.3	306L2	—	BE132MB4	BX160MA4	ME4LB4	MX5SA4	18200	20700	42800	49400	11800	308
26.2	3150	1.1	55.8	305L2	—	BE132MB4	BX160MA4	ME4LB4	MX5SA4	15200	17400	30300	36000	8080	296
26.9	2970	1.2	54.2	—	305R3	BE132MB4	BX160MA4	ME4LB4	MX5SA4	15100	17200	30100	35700	8010	298
27.3	2920	1.1	53.4	304L3	—	BE132MB4	BX160MA4	ME4LB4	MX5SA4	15000	17200	30000	35500	7970	284
27.3	2920	1.4	53.4	305L3	—	BE132MB4	BX160MA4	ME4LB4	MX5SA4	15000	17200	30000	35500	7970	296
27.4	2920	2.5	53.2	306L3	—	BE132MB4	BX160MA4	ME4LB4	MX5SA4	17900	20400	42100	48600	11600	308
29.0	2750	1.3	50.3	—	304R3	BE132MB4	BX160MA4	—	—	14700	16800	29400	34900	7810	286
29.0	2750	1.6	50.3	—	305R3	BE132MB4	BX160MA4	ME4LB4	MX5SA4	14700	16800	29400	34900	7810	298
31	2550	1.1	46.6	—	304R3	BE132MB4	BX160MA4	—	—	14400	16400	28800	34100	7610	286
31	2550	1.7	46.6	—	305R3	BE132MB4	BX160MA4	ME4LB4	MX5SA4	14400	16400	28800	34100	7610	298
31	2630	2.5	46.5	306L2	—	BE132MB4	BX160MA4	ME4LB4	MX5SA4	17100	19500	40400	46700	11100	308
32	2530	3.0	46.3	—	306R3	BE132MB4	BX160MA4	ME4LB4	MX5SA4	17000	19400	40400	46600	11100	310
33	2390	1.3	43.6	304L3	—	BE132MB4	BX160MA4	ME4LB4	MX5SA4	14000	16000	28200	33400	7450	284
33	2520	1.4	44.6	305L2	—	BE132MB4	BX160MA4	ME4LB4	MX5SA4	14100	16200	28400	33600	7500	296
34	2330	1.4	42.6	—	304R3	BE132MB4	BX160MA4	—	—	13900	15900	28000	33200	7390	286

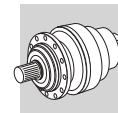

$P_1 = 9.2 \text{ kW}$

n ₂ min ⁻¹	M ₂ Nm	S	i	[Icons]		IE2		IE3		Rn ₂ [N]					[Icon]
				[Icon]	[Icon]	[Icon]	[Icon]	MC	MZ	HC/PC	HZ/PZ	FZ			
34	2330	1.6	42.6	—	305R3	BE132MB4	BX160MA4	ME4LB4	MX5SA4	13900	15900	28000	33200	7390	298
38	2170	1.0	38.4	303L2	—	BE132MB4	BX160MA4	ME4LB4	MX5SA4	13500	15400	27100	32200	7140	272
38	2170	1.3	38.4	304L2	—	BE132MB4	BX160MA4	ME4LB4	MX5SA4	13500	15400	27100	32200	7140	284
38	2170	2.0	38.4	305L2	—	BE132MB4	BX160MA4	ME4LB4	MX5SA4	13500	15400	27100	32200	7140	296
38	2170	3.0	38.4	306L2	—	BE132MB4	BX160MA4	ME4LB4	MX5SA4	16000	18300	38200	44100	10400	308
39	2030	1.2	37.1	—	303R3	BE132MB4	BX160MA4	—	—	13300	15200	26900	31800	7060	274
39	2030	1.7	37.1	—	304R3	BE132MB4	BX160MA4	—	—	13300	15200	26900	31800	7060	286
39	2030	2.1	37.1	—	305R3	BE132MB4	BX160MA4	ME4LB4	MX5SA4	13300	15200	26900	31800	7060	298
41	2020	0.9	35.8	303L2	—	BE132MB4	BX160MA4	ME4LB4	MX5SA4	13100	15000	26600	31500	6970	272
41	2020	1.8	35.8	305L2	—	BE132MB4	BX160MA4	ME4LB4	MX5SA4	13100	15000	26600	31500	6970	296
46	1720	1.2	31.5	—	303R3	BE132MB4	BX160MA4	—	—	12600	14400	25600	30300	6680	274
46	1720	1.8	31.5	—	304R3	BE132MB4	BX160MA4	—	—	12600	14400	25600	30300	6680	286
46	1720	2.2	31.5	—	305R3	BE132MB4	BX160MA4	ME4LB4	MX5SA4	12600	14400	25600	30300	6680	298
47	1740	1.2	30.8	303L2	—	BE132MB4	BX160MA4	ME4LB4	MX5SA4	12500	14300	25400	30100	6630	272
47	1740	1.6	30.8	304L2	—	BE132MB4	BX160MA4	ME4LB4	MX5SA4	12500	14300	25400	30100	6630	284
47	1740	2.5	30.8	305L2	—	BE132MB4	BX160MA4	ME4LB4	MX5SA4	12500	14300	25400	30100	6630	296
48	1730	0.9	30.7	301L2	—	BE132MB4	BX160MA4	ME4LB4	MX5SA4	3870	3870	13500	14700	2210	262
48	1670	1.0	30.4	—	301R3	BE132MB4	BX160MA4	—	—	3850	3850	13400	14700	2200	264
55	1490	1.2	26.4	303L2	—	BE132MB4	BX160MA4	ME4LB4	MX5SA4	11900	13600	24300	28700	6300	272
55	1490	2.4	26.4	305L2	—	BE132MB4	BX160MA4	ME4LB4	MX5SA4	11900	13600	24300	28700	6300	296
57	1410	1.5	25.7	—	303R3	BE132MB4	BX160MA4	—	—	11800	13400	24000	28500	6240	274
57	1410	2.2	25.7	—	304R3	BE132MB4	BX160MA4	—	—	11800	13400	24000	28500	6240	286
57	1410	2.6	25.7	—	305R3	BE132MB4	BX160MA4	ME4LB4	MX5SA4	11800	13400	24000	28500	6240	298
59	1390	1.1	24.6	301L2	—	BE132MB4	BX160MA4	ME4LB4	MX5SA4	3590	3590	12600	13800	2050	262
59	1360	1.0	24.8	—	301R3	BE132MB4	BX160MA4	—	—	3600	3600	12600	13800	2060	264
60	1380	1.6	24.5	303L2	—	BE132MB4	BX160MA4	ME4LB4	MX5SA4	11600	13200	23700	28100	6150	272
60	1380	2.4	24.5	304L2	—	BE132MB4	BX160MA4	ME4LB4	MX5SA4	11600	13200	23700	28100	6150	284
60	1380	2.8	24.5	305L2	—	BE132MB4	BX160MA4	ME4LB4	MX5SA4	11600	13200	23700	28100	6150	296
64	1280	1.6	22.7	303L2	—	BE132MB4	BX160MA4	ME4LB4	MX5SA4	11300	12900	23200	27500	5990	272
64	1280	2.2	22.7	304L2	—	BE132MB4	BX160MA4	ME4LB4	MX5SA4	11300	12900	23200	27500	5990	284
70	1170	1.6	20.8	303L2	—	BE132MB4	BX160MA4	ME4LB4	MX5SA4	11000	12500	22600	26700	5820	272
70	1170	2.5	20.8	304L2	—	BE132MB4	BX160MA4	ME4LB4	MX5SA4	11000	12500	22600	26700	5820	284
70	1170	2.8	20.8	305L2	—	BE132MB4	BX160MA4	ME4LB4	MX5SA4	11000	12500	22600	26700	5820	296
73	1130	1.1	20.1	301L2	—	BE132MB4	BX160MA4	ME4LB4	MX5SA4	3360	3360	11900	13000	1920	262
76	1080	1.4	19.2	—	303R2	BE132MB4	BX160MA4	ME4LB4	MX5SA4	10700	12200	22000	26100	5670	274
76	1080	2.6	19.2	—	305R2	BE132MB4	BX160MA4	ME4LB4	MX5SA4	10700	12200	22000	26100	5670	298
80	1030	1.3	18.2	301L2	—	BE132MB4	BX160MA4	ME4LB4	MX5SA4	3250	3250	11500	12600	1850	262
81	1020	2.0	18.1	303L2	—	BE132MB4	BX160MA4	ME4LB4	MX5SA4	10500	12000	21700	25700	5560	272
81	1020	2.9	18.1	304L2	—	BE132MB4	BX160MA4	ME4LB4	MX5SA4	10500	12000	21700	25700	5560	284
87	950	2.5	16.8	—	304R2	BE132MB4	BX160MA4	ME4LB4	MX5SA4	10200	11700	21200	25100	5420	286
92	900	2.0	15.9	—	303R2	BE132MB4	BX160MA4	ME4LB4	MX5SA4	10000	11500	20800	24700	5320	274
95	870	2.0	15.3	303L2	—	BE132MB4	BX160MA4	ME4LB4	MX5SA4	9910	11300	20600	24400	5260	272
98	840	1.5	14.8	301L2	—	BE132MB4	BX160MA4	ME4LB4	MX5SA4	3030	3030	10800	11800	1730	262
99	830	1.1	14.8	—	301R2	BE132MB4	BX160MA4	ME4LB4	MX5SA4	3030	3030	10800	11800	1730	264
107	770	2.6	13.7	—	303R2	BE132MB4	BX160MA4	ME4LB4	MX5SA4	9540	10900	19900	23600	5060	274
117	710	2.3	12.5	303L2	—	BE132MB4	BX160MA4	ME4LB4	MX5SA4	9260	10600	19400	23000	4910	272
121	680	1.0	12.1	300L2	—	BE132MB4	BX160MA4	ME4LB4	MX5SA4	2830	2830	10200	11800	1620	252
121	680	1.8	12.1	301L2	—	BE132MB4	BX160MA4	ME4LB4	MX5SA4	2830	2830	10200	11100	1620	262
123	670	1.7	11.8	—	301R2	BE132MB4	BX160MA4	ME4LB4	MX5SA4	2810	2810	10100	11100	1610	264

A

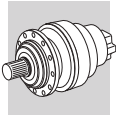

$P_1 = 9.2 \text{ kW}$

n_2 min ⁻¹	M_2 Nm	S	i	Motor		IE2		IE3		Rn_2 [N]					Icon
				303L1	301L1	BE132MB4	BX160MA4	ME4LB4	MX5SA4	MC	MZ	HC/PC	HZ/PZ	FZ	
151	560	1.4	9.67	303L1	—	BE132MB4	BX160MA4	ME4LB4	MX5SA4	8500	9710	17900	21300	4510	272
162	520	1.2	9.00	301L1	—	BE132MB4	BX160MA4	ME4LB4	MX5SA4	2570	2570	9320	10200	1470	262
167	490	1.3	8.74	—	300R2	BE132MB4	BX160MA4	ME4LB4	MX5SA4	2540	2540	9240	10700	1450	254
167	490	2.2	8.74	—	301R2	BE132MB4	BX160MA4	ME4LB4	MX5SA4	2540	2540	9240	10100	1450	264
195	440	2.8	7.50	303L1	—	BE132MB4	BX160MA4	ME4LB4	MX5SA4	7810	8920	16600	19700	4140	272
203	420	1.0	7.20	300L1	—	BE132MB4	BX160MA4	ME4LB4	MX5SA4	2380	2380	8720	10100	1360	252
203	420	1.8	7.20	301L1	—	BE132MB4	BX160MA4	ME4LB4	MX5SA4	2380	2380	8720	9530	1360	262
205	400	1.5	7.13	—	300R2	BE132MB4	BX160MA4	ME4LB4	MX5SA4	2380	2380	8690	10100	1360	254
205	400	2.6	7.13	—	301R2	BE132MB4	BX160MA4	ME4LB4	MX5SA4	2380	2380	8690	9500	1360	264
253	340	1.4	5.77	300L1	—	BE132MB4	BX160MA4	ME4LB4	MX5SA4	2210	2210	8160	9480	1260	252
253	340	2.8	5.77	301L1	—	BE132MB4	BX160MA4	ME4LB4	MX5SA4	2210	2210	8160	8910	1260	262
342	250	2.0	4.26	300L1	—	BE132MB4	BX160MA4	ME4LB4	MX5SA4	2000	2000	7450	8660	1140	252
420	200	2.3	3.48	300L1	—	BE132MB4	BX160MA4	ME4LB4	MX5SA4	1870	1870	7010	8150	1070	252

$P_1 = 11 \text{ kW}$

n_2 min ⁻¹	M_2 Nm	S	i	Motor		IE2		IE3		Rn_2 [N]					Icon
				317ML4	316ML4	BE160M4	BX160MB4	—	—	MC	MZ	HC/PC	HZ/PZ	FZ	
0.77	120600	1.2	1893	317ML4	—	BE160M4	BX160MB4	—	—	—	—	410300	435900	150000	414
0.92	101600	1.5	1595	317ML4	—	BE160M4	BX160MB4	—	—	—	—	400400	425300	150000	414
0.94	99000	1.2	1553	316ML4	—	BE160M4	BX160MB4	—	—	—	—	256300	287600	150000	404
1.1	81800	1.1	1284	315ML4	—	BE160M4	BX160MB4	—	—	—	—	163000	195500	86100	392
1.1	83400	1.4	1308	316ML4	—	BE160M4	BX160MB4	—	—	—	—	250100	280600	144500	404
1.1	84000	1.9	1318	317ML4	—	BE160M4	BX160MB4	—	—	—	—	389600	413900	144800	414
1.2	78900	1.5	1237	316ML4	—	BE160M4	BX160MB4	—	—	—	—	248200	278400	141800	404
1.3	70000	1.0	1099	314ML4	—	BE160M4	BX160MB4	—	—	—	—	159400	191200	81800	380
1.3	70400	1.3	1104	315ML4	—	BE160M4	BX160MB4	—	—	—	—	159500	191300	81900	392
1.3	70400	1.7	1104	316ML4	—	BE160M4	BX160MB4	—	—	—	—	244200	273900	136500	404
1.3	72300	2.2	1134	317ML4	—	BE160M4	BX160MB4	—	—	—	—	381300	405100	137700	414
1.4	66100	1.1	1038	314ML4	—	BE160M4	BX160MB4	—	—	—	—	158100	189600	80200	380
1.4	66500	1.5	1043	315ML4	—	BE160M4	BX160MB4	—	—	—	—	158200	189800	80400	392
1.4	65000	1.8	1020	316ML4	—	BE160M4	BX160MB4	—	—	—	—	241400	270800	132900	404
1.4	65800	2.7	1032	317ML4	—	BE160M4	BX160MB4	—	—	—	—	376300	399700	133500	414
1.5	60800	2.3	953	—	317MR4	BE160M4	BX160MB4	—	—	—	—	372000	395200	130000	416
1.6	56700	0.9	889	313ML4	—	BE160M4	BX160MB4	—	—	—	—	166400	195000	67700	368
1.6	59000	1.2	926	314ML4	—	BE160M4	BX160MB4	—	—	—	—	155600	186600	77200	380
1.6	59300	1.5	930	315ML4	—	BE160M4	BX160MB4	—	—	—	—	155700	186700	77400	392
1.6	58000	1.3	909	—	315MR4	BE160M4	BX160MB4	—	—	—	—	155200	186100	76800	394
1.6	57600	2.7	904	317ML4	—	BE160M4	BX160MB4	—	—	—	—	369200	392200	127700	414
1.7	54700	1.4	858	314ML4	—	BE160M4	BX160MB4	—	—	—	—	153900	184600	75300	380
1.7	54900	1.8	862	315ML4	—	BE160M4	BX160MB4	—	—	—	—	154000	184700	75400	392
1.7	56100	2.1	880	316ML4	—	BE160M4	BX160MB4	—	—	—	—	236400	265100	126600	404
1.9	50300	1.0	790	313ML4	—	BE160M4	BX160MB4	—	—	—	—	163600	191700	65100	368
1.9	49900	1.7	782	—	315MR4	BE160M4	BX160MB4	—	—	—	—	151900	182100	73000	394
1.9	50000	2.3	784	316ML4	—	BE160M4	BX160MB4	—	—	—	—	232500	260800	121800	404
1.9	49900	2.3	782	—	316MR4	BE160M4	BX160MB4	—	—	—	—	232400	260700	121700	406
2.0	47000	1.6	738	314ML4	—	BE160M4	BX160MB4	—	—	—	—	150600	180600	71600	380

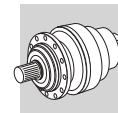

$P_1 = 11 \text{ kW}$

n ₂ min ⁻¹	M ₂ Nm	S	i	[Icon]		[Icon]		[Icon]		Rn ₂ [N]					[Icon]
				IE2	IE3	IE2	IE3	MC	MZ	HC/PC	HZ/PZ	FZ			
2.0	47300	2.0	741	315ML4	—	BE160M4	BX160MB4	—	—	—	—	150700	180800	71700	392
2.1	44300	1.1	695	313ML4	—	BE160M4	BX160MB4	—	—	—	—	160700	188300	62400	368
2.1	45000	2.5	706	316ML4	—	BE160M4	BX160MB4	—	—	—	—	229100	257000	117600	404
2.2	42600	1.8	668	314ML4	—	BE160M4	BX160MB4	—	—	—	—	148500	178100	69300	380
2.2	42800	2.2	672	315ML4	—	BE160M4	BX160MB4	—	—	—	—	148600	178200	69400	392
2.2	42000	2.0	659	—	315MR4	BE160M4	BX160MB4	—	—	—	—	148200	177700	69000	394
2.2	42000	2.7	659	—	316MR4	BE160M4	BX160MB4	—	—	—	—	226800	254400	114900	406
2.3	39900	1.0	627	311ML4	—	BE160M4	BX160MB4	—	—	—	—	109200	111500	49000	356
2.3	40100	1.0	629	—	311MR4	BE160M4	BX160MB4	—	—	—	—	109300	111500	49000	358
2.3	40300	1.2	633	313ML4	—	BE160M4	BX160MB4	—	—	—	—	158500	185800	60500	368
2.3	41200	1.2	647	—	313MR4	BE160M4	BX160MB4	—	—	—	—	159000	186300	60900	370
2.3	40000	2.8	628	316ML4	—	BE160M4	BX160MB4	—	—	—	—	225200	252700	113100	404
2.4	39100	1.4	614	—	314MR4	BE160M4	BX160MB4	—	—	—	—	146700	175900	67300	382
2.4	39700	2.4	623	—	315MR4	BE160M4	BX160MB4	—	—	—	—	147000	176300	67700	394
2.4	39700	2.9	623	—	316MR4	BE160M4	BX160MB4	—	—	—	—	225000	252400	112800	406
2.5	36600	1.8	575	314ML4	—	BE160M4	BX160MB4	—	—	—	—	145300	174300	65900	380
2.5	37500	1.9	588	314ML4	—	BE160M4	BX160MB4	—	—	—	—	145800	174900	66400	380
2.5	37700	2.5	591	315ML4	—	BE160M4	BX160MB4	—	—	—	—	145900	175000	66500	392
2.6	36200	1.1	568	311ML4	—	BE160M4	BX160MB4	—	—	—	—	107700	109900	47400	356
2.6	35900	1.5	564	313ML4	—	BE160M4	BX160MB4	—	—	—	—	155900	182700	58200	368
2.7	34100	1.4	535	—	313MR4	BE160M4	BX160MB4	—	—	—	—	154700	181300	57200	370
2.7	34000	2.8	533	315ML4	—	BE160M4	BX160MB4	—	—	—	—	143800	172400	64300	392
2.8	33100	1.2	520	—	311MR4	BE160M4	BX160MB4	—	—	—	—	106400	108500	46000	358
2.8	33700	2.0	528	—	314MR4	BE160M4	BX160MB4	—	—	—	—	143600	172200	64000	382
2.8	33500	2.8	525	—	315MR4	BE160M4	BX160MB4	—	—	—	—	143500	172100	63900	394
2.9	32600	1.4	512	311ML4	—	BE160M4	BX160MB4	—	—	—	—	106100	108300	45800	356
2.9	32700	1.5	514	313ML4	—	BE160M4	BX160MB4	—	—	—	—	153900	180300	56400	368
3.0	31200	1.0	490	—	311MR4	BE160M4	BX160MB4	—	—	—	—	105500	107600	45100	358
3.0	31600	1.5	496	—	313MR4	BE160M4	BX160MB4	—	—	—	—	153100	179400	55800	370
3.0	31500	2.4	495	314ML4	—	BE160M4	BX160MB4	—	—	—	—	142200	170600	62700	380
3.2	28900	1.0	453	310ML4	—	BE160M4	BX160MB4	—	—	—	—	83000	105300	44000	344
3.2	28800	2.0	452	313ML4	—	BE160M4	BX160MB4	—	—	—	—	151100	177000	54000	368
3.2	29200	2.6	458	314ML4	—	BE160M4	BX160MB4	—	—	—	—	140700	168700	61100	380
3.3	27900	1.4	438	—	311MR4	BE160M4	BX160MB4	—	—	—	—	103800	105900	43500	358
3.3	28700	1.6	450	—	313MR4	BE160M4	BX160MB4	—	—	—	—	151000	176900	54000	370
3.3	28400	2.1	445	—	314MR4	BE160M4	BX160MB4	—	—	—	—	140100	168000	60500	382
3.5	26300	1.5	413	—	311MR4	BE160M4	BX160MB4	—	—	—	—	102900	105000	42600	358
3.5	26800	2.6	421	—	314MR4	BE160M4	BX160MB4	—	—	—	—	139000	166700	59400	382
3.6	26200	1.8	410	311ML4	—	BE160M4	BX160MB4	—	—	—	—	102800	104900	42500	356
3.7	25100	2.2	394	313ML4	—	BE160M4	BX160MB4	—	—	—	—	148100	173600	51600	368
3.7	25100	3.0	394	314ML4	—	BE160M4	BX160MB4	—	—	—	—	137700	165100	58100	380
3.8	24400	1.0	383	—	310MR4	BE160M4	BX160MB4	—	—	—	—	81000	102700	41600	346
3.8	24700	1.8	387	—	313MR4	BE160M4	BX160MB4	—	—	—	—	147800	173200	51400	370
4.1	22600	2.6	354	—	314MR4	BE160M4	BX160MB4	—	—	—	—	135600	162700	56100	382
4.2	22200	1.0	349	309L4	—	BE160M4	BX160MB4	—	—	—	—	70700	91000	22300	334
4.2	22100	1.3	347	—	310MR4	BE160M4	BX160MB4	—	—	—	—	79900	101300	40200	346
4.2	22200	2.1	348	311ML4	—	BE160M4	BX160MB4	—	—	—	—	100400	102500	40200	356
4.2	22000	2.5	346	—	313MR4	BE160M4	BX160MB4	—	—	—	—	145400	170400	49400	370
4.3	21700	1.7	341	—	311MR4	BE160M4	BX160MB4	—	—	—	—	100200	102200	40000	358

A

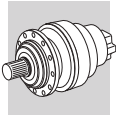

$P_1 = 11 \text{ kW}$

n ₂ min ⁻¹	M ₂ Nm	S	i	IE2		IE3		IE2		IE3		Rn ₂ [N]					
				MC	MZ	HC/PC	HZ/PZ	FZ									
4.7	19700	2.2	309	—	313MR4	BE160M4	BX160MB4	—	—	—	—	143100	167600	47600	370		
4.8	19400	1.2	305	—	310MR4	BE160M4	BX160MB4	—	—	—	—	78400	99500	38500	346		
4.8	20000	1.5	304	313ML3	—	BE160M4	BX160MB4	—	—	—	—	142700	167300	47300	368		
5.0	19400	1.2	295	310ML3	—	BE160M4	BX160MB4	—	—	—	—	78100	99000	38100	344		
5.0	19100	1.4	291	311ML3	—	BE160M4	BX160MB4	—	—	—	—	98000	100000	37900	356		
5.0	18700	2.0	294	—	311MR4	BE160M4	BX160MB4	—	—	—	—	98000	100000	38000	358		
5.1	18100	0.9	284	—	309R4	BE160M4	BX160MB4	—	—	—	—	69000	88800	20800	332		
5.2	17900	2.6	281	—	313MR4	BE160M4	BX160MB4	—	—	—	—	142000	166400	46100	370		
5.3	17600	1.6	276	—	310MR4	BE160M4	BX160MB4	—	—	—	—	78000	98900	37300	346		
5.3	17600	2.6	276	—	314MR4	BE160M4	BX160MB4	—	—	—	—	132000	158300	51600	382		
5.5	16900	2.6	266	—	311MR4	BE160M4	BX160MB4	—	—	—	—	98000	100000	36800	358		
5.7	16400	1.1	258	—	309R4	BE160M4	BX160MB4	—	—	—	—	69000	88800	20200	332		
5.7	16500	1.4	258	—	310MR4	BE160M4	BX160MB4	—	—	—	—	78000	98900	36400	346		
5.8	16600	2.6	252	313ML3	—	BE160M4	BX160MB4	—	—	—	—	142000	166400	44500	368		
5.9	16400	1.1	249	310ML3	—	BE160M4	BX160MB4	—	—	—	—	78000	98900	36000	344		
6.0	16100	2.2	245	311ML3	—	BE160M4	BX160MB4	—	—	—	—	98000	100000	35800	356		
6.2	15100	1.9	238	—	310MR4	BE160M4	BX160MB4	—	—	—	—	78000	98900	35400	346		
6.2	15100	2.6	237	—	313MR4	BE160M4	BX160MB4	—	—	—	—	142000	166400	43600	370		
6.2	15100	2.6	238	—	314MR4	BE160M4	BX160MB4	—	—	—	—	132000	158300	49100	382		
6.3	14800	1.1	232	—	309R4	BE160M4	BX160MB4	—	—	—	—	69000	88800	19500	332		
6.4	15100	1.3	230	310ML3	—	BE160M4	BX160MB4	—	—	—	—	78000	98900	35100	344		
6.4	14600	2.6	229	—	311MR4	BE160M4	BX160MB4	—	—	—	—	98000	100000	35000	358		
7.1	13100	1.1	206	—	307R4	BE160M4	BX160MB4	—	—	30000	37500	67500	88800	23400	322		
7.1	13100	1.5	206	—	309R4	BE160M4	BX160MB4	—	—	—	—	69000	88800	18700	332		
7.1	13100	1.7	206	—	310MR4	BE160M4	BX160MB4	—	—	—	—	78000	98900	33800	346		
7.2	13300	2.7	203	311ML3	—	BE160M4	BX160MB4	—	—	—	—	98000	100000	33600	356		
7.3	13200	1.2	202	309L3	—	BE160M4	BX160MB4	—	—	—	—	69000	88800	18600	334		
7.3	13300	1.7	202	310ML3	—	BE160M4	BX160MB4	—	—	—	—	78000	98900	33600	344		
7.3	12800	2.6	201	—	313MR4	BE160M4	BX160MB4	—	—	—	—	142000	166400	41200	370		
7.4	12600	2.6	198	—	311MR4	BE160M4	BX160MB4	—	—	—	—	98000	100000	33400	358		
7.7	12200	1.2	191	—	307R4	BE160M4	BX160MB4	—	—	30000	37500	67500	88800	22800	322		
7.7	12200	1.4	191	—	309R4	BE160M4	BX160MB4	—	—	—	—	69000	88800	18200	332		
7.7	12100	2.3	189	—	310MR4	BE160M4	BX160MB4	—	—	—	—	78000	98900	32900	346		
7.7	12600	2.5	191	311ML3	—	BE160M4	BX160MB4	—	—	—	—	98000	100000	33000	356		
7.7	12100	2.6	189	—	314MR4	BE160M4	BX160MB4	—	—	—	—	132000	158300	45500	382		
7.9	11800	2.6	185	—	313MR4	BE160M4	BX160MB4	—	—	—	—	142000	166400	40100	370		
8.0	12000	1.2	183	309L3	—	BE160M4	BX160MB4	—	—	—	—	69000	88800	18000	334		
8.0	11600	2.6	182	—	311MR4	BE160M4	BX160MB4	—	—	—	—	98000	100000	32400	358		
8.0	12000	2.5	182	313ML3	—	BE160M4	BX160MB4	—	—	—	—	142000	166400	39900	368		
8.3	11600	1.1	177	307L3	—	BE160M4	BX160MB4	—	—	30000	37500	67500	88800	22200	320		
8.3	11600	1.5	177	310ML3	—	BE160M4	BX160MB4	—	—	—	—	78000	98900	32100	344		
8.9	10500	1.0	165	—	307R4	BE160M4	BX160MB4	—	—	30000	37500	67500	88800	21700	322		
8.9	10500	1.5	165	—	309R4	BE160M4	BX160MB4	—	—	—	—	69000	88800	17400	332		
9.0	10800	2.5	164	310ML3	—	BE160M4	BX160MB4	—	—	—	—	78000	98900	31300	344		
9.1	10600	1.0	162	307L3	—	BE160M4	BX160MB4	—	—	30000	37500	67500	88800	21600	320		
9.1	10600	1.5	162	309L3	—	BE160M4	BX160MB4	—	—	—	—	69000	88800	17300	334		
9.1	10200	2.6	160	—	310MR4	BE160M4	BX160MB4	—	—	—	—	78000	98900	31100	346		
9.1	10200	2.6	160	—	314MR4	BE160M4	BX160MB4	—	—	—	—	132000	158300	43100	382		
9.3	10100	1.0	158	—	306R4	BE160M4	BX160MB4	—	—	25000	28500	57000	65800	16700	310		

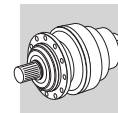

$P_1 = 11 \text{ kW}$

n ₂ min ⁻¹	M ₂ Nm	S	i	IE2		IE3		IE2		IE3		Rn ₂ [N]					📄
				MC	MZ	HC/PC	HZ/PZ	FZ									
9.5	9840	2.6	154	—	311MR4	BE160M4	BX160MB4	—	—	—	—	98000	100000	30700	358		
9.6	9690	1.4	152	—	307R4	BE160M4	BX160MB4	—	—	30000	37500	67500	88800	21100	322		
9.6	9690	1.9	152	—	309R4	BE160M4	BX160MB4	—	—	—	—	69000	88800	16900	332		
9.8	9810	2.2	149	310ML3	—	BE160M4	BX160MB4	—	—	—	—	78000	98900	30400	344		
10.0	9620	1.4	146	307L3	—	BE160M4	BX160MB4	—	—	30000	37500	67500	88800	20900	320		
10.0	9640	2.8	147	—	311MR3	BE160M4	BX160MB4	—	—	—	—	98000	100000	30200	358		
10.6	9120	1.2	139	307L3	—	BE160M4	BX160MB4	—	—	29500	36800	66400	87400	20500	320		
10.6	9120	1.8	139	309L3	—	BE160M4	BX160MB4	—	—	—	—	67900	87400	16400	334		
10.8	8890	2.9	135	310ML3	—	BE160M4	BX160MB4	—	—	—	—	76200	96600	29400	344		
10.8	8660	2.6	136	—	310MR4	BE160M4	BX160MB4	—	—	—	—	76300	96700	29400	346		
11.6	8270	1.6	126	307L3	—	BE160M4	BX160MB4	—	—	28500	35700	64500	84800	19900	320		
11.6	8270	2.0	126	309L3	—	BE160M4	BX160MB4	—	—	—	—	65900	84800	15900	334		
12.1	7970	1.0	121	306L3	—	BE160M4	BX160MB4	—	—	23500	26800	53900	62200	15300	308		
12.2	7870	1.1	120	—	307R3	BE160M4	BX160MB4	—	—	28000	35100	63500	83600	19500	322		
12.2	7870	1.6	120	—	309R3	BE160M4	BX160MB4	—	—	—	—	64900	83600	15600	332		
12.2	7870	2.2	120	—	310MR3	BE160M4	BX160MB4	—	—	—	—	73400	93100	28200	346		
12.3	7820	2.8	119	310ML3	—	BE160M4	BX160MB4	—	—	—	—	73300	92900	28200	344		
12.9	7440	1.4	113	307L3	—	BE160M4	BX160MB4	—	—	27500	34400	62500	82200	19200	320		
12.9	7440	2.1	113	309L3	—	BE160M4	BX160MB4	—	—	—	—	63900	82200	15300	334		
13.0	7380	1.0	112	306L3	—	BE160M4	BX160MB4	—	—	22900	26100	52600	60800	14900	308		
14.1	6850	1.3	104	306L3	—	BE160M4	BX160MB4	—	—	22300	25400	51500	59400	14500	308		
14.6	6590	1.9	100	307L3	—	BE160M4	BX160MB4	—	—	26400	33100	60200	79300	18400	320		
14.6	6590	2.5	100	309L3	—	BE160M4	BX160MB4	—	—	—	—	61600	79300	14700	334		
14.8	6500	1.3	99.0	—	307R3	BE160M4	BX160MB4	—	—	26300	32900	60000	78900	18300	322		
14.8	6500	2.0	99.0	—	309R3	BE160M4	BX160MB4	—	—	—	—	61300	78900	14700	332		
14.8	6500	2.5	99.0	—	310MR3	BE160M4	BX160MB4	—	—	—	—	69300	87900	26500	346		
14.9	6470	1.0	98.5	—	306R3	BE160M4	BX160MB4	—	—	21900	25000	50600	58400	14200	310		
15.8	6110	2.0	93.0	307L3	—	BE160M4	BX160MB4	—	—	25800	32200	58900	77500	18000	320		
15.8	6110	2.5	93.0	309L3	—	BE160M4	BX160MB4	—	—	—	—	60200	77500	14400	334		
16.6	5800	1.5	88.3	306L3	—	BE160M4	BX160MB4	—	—	21100	24100	49000	56500	13700	308		
17.3	5570	1.4	84.7	—	306R3	BE160M4	BX160MB4	—	—	20800	23700	48400	55800	13500	310		
17.6	5480	1.9	83.4	—	307R3	BE160M4	BX160MB4	—	—	24900	31100	57000	75000	17300	322		
17.6	5480	2.6	83.4	—	309R3	BE160M4	BX160MB4	—	—	—	—	58300	75000	13800	332		
17.6	5480	2.6	83.4	—	310MR3	BE160M4	BX160MB4	—	—	—	—	65900	83500	25000	346		
17.9	5380	1.3	81.9	306L3	—	BE160M4	BX160MB4	—	—	20600	23500	47900	55300	13400	308		
18.2	5290	1.9	80.6	307L3	—	BE160M4	BX160MB4	—	—	24600	30700	56400	74200	17100	320		
18.2	5290	2.8	80.6	309L3	—	BE160M4	BX160MB4	—	—	—	—	57700	74200	13700	334		
18.6	5170	2.2	78.6	—	307R3	BE160M4	BX160MB4	—	—	24400	30500	56000	73700	17000	322		
18.6	5170	2.6	78.6	—	310MR3	BE160M4	BX160MB4	—	—	—	—	64700	82100	24500	346		
19.0	5080	1.0	77.2	305L3	—	BE160M4	BX160MB4	—	—	17000	19400	33400	39600	9000	296		
19.0	5060	1.7	77.0	306L3	—	BE160M4	BX160MB4	—	—	20200	23000	47000	54300	13100	308		
19.8	4870	2.4	74.1	307L3	—	BE160M4	BX160MB4	—	—	23900	29900	55000	72400	16600	320		
20.1	4790	1.6	72.9	—	306R3	BE160M4	BX160MB4	—	—	19800	22600	46200	53400	12900	310		
20.2	4910	1.1	72.5	306L2	—	BE160M4	BX160MB4	ME5SA4	MX5SB4	19800	22500	46200	53300	12800	308		
20.4	4710	2.1	71.8	—	307R3	BE160M4	BX160MB4	—	—	23600	29600	54500	71700	16500	322		
20.4	4710	2.7	71.8	—	309R3	BE160M4	BX160MB4	—	—	—	—	55700	71700	13200	332		
20.4	4710	2.6	71.8	—	310MR3	BE160M4	BX160MB4	—	—	—	—	63000	79800	23800	346		
21.7	4440	1.6	67.5	—	306R3	BE160M4	BX160MB4	—	—	19300	22000	45200	52200	12500	310		
22.5	4290	1.8	65.2	306L3	—	BE160M4	BX160MB4	—	—	19100	21800	44700	51600	12400	308		

A

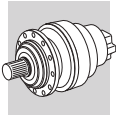

$P_1 = 11 \text{ kW}$

n_2 min ⁻¹	M_2 Nm	S	i	[Icons]		IE2		IE3		R _{n2} [N]					[Icon]
				[Icon]	[Icon]	[Icon]	[Icon]	IE2	[Icon]	IE3	MC	MZ	HC/PC	HZ/PZ	
22.5	4270	2.6	65.0	—	307R3	BE160M4	BX160MB4	—	—	22900	28600	52900	69600	15900	322
22.5	4270	2.6	65.0	—	309R3	BE160M4	BX160MB4	—	—	—	—	54100	69600	12700	332
22.5	4270	2.6	65.0	—	310MR3	BE160M4	BX160MB4	—	—	—	—	61100	77500	23000	346
23.2	4140	1.1	63.1	305L3	—	BE160M4	BX160MB4	—	—	15900	18100	31400	37300	8410	296
24.2	3980	2.8	60.5	307L3	—	BE160M4	BX160MB4	—	—	22300	27900	51800	68100	15600	320
25.2	3820	2.0	58.1	—	306R3	BE160M4	BX160MB4	—	—	18400	20900	43200	49900	11900	310
26.0	3810	1.4	56.3	306L2	—	BE160M4	BX160MB4	ME5SA4	MX5SB4	18200	20700	42800	49400	11800	308
26.2	3670	2.7	55.9	—	307R3	BE160M4	BX160MB4	—	—	21800	27200	50600	66500	15200	322
26.2	3670	2.7	55.9	—	309R3	BE160M4	BX160MB4	—	—	—	—	51700	66500	12100	332
26.2	3670	2.6	55.9	—	310MR3	BE160M4	BX160MB4	—	—	—	—	58400	74100	21900	346
26.3	3780	0.9	55.8	305L2	—	BE160M4	BX160MB4	—	—	15200	17400	30300	35900	8080	296
27.4	3510	0.9	53.4	304L3	—	BE160M4	BX160MB4	—	—	15000	17100	29900	35500	7960	284
27.4	3510	1.1	53.4	305L3	—	BE160M4	BX160MB4	—	—	15000	17100	29900	35500	7960	296
27.5	3500	2.0	53.2	306L3	—	BE160M4	BX160MB4	—	—	17800	20300	42100	48600	11600	308
31	3170	2.6	46.7	307L2	—	BE160M4	BX160MB4	ME5SA4	MX5SB4	20500	25600	47900	63000	14300	320
32	3150	2.1	46.5	306L2	—	BE160M4	BX160MB4	ME5SA4	MX5SB4	17100	19400	40400	46600	11100	308
32	3040	2.5	46.3	—	306R3	BE160M4	BX160MB4	—	—	17000	19400	40300	46600	11100	310
33	3020	1.2	44.6	305L2	—	BE160M4	BX160MB4	—	—	14100	16200	28400	33600	7500	296
33	2930	2.7	44.6	—	307R3	BE160M4	BX160MB4	—	—	20200	25200	47200	62100	14000	322
33	2930	2.7	44.6	—	309R3	BE160M4	BX160MB4	—	—	—	—	48300	62100	11200	332
33	2930	2.6	44.6	—	310MR3	BE160M4	BX160MB4	—	—	—	—	54600	69200	20300	346
34	2860	1.1	43.6	304L3	—	BE160M4	BX160MB4	—	—	14000	16000	28200	33400	7440	284
37	2580	2.6	39.2	—	306R3	BE160M4	BX160MB4	—	—	16100	18400	38400	44300	10500	310
38	2600	1.1	38.4	304L2	—	BE160M4	BX160MB4	—	—	13400	15400	27100	32100	7130	284
38	2600	1.7	38.4	305L2	—	BE160M4	BX160MB4	—	—	13400	15400	27100	32100	7130	296
38	2600	2.5	38.4	306L2	—	BE160M4	BX160MB4	ME5SA4	MX5SB4	16000	18200	38200	44000	10400	308
39	2480	2.7	37.7	—	307R3	BE160M4	BX160MB4	—	—	19100	23900	44900	59100	13300	322
39	2480	2.7	37.7	—	309R3	BE160M4	BX160MB4	—	—	—	—	45900	59100	10600	332
39	2480	2.6	37.7	—	310MR3	BE160M4	BX160MB4	—	—	—	—	51900	65800	19200	346
41	2420	1.5	35.8	305L2	—	BE160M4	BX160MB4	—	—	13100	15000	26500	31400	6960	296
44	2180	2.7	33.2	—	306R3	BE160M4	BX160MB4	—	—	15200	17400	36500	42200	9910	310
46	2080	2.7	31.6	—	307R3	BE160M4	BX160MB4	—	—	18000	22500	42600	56100	12500	322
46	2080	2.7	31.6	—	309R3	BE160M4	BX160MB4	—	—	—	—	43600	56100	10000	332
48	2080	1.0	30.8	303L2	—	BE160M4	BX160MB4	—	—	12500	14300	25400	30100	6620	272
48	2080	1.4	30.8	304L2	—	BE160M4	BX160MB4	—	—	12500	14300	25400	30100	6620	284
48	2080	2.1	30.8	305L2	—	BE160M4	BX160MB4	—	—	12500	14300	25400	30100	6620	296
55	1790	1.0	26.4	303L2	—	BE160M4	BX160MB4	—	—	11900	13600	24200	28700	6290	272
55	1790	2.0	26.4	305L2	—	BE160M4	BX160MB4	—	—	11900	13600	24200	28700	6290	296
60	1660	1.3	24.5	303L2	—	BE160M4	BX160MB4	—	—	11600	13200	23700	28100	6140	272
60	1660	2.0	24.5	304L2	—	BE160M4	BX160MB4	—	—	11600	13200	23700	28100	6140	284
60	1660	2.3	24.5	305L2	—	BE160M4	BX160MB4	—	—	11600	13200	23700	28100	6140	296
64	1540	1.4	22.7	303L2	—	BE160M4	BX160MB4	—	—	11300	12900	23200	27400	5990	272
64	1540	1.8	22.7	304L2	—	BE160M4	BX160MB4	—	—	11300	12900	23200	27400	5990	284
64	1540	2.6	22.7	305L2	—	BE160M4	BX160MB4	—	—	11300	12900	23200	27400	5990	296
71	1410	1.3	20.8	303L2	—	BE160M4	BX160MB4	—	—	10900	12500	22500	26700	5810	272
71	1410	2.1	20.8	304L2	—	BE160M4	BX160MB4	—	—	10900	12500	22500	26700	5810	284
71	1410	2.3	20.8	305L2	—	BE160M4	BX160MB4	—	—	10900	12500	22500	26700	5810	296
76	1300	2.7	19.2	—	306R2	BE160M4	BX160MB4	—	—	12700	14500	31000	35800	8250	310
81	1230	1.7	18.1	303L2	—	BE160M4	BX160MB4	—	—	10500	12000	21600	25600	5550	272

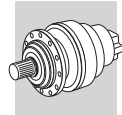

$P_1 = 11 \text{ kW}$

n_2 min ⁻¹	M_2 Nm	S	i	IE2		IE3		Rn ₂ [N]					📄		
				IE2	IE3	IE2	IE3	MC	MZ	HC/PC	HZ/PZ	FZ			
81	1230	2.4	18.1	304L2	—	BE160M4	BX160MB4	—	—	10500	12000	21600	25600	5550	284
81	1230	3.0	18.1	305L2	—	BE160M4	BX160MB4	—	—	10500	12000	21600	25600	5550	296
92	1080	2.7	15.9	—	306R2	BE160M4	BX160MB4	—	—	11900	13600	29300	33800	7750	310
95	1040	1.7	15.3	303L2	—	BE160M4	BX160MB4	—	—	9900	11300	20600	24400	5250	272
95	1040	2.7	15.3	304L2	—	BE160M4	BX160MB4	—	—	9900	11300	20600	24400	5250	284
95	1040	3.0	15.3	305L2	—	BE160M4	BX160MB4	—	—	9900	11300	20600	24400	5250	296
107	930	2.7	13.7	—	306R2	BE160M4	BX160MB4	—	—	11300	12900	28000	32300	7370	310
117	850	1.9	12.5	303L2	—	BE160M4	BX160MB4	—	—	9250	10600	19400	23000	4910	272
135	740	2.7	10.9	—	306R2	BE160M4	BX160MB4	—	—	10500	12000	26100	30200	6830	310
152	680	1.1	9.67	303L1	—	BE160M4	BX160MB4	ME5SA4	MX5SB4	8490	9700	17900	21200	4500	272
159	620	2.7	9.23	—	306R2	BE160M4	BX160MB4	—	—	9950	11300	24900	28700	6460	310
195	520	2.3	7.50	303L1	—	BE160M4	BX160MB4	ME5SA4	MX5SB4	7800	8910	16600	19700	4140	272

$P_1 = 15 \text{ kW}$

n_2 min ⁻¹	M_2 Nm	S	i	IE2		IE3		Rn ₂ [N]					📄		
				IE2	IE3	IE2	IE3	MC	MZ	HC/PC	HZ/PZ	FZ			
0.77	164200	0.9	1893	317ML4	—	BE160L4	BX160L4	—	—	—	—	410300	435900	150000	414
0.92	138400	1.1	1595	317ML4	—	BE160L4	BX160L4	—	—	—	—	400400	425300	150000	414
0.94	134700	0.9	1553	316ML4	—	BE160L4	BX160L4	—	—	—	—	256300	287600	150000	404
1.1	113500	1.1	1308	316ML4	—	BE160L4	BX160L4	—	—	—	—	250100	280600	144500	404
1.1	114400	1.4	1318	317ML4	—	BE160L4	BX160L4	—	—	—	—	389600	413900	144800	414
1.2	107400	1.1	1237	316ML4	—	BE160L4	BX160L4	—	—	—	—	248200	278400	141800	404
1.3	95800	0.9	1104	315ML4	—	BE160L4	BX160L4	—	—	—	—	159500	191300	81900	392
1.3	95800	1.2	1104	316ML4	—	BE160L4	BX160L4	—	—	—	—	244200	273900	136500	404
1.3	98400	1.6	1134	317ML4	—	BE160L4	BX160L4	—	—	—	—	381300	405100	137700	414
1.4	90500	1.1	1043	315ML4	—	BE160L4	BX160L4	—	—	—	—	158200	189800	80400	392
1.4	88500	1.3	1020	316ML4	—	BE160L4	BX160L4	—	—	—	—	241400	270800	132900	404
1.4	89600	2.0	1032	317ML4	—	BE160L4	BX160L4	—	—	—	—	376300	399700	133500	414
1.5	82700	1.7	953	—	317MR4	BE160L4	BX160L4	—	—	—	—	372000	395200	130000	416
1.6	80700	1.1	930	315ML4	—	BE160L4	BX160L4	—	—	—	—	155700	186700	77400	392
1.6	78900	0.9	909	—	315MR4	BE160L4	BX160L4	—	—	—	—	155200	186100	76800	394
1.6	78400	2.0	904	317ML4	—	BE160L4	BX160L4	—	—	—	—	369200	392200	127700	414
1.7	74400	1.0	858	314ML4	—	BE160L4	BX160L4	—	—	—	—	153900	184600	75300	380
1.7	74800	1.3	862	315ML4	—	BE160L4	BX160L4	—	—	—	—	154000	184700	75400	392
1.7	76300	1.5	880	316ML4	—	BE160L4	BX160L4	—	—	—	—	236400	265100	126600	404
1.8	68700	2.8	792	317ML4	—	BE160L4	BX160L4	—	—	—	—	362300	384900	122200	414
1.8	69700	2.2	803	—	317MR4	BE160L4	BX160L4	—	—	—	—	363000	385600	122800	416
1.9	67900	1.3	782	—	315MR4	BE160L4	BX160L4	—	—	—	—	151900	182100	73000	394
1.9	68000	1.7	784	316ML4	—	BE160L4	BX160L4	—	—	—	—	232500	260800	121800	404
1.9	67900	1.7	782	—	316MR4	BE160L4	BX160L4	—	—	—	—	232400	260700	121700	406
2.0	64000	1.2	738	314ML4	—	BE160L4	BX160L4	—	—	—	—	150600	180600	71600	380
2.0	64300	1.5	741	315ML4	—	BE160L4	BX160L4	—	—	—	—	150700	180800	71700	392
2.0	62400	2.7	719	317ML4	—	BE160L4	BX160L4	—	—	—	—	357300	379600	118300	414
2.1	61300	1.9	706	316ML4	—	BE160L4	BX160L4	—	—	—	—	229100	257000	117600	404
2.2	58000	1.3	668	314ML4	—	BE160L4	BX160L4	—	—	—	—	148500	178100	69300	380
2.2	58300	1.6	672	315ML4	—	BE160L4	BX160L4	—	—	—	—	148600	178200	69400	392
2.2	57200	1.5	659	—	315MR4	BE160L4	BX160L4	—	—	—	—	148200	177700	69000	394



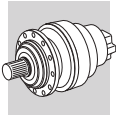

$P_1 = 15 \text{ kW}$

n_2 min ⁻¹	M_2 Nm	S	i	IE2		IE3		IE2		IE3		R _{n2} [N]					
				MC	MZ	HC/PC	HZ/PZ	FZ									
2.2	57200	2.0	659	—	316MR4	BE160L4	BX160L4	—	—	—	—	226800	254400	114900	406		
2.2	58700	2.7	677	—	317MR4	BE160L4	BX160L4	—	—	—	—	354200	376300	116000	416		
2.3	54500	2.1	628	316ML4	—	BE160L4	BX160L4	—	—	—	—	225200	252700	113100	404		
2.3	54300	2.2	626	—	317MR4	BE160L4	BX160L4	—	—	—	—	350300	372100	113000	416		
2.4	53200	1.0	614	—	314MR4	BE160L4	BX160L4	—	—	—	—	146700	175900	67300	382		
2.4	54100	1.8	623	—	315MR4	BE160L4	BX160L4	—	—	—	—	147000	176300	67700	394		
2.4	54100	2.1	623	—	316MR4	BE160L4	BX160L4	—	—	—	—	225000	252400	112800	406		
2.5	49900	1.4	575	314ML4	—	BE160L4	BX160L4	—	—	—	—	145300	174300	65900	380		
2.5	51000	1.4	588	314ML4	—	BE160L4	BX160L4	—	—	—	—	145800	174900	66400	380		
2.5	51300	1.8	591	315ML4	—	BE160L4	BX160L4	—	—	—	—	145900	175000	66500	392		
2.6	48900	1.1	564	313ML4	—	BE160L4	BX160L4	—	—	—	—	155900	182700	58200	368		
2.6	48800	2.3	563	316ML4	—	BE160L4	BX160L4	—	—	—	—	221700	248800	109000	404		
2.7	46400	1.0	535	—	313MR4	BE160L4	BX160L4	—	—	—	—	154700	181300	57200	370		
2.7	46300	2.0	533	315ML4	—	BE160L4	BX160L4	—	—	—	—	143800	172400	64300	392		
2.8	45800	1.4	528	—	314MR4	BE160L4	BX160L4	—	—	—	—	143600	172200	64000	382		
2.8	45600	2.1	525	—	315MR4	BE160L4	BX160L4	—	—	—	—	143500	172100	63900	394		
2.8	45600	2.8	525	—	316MR4	BE160L4	BX160L4	—	—	—	—	219600	246300	106600	406		
2.9	44400	1.0	512	311ML4	—	BE160L4	BX160L4	—	—	—	—	106100	108300	45800	356		
2.9	44600	1.1	514	313ML4	—	BE160L4	BX160L4	—	—	—	—	153900	180300	56400	368		
2.9	43400	2.9	500	316ML4	—	BE160L4	BX160L4	—	—	—	—	218100	244600	104900	404		
3.0	43000	1.1	496	—	313MR4	BE160L4	BX160L4	—	—	—	—	153100	179400	55800	370		
3.0	42900	1.8	495	314ML4	—	BE160L4	BX160L4	—	—	—	—	142200	170600	62700	380		
3.0	42200	2.2	487	315ML4	—	BE160L4	BX160L4	—	—	—	—	141900	170200	62300	392		
3.2	39200	1.5	452	313ML4	—	BE160L4	BX160L4	—	—	—	—	151100	177000	54000	368		
3.2	39700	1.9	458	314ML4	—	BE160L4	BX160L4	—	—	—	—	140700	168700	61100	380		
3.3	38000	1.0	438	—	311MR4	BE160L4	BX160L4	—	—	—	—	103800	105900	43500	358		
3.3	39100	1.2	450	—	313MR4	BE160L4	BX160L4	—	—	—	—	151000	176900	54000	370		
3.3	38600	1.5	445	—	314MR4	BE160L4	BX160L4	—	—	—	—	140100	168000	60500	382		
3.3	38300	2.5	441	315ML4	—	BE160L4	BX160L4	—	—	—	—	139900	167800	60300	392		
3.4	37300	2.8	430	—	316MR4	BE160L4	BX160L4	—	—	—	—	213400	239400	99700	406		
3.5	35800	1.1	413	—	311MR4	BE160L4	BX160L4	—	—	—	—	102900	105000	42600	358		
3.5	36500	1.9	421	—	314MR4	BE160L4	BX160L4	—	—	—	—	139000	166700	59400	382		
3.6	35600	1.3	410	311ML4	—	BE160L4	BX160L4	—	—	—	—	102800	104900	42500	356		
3.6	35500	2.7	409	—	315MR4	BE160L4	BX160L4	—	—	—	—	138500	166000	58800	394		
3.7	34200	1.7	394	313ML4	—	BE160L4	BX160L4	—	—	—	—	148100	173600	51600	368		
3.7	34200	2.2	394	314ML4	—	BE160L4	BX160L4	—	—	—	—	137700	165100	58100	380		
3.8	33600	1.3	387	—	313MR4	BE160L4	BX160L4	—	—	—	—	147800	173200	51400	370		
4.0	32100	3.0	370	315ML4	—	BE160L4	BX160L4	—	—	—	—	136500	163600	56900	392		
4.1	30800	1.9	354	—	314MR4	BE160L4	BX160L4	—	—	—	—	135600	162700	56100	382		
4.2	30100	1.0	347	—	310MR4	BE160L4	BX160L4	—	—	—	—	79900	101300	40200	346		
4.2	30200	1.5	348	311ML4	—	BE160L4	BX160L4	—	—	—	—	100400	102500	40200	356		
4.2	30000	1.9	346	—	313MR4	BE160L4	BX160L4	—	—	—	—	145400	170400	49400	370		
4.3	29600	1.3	341	—	311MR4	BE160L4	BX160L4	—	—	—	—	100200	102200	40000	358		
4.7	26800	1.6	309	—	313MR4	BE160L4	BX160L4	—	—	—	—	143100	167600	47600	370		
4.7	27200	2.8	314	314ML4	—	BE160L4	BX160L4	—	—	—	—	133300	159900	53900	380		
4.8	27200	1.1	304	313ML3	—	BE160L4	BX160L4	—	—	—	—	142700	167300	47300	368		
5.0	26000	1.1	291	311ML3	—	BE160L4	BX160L4	—	—	—	—	98000	100000	37900	356		
5.0	25500	1.4	294	—	311MR4	BE160L4	BX160L4	—	—	—	—	98000	100000	38000	358		
5.2	24400	1.9	281	—	313MR4	BE160L4	BX160L4	—	—	—	—	142000	166400	46100	370		

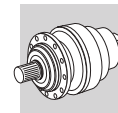

$P_1 = 15 \text{ kW}$

n ₂ min ⁻¹	M ₂ Nm	S	i	IE2		IE3		IE2		IE3		Rn ₂ [N]					📄
				MC	MZ	HC/PC	HZ/PZ	FZ									
5.3	24000	1.2	276	—	310MR4	BE160L4	BX160L4	—	—	—	—	78000	98900	37300	346		
5.3	24000	1.9	276	—	314MR4	BE160L4	BX160L4	—	—	—	—	132000	158300	51600	382		
5.5	23100	1.9	266	—	311MR4	BE160L4	BX160L4	—	—	—	—	98000	100000	36800	358		
5.7	22400	1.0	258	—	310MR4	BE160L4	BX160L4	—	—	—	—	78000	98900	36400	346		
5.8	22600	1.9	252	313ML3	—	BE160L4	BX160L4	—	—	—	—	142000	166400	44500	368		
6.0	21900	1.7	245	311ML3	—	BE160L4	BX160L4	—	—	—	—	98000	100000	35800	356		
6.1	21400	2.2	240	314ML3	—	BE160L4	BX160L4	—	—	—	—	132000	158300	49200	380		
6.2	20600	1.4	238	—	310MR4	BE160L4	BX160L4	—	—	—	—	78000	98900	35400	346		
6.2	20600	1.9	237	—	313MR4	BE160L4	BX160L4	—	—	—	—	142000	166400	43600	370		
6.2	20600	1.9	238	—	314MR4	BE160L4	BX160L4	—	—	—	—	132000	158300	49100	382		
6.4	20600	0.9	230	310ML3	—	BE160L4	BX160L4	—	—	—	—	78000	98900	35100	344		
6.4	19800	1.9	229	—	311MR4	BE160L4	BX160L4	—	—	—	—	98000	100000	35000	358		
7.0	18700	2.3	209	313ML3	—	BE160L4	BX160L4	—	—	—	—	142000	166400	41800	368		
7.1	17800	1.1	206	—	309R4	BE160L4	BX160L4	—	—	—	—	69000	88800	18700	332		
7.1	17900	1.2	206	—	310MR4	BE160L4	BX160L4	—	—	—	—	78000	98900	33800	346		
7.2	18100	2.0	203	311ML3	—	BE160L4	BX160L4	—	—	—	—	98000	100000	33600	356		
7.3	18000	0.9	202	309L3	—	BE160L4	BX160L4	—	—	—	—	69000	88800	18600	334		
7.3	18100	1.2	202	310ML3	—	BE160L4	BX160L4	—	—	—	—	78000	98900	33600	344		
7.3	17400	1.9	201	—	313MR4	BE160L4	BX160L4	—	—	—	—	142000	166400	41200	370		
7.4	17200	1.9	198	—	311MR4	BE160L4	BX160L4	—	—	—	—	98000	100000	33400	358		
7.6	17300	2.8	194	313ML3	—	BE160L4	BX160L4	—	—	—	—	142000	166400	40700	368		
7.7	16500	1.0	191	—	309R4	BE160L4	BX160L4	—	—	—	—	69000	88800	18200	332		
7.7	16400	1.7	189	—	310MR4	BE160L4	BX160L4	—	—	—	—	78000	98900	32900	346		
7.7	17100	1.9	191	311ML3	—	BE160L4	BX160L4	—	—	—	—	98000	100000	33000	356		
7.7	16400	1.9	189	—	314MR4	BE160L4	BX160L4	—	—	—	—	132000	158300	45500	382		
7.9	16000	1.9	185	—	313MR4	BE160L4	BX160L4	—	—	—	—	142000	166400	40100	370		
8.0	15800	1.9	182	—	311MR4	BE160L4	BX160L4	—	—	—	—	98000	100000	32400	358		
8.0	16300	1.9	182	313ML3	—	BE160L4	BX160L4	—	—	—	—	142000	166400	39900	368		
8.3	15900	1.1	177	310ML3	—	BE160L4	BX160L4	—	—	—	—	78000	98900	32100	344		
8.3	15700	2.7	176	313ML3	—	BE160L4	BX160L4	—	—	—	—	142000	166400	39500	368		
8.6	15300	2.3	171	311ML3	—	BE160L4	BX160L4	—	—	—	—	98000	100000	31800	356		
8.9	14300	1.1	165	—	309R4	BE160L4	BX160L4	—	—	—	—	69000	88800	17400	332		
9.0	14600	1.8	164	310ML3	—	BE160L4	BX160L4	—	—	—	—	78000	98900	31300	344		
9.1	14400	1.1	162	309L3	—	BE160L4	BX160L4	—	—	—	—	69000	88800	17300	334		
9.1	13900	1.9	160	—	310MR4	BE160L4	BX160L4	—	—	—	—	78000	98900	31100	346		
9.1	14400	2.4	161	311ML3	—	BE160L4	BX160L4	—	—	—	—	98000	100000	31100	356		
9.1	13900	1.9	160	—	314MR4	BE160L4	BX160L4	—	—	—	—	132000	158300	43100	382		
9.5	13400	1.9	154	—	311MR4	BE160L4	BX160L4	—	—	—	—	98000	100000	30700	358		
9.6	13200	1.0	152	—	307R4	BE160L4	BX160L4	—	—	30000	37500	67500	88800	21100	322		
9.6	13200	1.4	152	—	309R4	BE160L4	BX160L4	—	—	—	—	69000	88800	16900	332		
9.6	13700	2.2	153	—	313MR3	BE160L4	BX160L4	—	—	—	—	142000	166400	37700	370		
9.8	13400	1.6	149	310ML3	—	BE160L4	BX160L4	—	—	—	—	78000	98900	30400	344		
10.0	13100	1.0	146	307L3	—	BE160L4	BX160L4	—	—	30000	37500	67500	88800	20900	320		
10.0	13100	2.7	147	311ML3	—	BE160L4	BX160L4	—	—	—	—	98000	100000	30200	356		
10.0	13100	2.1	147	—	311MR3	BE160L4	BX160L4	—	—	—	—	98000	100000	30200	358		
10.6	12400	1.3	139	309L3	—	BE160L4	BX160L4	—	—	—	—	67900	87400	16400	334		
10.8	12100	2.1	135	310ML3	—	BE160L4	BX160L4	—	—	—	—	76200	96600	29400	344		
10.8	11800	1.9	136	—	310MR4	BE160L4	BX160L4	—	—	—	—	76300	96700	29400	346		

A

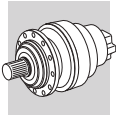

$P_1 = 15 \text{ kW}$

n_2 min ⁻¹	M_2 Nm	S	i	IE2		IE3		IE2		IE3		Rn ₂ [N]					
				BE160L4	BX160L4	BE160L4	BX160L4	MC	MZ	HC/PC	HZ/PZ	FZ					
11.0	11900	2.9	133	311ML3	—	BE160L4	BX160L4	—	—	—	—	95200	100000	29200	356		
11.6	11300	1.2	126	307L3	—	BE160L4	BX160L4	—	—	28500	35700	64500	84800	19900	320		
11.6	11300	1.5	126	309L3	—	BE160L4	BX160L4	—	—	—	—	65900	84800	15900	334		
12.2	10700	1.2	120	—	309R3	BE160L4	BX160L4	—	—	—	—	64900	83600	15600	332		
12.2	10700	1.6	120	—	310MR3	BE160L4	BX160L4	—	—	—	—	73400	93100	28200	346		
12.3	10600	2.0	119	310ML3	—	BE160L4	BX160L4	—	—	—	—	73300	92900	28200	344		
12.9	10100	1.0	113	307L3	—	BE160L4	BX160L4	—	—	27500	34400	62500	82200	19200	320		
12.9	10100	1.5	113	309L3	—	BE160L4	BX160L4	—	—	—	—	63900	82200	15300	334		
13.6	9640	2.5	108	310ML3	—	BE160L4	BX160L4	—	—	—	—	71100	90200	27200	344		
14.1	9320	1.0	104	306L3	—	BE160L4	BX160L4	—	—	22300	25400	51500	59400	14500	308		
14.5	9020	2.3	101	310ML3	—	BE160L4	BX160L4	—	—	—	—	69700	88400	26600	344		
14.6	8970	1.4	100	307L3	—	BE160L4	BX160L4	—	—	26400	33100	60200	79300	18400	320		
14.6	8970	1.8	100	309L3	—	BE160L4	BX160L4	—	—	—	—	61600	79300	14700	334		
14.8	8850	1.0	99.0	—	307R3	BE160L4	BX160L4	—	—	26300	32900	60000	78900	18300	322		
14.8	8850	1.4	99.0	—	309R3	BE160L4	BX160L4	—	—	—	—	61300	78900	14700	332		
14.8	8850	1.8	99.0	—	310MR3	BE160L4	BX160L4	—	—	—	—	69300	87900	26500	346		
15.8	8320	1.5	93.0	307L3	—	BE160L4	BX160L4	—	—	25800	32200	58900	77500	18000	320		
15.8	8320	1.8	93.0	309L3	—	BE160L4	BX160L4	—	—	—	—	60200	77500	14400	334		
15.8	8290	2.8	92.7	310ML3	—	BE160L4	BX160L4	—	—	—	—	68000	86200	25900	344		
16.6	7890	1.1	88.3	306L3	—	BE160L4	BX160L4	—	—	21100	24100	49000	56500	13700	308		
17.3	7580	1.0	84.7	—	306R3	BE160L4	BX160L4	—	—	20800	23700	48400	55800	13500	310		
17.6	7460	1.4	83.4	—	307R3	BE160L4	BX160L4	—	—	24900	31100	57000	75000	17300	322		
17.6	7460	1.9	83.4	—	309R3	BE160L4	BX160L4	—	—	—	—	58300	75000	13800	332		
17.6	7460	1.9	83.4	—	310MR3	BE160L4	BX160L4	—	—	—	—	65900	83500	25000	346		
17.9	7320	0.9	81.9	306L3	—	BE160L4	BX160L4	—	—	20600	23500	47900	55300	13400	308		
18.2	7210	1.4	80.6	307L3	—	BE160L4	BX160L4	—	—	24600	30700	56400	74200	17100	320		
18.2	7210	2.1	80.6	309L3	—	BE160L4	BX160L4	—	—	—	—	57700	74200	13700	334		
18.2	7180	2.9	80.3	310ML3	—	BE160L4	BX160L4	—	—	—	—	65100	82600	24700	344		
18.6	7030	1.6	78.6	—	307R3	BE160L4	BX160L4	—	—	24400	30500	56000	73700	17000	322		
18.6	7030	1.9	78.6	—	310MR3	BE160L4	BX160L4	—	—	—	—	64700	82100	24500	346		
19.0	6890	1.2	77.0	306L3	—	BE160L4	BX160L4	—	—	20200	23000	47000	54300	13100	308		
19.8	6630	1.8	74.1	307L3	—	BE160L4	BX160L4	—	—	23900	29900	55000	72400	16600	320		
19.8	6630	2.3	74.1	309L3	—	BE160L4	BX160L4	—	—	—	—	56200	72400	13300	334		
20.1	6520	1.1	72.9	—	306R3	BE160L4	BX160L4	—	—	19800	22600	46200	53400	12900	310		
20.4	6420	1.6	71.8	—	307R3	BE160L4	BX160L4	—	—	23600	29600	54500	71700	16500	322		
20.4	6420	2.0	71.8	—	309R3	BE160L4	BX160L4	—	—	—	—	55700	71700	13200	332		
20.4	6420	1.9	71.8	—	310MR3	BE160L4	BX160L4	—	—	—	—	63000	79800	23800	346		
21.7	6040	1.2	67.5	—	306R3	BE160L4	BX160L4	—	—	19300	22000	45200	52200	12500	310		
22.5	5830	1.3	65.2	306L3	—	BE160L4	BX160L4	—	—	19100	21800	44700	51600	12400	308		
22.5	5810	1.9	65.0	—	307R3	BE160L4	BX160L4	—	—	22900	28600	52900	69600	15900	322		
22.5	5810	1.9	65.0	—	309R3	BE160L4	BX160L4	—	—	—	—	54100	69600	12700	332		
22.5	5810	1.9	65.0	—	310MR3	BE160L4	BX160L4	—	—	—	—	61100	77500	23000	346		
24.2	5410	2.1	60.5	307L3	—	BE160L4	BX160L4	—	—	22300	27900	51800	68100	15600	320		
24.2	5410	2.6	60.5	309L3	—	BE160L4	BX160L4	—	—	—	—	52900	68100	12400	334		
25.2	5200	1.5	58.1	—	306R3	BE160L4	BX160L4	—	—	18400	20900	43200	49900	11900	310		
26.0	5190	1.0	56.3	306L2	—	BE160L4	BX160L4	ME5LA4	MX5LA4	18200	20700	42800	49400	11800	308		
26.2	5000	2.0	55.9	—	307R3	BE160L4	BX160L4	—	—	21800	27200	50600	66500	15200	322		
26.2	5000	2.0	55.9	—	309R3	BE160L4	BX160L4	—	—	—	—	51700	66500	12100	332		

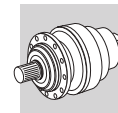

$P_1 = 15 \text{ kW}$

n_2 min ⁻¹	M_2 Nm	S	i	310MR3		BE160L4 BX160L4		ME5LA4 MX5LA4		R _{n2} [N]					Icon
				IE2	IE3	IE2	IE3	MC	MZ	HC/PC	HZ/PZ	FZ			
26.2	5000	1.9	55.9	—	310MR3	BE160L4	BX160L4	—	—	—	—	58400	74100	21900	346
27.5	4760	1.5	53.2	306L3	—	BE160L4	BX160L4	—	—	17800	20300	42100	48600	11600	308
28.6	4580	2.4	51.3	307L3	—	BE160L4	BX160L4	—	—	21100	26400	49300	64800	14700	320
28.6	4580	2.9	51.3	309L3	—	BE160L4	BX160L4	—	—	—	—	50400	64800	11800	334
31	4310	1.9	46.7	307L2	—	BE160L4	BX160L4	ME5LA4	MX5LA4	20500	25600	47900	63000	14300	320
31	4310	2.9	46.7	309L2	—	BE160L4	BX160L4	—	—	—	—	49000	63000	11400	334
32	4290	1.5	46.5	306L2	—	BE160L4	BX160L4	ME5LA4	MX5LA4	17100	19400	40400	46600	11100	308
32	4140	1.8	46.3	—	306R3	BE160L4	BX160L4	—	—	17000	19400	40300	46600	11100	310
33	3980	2.0	44.6	—	307R3	BE160L4	BX160L4	—	—	20200	25200	47200	62100	14000	322
33	3980	2.0	44.6	—	309R3	BE160L4	BX160L4	—	—	—	—	48300	62100	11200	332
33	3980	1.9	44.6	—	310MR3	BE160L4	BX160L4	—	—	—	—	54600	69200	20300	346
37	3510	1.9	39.2	—	306R3	BE160L4	BX160L4	—	—	16100	18400	38400	44300	10500	310
38	3540	1.2	38.4	305L2	—	BE160L4	BX160L4	—	—	13400	15400	27100	32100	7130	296
38	3540	1.8	38.4	306L2	—	BE160L4	BX160L4	ME5LA4	MX5LA4	16000	18200	38200	44000	10400	308
38	3560	2.3	38.6	307L2	—	BE160L4	BX160L4	ME5LA4	MX5LA4	19200	24000	45300	59500	13400	320
39	3380	2.0	37.7	—	307R3	BE160L4	BX160L4	—	—	19100	23900	44900	59100	13300	322
39	3380	2.0	37.7	—	309R3	BE160L4	BX160L4	—	—	—	—	45900	59100	10600	332
39	3380	1.9	37.7	—	310MR3	BE160L4	BX160L4	—	—	—	—	51900	65800	19200	346
41	3300	1.1	35.8	305L2	—	BE160L4	BX160L4	—	—	13100	15000	26500	31400	6960	296
44	3050	2.3	33.1	306L2	—	BE160L4	BX160L4	ME5LA4	MX5LA4	15200	17400	36500	42100	9890	308
44	2970	2.0	33.2	—	306R3	BE160L4	BX160L4	—	—	15200	17400	36500	42200	9910	310
46	2830	2.0	31.6	—	307R3	BE160L4	BX160L4	—	—	18000	22500	42600	56100	12500	322
46	2830	2.0	31.6	—	309R3	BE160L4	BX160L4	—	—	—	—	43600	56100	10000	332
48	2840	1.0	30.8	304L2	—	BE160L4	BX160L4	—	—	12500	14300	25400	30100	6620	284
48	2840	1.5	30.8	305L2	—	BE160L4	BX160L4	—	—	12500	14300	25400	30100	6620	296
52	2620	2.6	28.4	306L2	—	BE160L4	BX160L4	ME5LA4	MX5LA4	14500	16500	34900	40200	9410	308
55	2440	1.5	26.4	305L2	—	BE160L4	BX160L4	—	—	11900	13600	24200	28700	6290	296
56	2430	2.6	26.4	306L2	—	BE160L4	BX160L4	ME5LA4	MX5LA4	14100	16100	34100	39300	9170	308
60	2260	1.0	24.5	303L2	—	BE160L4	BX160L4	—	—	11600	13200	23700	28100	6140	272
60	2260	1.4	24.5	304L2	—	BE160L4	BX160L4	—	—	11600	13200	23700	28100	6140	284
60	2260	1.7	24.5	305L2	—	BE160L4	BX160L4	—	—	11600	13200	23700	28100	6140	296
64	2100	1.0	22.7	303L2	—	BE160L4	BX160L4	—	—	11300	12900	23200	27400	5990	272
64	2100	1.3	22.7	304L2	—	BE160L4	BX160L4	—	—	11300	12900	23200	27400	5990	284
64	2100	1.9	22.7	305L2	—	BE160L4	BX160L4	—	—	11300	12900	23200	27400	5990	296
65	2090	3.0	22.7	306L2	—	BE160L4	BX160L4	ME5LA4	MX5LA4	13400	15300	32600	37600	8720	308
71	1920	1.0	20.8	303L2	—	BE160L4	BX160L4	—	—	10900	12500	22500	26700	5810	272
71	1920	1.6	20.8	304L2	—	BE160L4	BX160L4	—	—	10900	12500	22500	26700	5810	284
71	1920	1.7	20.8	305L2	—	BE160L4	BX160L4	—	—	10900	12500	22500	26700	5810	296
76	1770	2.0	19.2	—	306R2	BE160L4	BX160L4	—	—	12700	14500	31000	35800	8250	310
81	1670	1.2	18.1	303L2	—	BE160L4	BX160L4	—	—	10500	12000	21600	25600	5550	272
81	1670	1.8	18.1	304L2	—	BE160L4	BX160L4	—	—	10500	12000	21600	25600	5550	284
81	1670	2.2	18.1	305L2	—	BE160L4	BX160L4	—	—	10500	12000	21600	25600	5550	296
92	1460	2.0	15.9	—	306R2	BE160L4	BX160L4	—	—	11900	13600	29300	33800	7750	310
95	1420	1.2	15.3	303L2	—	BE160L4	BX160L4	—	—	9900	11300	20600	24400	5250	272
95	1420	2.0	15.3	304L2	—	BE160L4	BX160L4	—	—	9900	11300	20600	24400	5250	284
95	1420	2.2	15.3	305L2	—	BE160L4	BX160L4	—	—	9900	11300	20600	24400	5250	296
107	1260	2.0	13.7	—	306R2	BE160L4	BX160L4	—	—	11300	12900	28000	32300	7370	310
117	1160	1.4	12.5	303L2	—	BE160L4	BX160L4	—	—	9250	10600	19400	23000	4910	272
117	1160	2.3	12.5	304L2	—	BE160L4	BX160L4	—	—	9250	10600	19400	23000	4910	284

A

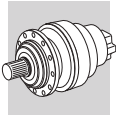

$P_1 = 15 \text{ kW}$

n_2 min ⁻¹	M_2 Nm	S	i	305L2		306R2		303L1		R_{n_2} [N]					
				IE2	IE3	IE2	IE3	MC	MZ	HC/PC	HZ/PZ	FZ			
117	1160	2.6	12.5	305L2	—	BE160L4	BX160L4	—	—	9250	10600	19400	23000	4910	296
135	1000	2.0	10.9	—	306R2	BE160L4	BX160L4	—	—	10500	12000	26100	30200	6830	310
159	850	2.0	9.23	—	306R2	BE160L4	BX160L4	—	—	9950	11300	24900	28700	6460	310
195	710	1.7	7.50	303L1	—	BE160L4	BX160L4	ME5LA4	MX5LA4	7800	8910	16600	19700	4140	272
236	590	2.4	6.20	303L1	—	BE160L4	BX160L4	ME5LA4	MX5LA4	7320	8360	15700	18600	3880	272
275	510	3.0	5.33	303L1	—	BE160L4	BX160L4	ME5LA4	MX5LA4	6960	7950	15000	17800	3690	272

$P_1 = 18.5 \text{ kW}$

n_2 min ⁻¹	M_2 Nm	S	i	317ML4		319L4		316ML4		317ML4		318ML4		317ML4		317ML4		318ML4		315ML4		314ML4		315ML4		316ML4		317ML4		315ML4		316ML4		317ML4		314ML4		315ML4		316ML4		317ML4		314ML4		315ML4	
				IE2	IE3	IE2	IE3	IE2	IE3	IE2	IE3	IE2	IE3	IE2	IE3	IE2	IE3	IE2	IE3	IE2	IE3	IE2	IE3	IE2	IE3	IE2	IE3	IE2	IE3	IE2	IE3	IE2	IE3	IE2	IE3	IE2	IE3	IE2	IE3	IE2	IE3	IE2	IE3				
0.92	170800	0.9	1595	317ML4	—	BE180M4	BX180M4	—	—	—	—	400400	425300	150000	414																																
1.1	141200	1.1	1318	317ML4	—	BE180M4	BX180M4	—	—	—	—	389600	413900	144800	414																																
1.1	148800	2.2	1389	319L4	—	BE180M4	BX180M4	—	—	—	—	453700	499600	196500	434																																
1.2	128000	2.7	1195	319L4	—	BE180M4	BX180M4	—	—	—	—	444100	488900	186800	434																																
1.3	118300	1.0	1104	316ML4	—	BE180M4	BX180M4	—	—	—	—	244200	273900	136500	404																																
1.3	121500	1.3	1134	317ML4	—	BE180M4	BX180M4	—	—	—	—	381300	405100	137700	414																																
1.4	109200	1.1	1020	316ML4	—	BE180M4	BX180M4	—	—	—	—	241400	270800	132900	404																																
1.4	110600	1.6	1032	317ML4	—	BE180M4	BX180M4	—	—	—	—	376300	399700	133500	414																																
1.4	113400	2.3	1059	318ML4	—	BE180M4	BX180M4	—	—	—	—	359200	405600	179500	424																																
1.5	102100	1.4	953	—	317MR4	BE180M4	BX180M4	—	—	—	—	372000	395200	130000	416																																
1.6	96800	1.6	904	317ML4	—	BE180M4	BX180M4	—	—	—	—	369200	392200	127700	414																																
1.6	97600	2.8	911	318ML4	—	BE180M4	BX180M4	—	—	—	—	351600	397000	170700	424																																
1.7	92300	1.1	862	315ML4	—	BE180M4	BX180M4	—	—	—	—	154000	184700	75400	392																																
1.7	94300	1.2	880	316ML4	—	BE180M4	BX180M4	—	—	—	—	236400	265100	126600	404																																
1.8	84800	2.3	792	317ML4	—	BE180M4	BX180M4	—	—	—	—	362300	384900	122200	414																																
1.8	86000	1.8	803	—	317MR4	BE180M4	BX180M4	—	—	—	—	363000	385600	122800	416																																
1.9	83800	1.0	782	—	315MR4	BE180M4	BX180M4	—	—	—	—	151900	182100	73000	394																																
1.9	84000	1.4	784	316ML4	—	BE180M4	BX180M4	—	—	—	—	232500	260800	121800	404																																
1.9	83800	1.4	782	—	316MR4	BE180M4	BX180M4	—	—	—	—	232400	260700	121700	406																																
2.0	79000	0.9	738	314ML4	—	BE180M4	BX180M4	—	—	—	—	150600	180600	71600	380																																
2.0	79400	1.2	741	315ML4	—	BE180M4	BX180M4	—	—	—	—	150700	180800	71700	392																																
2.0	77000	2.2	719	317ML4	—	BE180M4	BX180M4	—	—	—	—	357300	379600	118300	414																																
2.1	75700	1.5	706	316ML4	—	BE180M4	BX180M4	—	—	—	—	229100	257000	117600	404																																
2.2	71600	1.1	668	314ML4	—	BE180M4	BX180M4	—	—	—	—	148500	178100	69300	380																																
2.2	71900	1.3	672	315ML4	—	BE180M4	BX180M4	—	—	—	—	148600	178200	69400	392																																
2.2	70600	1.2	659	—	315MR4	BE180M4	BX180M4	—	—	—	—	148200	177700	69000	394																																
2.2	70600	1.6	659	—	316MR4	BE180M4	BX180M4	—	—	—	—	226800	254400	114900	406																																
2.2	72500	2.2	677	—	317MR4	BE180M4	BX180M4	—	—	—	—	354200	376300	116000	416																																
2.3	67300	1.7	628	316ML4	—	BE180M4	BX180M4	—	—	—	—	225200	252700	113100	404																																
2.3	67000	1.8	626	—	317MR4	BE180M4	BX180M4	—	—	—	—	350300	372100	113000	416																																
2.4	66800	1.4	623	—	315MR4	BE180M4	BX180M4	—	—	—	—	147000	176300	67700	394																																
2.4	66800	1.7	623	—	316MR4	BE180M4	BX180M4	—	—	—	—	225000	252400	112800	406																																
2.4	66300	2.5	619	317ML4	—	BE180M4	BX180M4	—	—	—	—	349700	371500	112500	414																																
2.5	61600	1.1	575	314ML4	—	BE180M4	BX180M4	—	—	—	—	145300	174300	65900	380																																
2.5	63000	1.2	588	314ML4	—	BE180M4	BX180M4	—	—	—	—	145800	174900	66400	380																																
2.5	63300	1.5	591	315ML4	—	BE180M4	BX180M4	—	—	—	—	145900	175000	66500	392																																

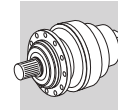

$P_1 = 18.5 \text{ kW}$

n ₂ min ⁻¹	M ₂ Nm	S	i	IE2		IE3		Rn ₂ [N]					Icon		
				BE180M4	BX180M4	IE2	IE3	MC	MZ	HC/PC	HZ/PZ	FZ			
2.6	60300	1.9	563	316ML4	—	BE180M4	BX180M4	—	—	—	—	221700	248800	109000	404
2.7	57100	1.7	533	315ML4	—	BE180M4	BX180M4	—	—	—	—	143800	172400	64300	392
2.8	56300	1.7	525	—	315MR4	BE180M4	BX180M4	—	—	—	—	143500	172100	63900	394
2.8	56300	2.2	525	—	316MR4	BE180M4	BX180M4	—	—	—	—	219600	246300	106600	406
2.8	55700	3.0	520	—	317MR4	BE180M4	BX180M4	—	—	—	—	341100	362400	106200	416
2.9	53600	2.3	500	316ML4	—	BE180M4	BX180M4	—	—	—	—	218100	244600	104900	404
3.0	53000	1.4	495	314ML4	—	BE180M4	BX180M4	—	—	—	—	142200	170600	62700	380
3.0	52100	1.8	487	315ML4	—	BE180M4	BX180M4	—	—	—	—	141900	170200	62300	392
3.2	49100	1.5	458	314ML4	—	BE180M4	BX180M4	—	—	—	—	140700	168700	61100	380
3.3	47200	2.0	441	315ML4	—	BE180M4	BX180M4	—	—	—	—	139900	167800	60300	392
3.3	47900	2.6	447	316ML4	—	BE180M4	BX180M4	—	—	—	—	214600	240700	101000	404
3.3	47400	2.6	443	—	316MR4	BE180M4	BX180M4	—	—	—	—	214300	240300	100600	406
3.4	46100	2.3	430	—	316MR4	BE180M4	BX180M4	—	—	—	—	213400	239400	99700	406
3.6	43800	2.2	409	—	315MR4	BE180M4	BX180M4	—	—	—	—	138500	166000	58800	394
3.7	42200	1.8	394	314ML4	—	BE180M4	BX180M4	—	—	—	—	137700	165100	58100	380
3.7	42700	2.4	399	316ML4	—	BE180M4	BX180M4	—	—	—	—	211100	236800	97200	404
4.0	39600	2.4	370	315ML4	—	BE180M4	BX180M4	—	—	—	—	136500	163600	56900	392
4.0	38800	2.7	363	—	316MR4	BE180M4	BX180M4	—	—	—	—	208300	233600	94200	406
4.2	36900	2.6	345	—	315MR4	BE180M4	BX180M4	—	—	—	—	135100	162000	55600	394
4.2	37000	2.8	346	316ML4	—	BE180M4	BX180M4	—	—	—	—	206800	232000	92700	404
4.3	36100	2.8	337	—	316MR4	BE180M4	BX180M4	—	—	—	—	206100	231200	91900	406
4.7	33600	2.2	314	314ML4	—	BE180M4	BX180M4	—	—	—	—	133300	159900	53900	380
4.8	33500	0.9	304	313ML3	—	BE180M4	BX180M4	—	—	—	—	142700	167300	47300	368
4.8	32400	2.9	302	315ML4	—	BE180M4	BX180M4	—	—	—	—	132600	159000	53200	392
5.8	27900	1.5	252	313ML3	—	BE180M4	BX180M4	—	—	—	—	142000	166400	44500	368
6.0	27100	1.3	245	311ML3	—	BE180M4	BX180M4	—	—	—	—	98000	100000	35800	356
6.1	26400	1.8	240	314ML3	—	BE180M4	BX180M4	—	—	—	—	132000	158300	49200	380
6.1	26600	2.2	241	315ML3	—	BE180M4	BX180M4	—	—	—	—	132000	158300	49300	392
7.0	23000	1.8	209	313ML3	—	BE180M4	BX180M4	—	—	—	—	142000	166400	41800	368
7.1	22800	2.7	206	314ML3	—	BE180M4	BX180M4	—	—	—	—	132000	158300	46800	380
7.2	22400	1.6	203	311ML3	—	BE180M4	BX180M4	—	—	—	—	98000	100000	33600	356
7.3	22300	1.0	202	310ML3	—	BE180M4	BX180M4	—	—	—	—	78000	98900	33600	344
7.6	21400	2.3	194	313ML3	—	BE180M4	BX180M4	—	—	—	—	142000	166400	40700	368
7.7	21100	1.5	191	311ML3	—	BE180M4	BX180M4	—	—	—	—	98000	100000	33000	356
8.0	20100	1.5	182	313ML3	—	BE180M4	BX180M4	—	—	—	—	142000	166400	39900	368
8.3	19600	0.9	177	310ML3	—	BE180M4	BX180M4	—	—	—	—	78000	98900	32100	344
8.3	19400	2.2	176	313ML3	—	BE180M4	BX180M4	—	—	—	—	142000	166400	39500	368
8.6	18900	1.9	171	311ML3	—	BE180M4	BX180M4	—	—	—	—	98000	100000	31800	356
9.0	18100	1.5	164	310ML3	—	BE180M4	BX180M4	—	—	—	—	78000	98900	31300	344
9.0	18000	2.8	163	313ML3	—	BE180M4	BX180M4	—	—	—	—	142000	166400	38500	368
9.1	17800	2.0	161	311ML3	—	BE180M4	BX180M4	—	—	—	—	98000	100000	31100	356
9.3	17300	2.7	157	—	314MR3C	BE180M4	BX180M4	—	—	—	—	132000	158300	42800	382
9.6	16900	1.8	153	—	313MR3	BE180M4	BX180M4	—	—	—	—	142000	166400	37700	370
9.7	16700	2.5	151	313ML3	—	BE180M4	BX180M4	—	—	—	—	142000	166400	37500	368
9.8	16500	1.3	149	310ML3	—	BE180M4	BX180M4	—	—	—	—	78000	98900	30400	344
10.0	16200	2.2	147	311ML3	—	BE180M4	BX180M4	—	—	—	—	98000	100000	30200	356
10.0	16200	1.7	147	—	311MR3	BE180M4	BX180M4	—	—	—	—	98000	100000	30200	358
10.2	15800	2.6	143	313ML3	—	BE180M4	BX180M4	—	—	—	—	141000	165200	36800	368
10.8	14900	1.7	135	310ML3	—	BE180M4	BX180M4	—	—	—	—	76200	96600	29400	344

A

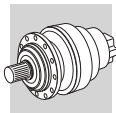

$P_1 = 18.5 \text{ kW}$

n_2 min ⁻¹	M_2 Nm	S	i	[Image]		[Image]		[Image]		R _{n2} [N]					[Icon]
				IE2	IE3	IE2	IE3	MC	MZ	HC/PC	HZ/PZ	FZ			
11.0	14700	2.4	133	311ML3	—	BE180M4	BX180M4	—	—	—	—	95200	100000	29200	356
11.5	14000	2.9	127	—	313MR3	BE180M4	BX180M4	—	—	—	—	136100	159500	35400	370
11.9	13600	2.5	124	—	311MR3	BE180M4	BX180M4	—	—	—	—	93100	100000	28500	358
12.3	13100	1.6	119	310ML3	—	BE180M4	BX180M4	—	—	—	—	73300	92900	28200	344
12.8	12600	2.7	115	311ML3	—	BE180M4	BX180M4	—	—	—	—	91000	100000	27800	356
13.6	11900	2.1	108	310ML3	—	BE180M4	BX180M4	—	—	—	—	71100	90200	27200	344
14.1	11500	2.9	104	—	311MR3	BE180M4	BX180M4	—	—	—	—	88500	100000	26900	358
14.5	11100	1.9	101	310ML3	—	BE180M4	BX180M4	—	—	—	—	69700	88400	26600	344
15.2	10600	2.8	96.3	—	311MR3	BE180M4	BX180M4	—	—	—	—	86400	100000	26200	358
15.8	10200	2.3	92.7	310ML3	—	BE180M4	BX180M4	—	—	—	—	68000	86200	25900	344
18.2	8870	2.3	80.3	310ML3	—	BE180M4	BX180M4	—	—	—	—	65100	82600	24700	344
19.8	8160	2.7	73.9	310ML3	—	BE180M4	BX180M4	—	—	—	—	63500	80500	24000	344
23.4	6910	2.9	62.6	310ML3	—	BE180M4	BX180M4	—	—	—	—	60400	76600	22700	344
31	5320	1.6	46.7	307L2	—	BE180M4	BX180M4	—	—	20500	25600	47900	63000	14300	320
31	5320	2.4	46.7	309L2	—	BE180M4	BX180M4	—	—	—	—	49000	63000	11400	334
32	5290	1.2	46.5	306L2	—	BE180M4	BX180M4	—	—	17100	19400	40400	46600	11100	308
38	4380	1.5	38.4	306L2	—	BE180M4	BX180M4	—	—	16000	18200	38200	44000	10400	308
38	4400	1.9	38.6	307L2	—	BE180M4	BX180M4	—	—	19200	24000	45300	59500	13400	320
38	4400	2.8	38.6	309L2	—	BE180M4	BX180M4	—	—	—	—	46300	59500	10700	334
44	3760	1.8	33.1	306L2	—	BE180M4	BX180M4	—	—	15200	17400	36500	42100	9890	308
45	3710	2.5	32.6	307L2	—	BE180M4	BX180M4	—	—	18200	22700	43000	56500	12700	320
48	3490	2.8	30.7	307L2	—	BE180M4	BX180M4	—	—	17800	22300	42200	55600	12400	320
52	3240	2.1	28.4	306L2	—	BE180M4	BX180M4	—	—	14500	16500	34900	40200	9410	308
52	3190	2.9	28.0	307L2	—	BE180M4	BX180M4	—	—	17300	21600	41100	54100	12000	320
56	3000	2.1	26.4	306L2	—	BE180M4	BX180M4	—	—	14100	16100	34100	39300	9170	308
62	2680	3.0	23.5	—	307R2	BE180M4	BX180M4	—	—	16300	20400	39000	51300	11400	322
65	2580	2.4	22.7	306L2	—	BE180M4	BX180M4	—	—	13400	15300	32600	37600	8720	308
81	2060	2.9	18.1	306L2	—	BE180M4	BX180M4	—	—	12400	14200	30400	35100	8090	308
96	1740	2.9	15.3	306L2	—	BE180M4	BX180M4	—	—	11800	13400	28900	33400	7650	308
195	880	1.4	7.50	303L1	—	BE180M4	BX180M4	—	—	7800	8910	16600	19700	4140	272
195	880	2.6	7.50	305L1	—	BE180M4	BX180M4	—	—	7800	8910	16600	19700	4140	296
223	770	2.4	6.57	304L1	—	BE180M4	BX180M4	—	—	7460	8530	16000	18900	3960	284
236	730	1.9	6.20	303L1	—	BE180M4	BX180M4	—	—	7320	8360	15700	18600	3880	272
275	630	2.4	5.33	303L1	—	BE180M4	BX180M4	—	—	6960	7950	15000	17800	3690	272
345	500	2.9	4.25	303L1	—	BE180M4	BX180M4	—	—	6450	7370	14000	16600	3420	272

$P_1 = 22 \text{ kW}$

n_2 min ⁻¹	M_2 Nm	S	i	[Image]		[Image]		[Image]		R _{n2} [N]					[Icon]
				IE2	IE3	IE2	IE3	MC	MZ	HC/PC	HZ/PZ	FZ			
1.1	166900	0.9	1318	317ML4	—	BE180L4	BX180L4	—	—	—	—	389600	413900	144800	414
1.1	175800	1.9	1389	319L4	—	BE180L4	BX180L4	—	—	—	—	453700	499600	196500	434
1.2	151200	2.3	1195	319L4	—	BE180L4	BX180L4	—	—	—	—	444100	488900	186800	434
1.3	143600	1.1	1134	317ML4	—	BE180L4	BX180L4	—	—	—	—	381300	405100	137700	414
1.4	129100	0.9	1020	316ML4	—	BE180L4	BX180L4	—	—	—	—	241400	270800	132900	404
1.4	130700	1.3	1032	317ML4	—	BE180L4	BX180L4	—	—	—	—	376300	399700	133500	414
1.4	134100	2.0	1059	318ML4	—	BE180L4	BX180L4	—	—	—	—	359200	405600	179500	424
1.5	120700	1.2	953	—	317MR4	BE180L4	BX180L4	—	—	—	—	372000	395200	130000	416

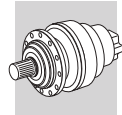

$P_1 = 22 \text{ kW}$

n ₂ min ⁻¹	M ₂ Nm	S	i	[Icons]		IE2		IE3		Rn ₂ [N]					[Icon]
				[Icon]	[Icon]	[Icon]	[Icon]	IE2	IE3	MC	MZ	HC/PC	HZ/PZ	FZ	
1.5	127400	2.6	1007	319L4	—	BE180L4	BX180L4	—	—	—	—	433300	477100	176500	434
1.6	114400	1.4	904	317ML4	—	BE180L4	BX180L4	—	—	—	—	369200	392200	127700	414
1.6	115300	2.4	911	318ML4	—	BE180L4	BX180L4	—	—	—	—	351600	397000	170700	424
1.6	115400	2.8	912	319L4	—	BE180L4	BX180L4	—	—	—	—	427300	470400	170800	434
1.6	114700	2.8	906	—	319R4C	BE180L4	BX180L4	—	—	—	—	426900	470000	170400	436
1.7	111400	1.0	880	316ML4	—	BE180L4	BX180L4	—	—	—	—	236400	265100	126600	404
1.8	100300	1.9	792	317ML4	—	BE180L4	BX180L4	—	—	—	—	362300	384900	122200	414
1.8	101700	1.5	803	—	317MR4	BE180L4	BX180L4	—	—	—	—	363000	385600	122800	416
1.9	99300	1.2	784	316ML4	—	BE180L4	BX180L4	—	—	—	—	232500	260800	121800	404
1.9	99000	1.2	782	—	316MR4	BE180L4	BX180L4	—	—	—	—	232400	260700	121700	406
1.9	97200	2.8	768	318ML4	—	BE180L4	BX180L4	—	—	—	—	343100	387400	161200	424
2.0	93900	1.0	741	315ML4	—	BE180L4	BX180L4	—	—	—	—	150700	180800	71700	392
2.0	91000	1.9	719	317ML4	—	BE180L4	BX180L4	—	—	—	—	357300	379600	118300	414
2.0	91900	2.9	726	318ML4	—	BE180L4	BX180L4	—	—	—	—	340400	384300	158300	424
2.1	89400	1.3	706	316ML4	—	BE180L4	BX180L4	—	—	—	—	229100	257000	117600	404
2.1	87500	2.9	691	—	318MR4C	BE180L4	BX180L4	—	—	—	—	338000	381600	155700	426
2.2	84600	0.9	668	314ML4	—	BE180L4	BX180L4	—	—	—	—	148500	178100	69300	380
2.2	85000	1.1	672	315ML4	—	BE180L4	BX180L4	—	—	—	—	148600	178200	69400	392
2.2	83400	1.0	659	—	315MR4	BE180L4	BX180L4	—	—	—	—	148200	177700	69000	394
2.2	83400	1.3	659	—	316MR4	BE180L4	BX180L4	—	—	—	—	226800	254400	114900	406
2.2	85700	1.8	677	—	317MR4	BE180L4	BX180L4	—	—	—	—	354200	376300	116000	416
2.3	79500	1.4	628	316ML4	—	BE180L4	BX180L4	—	—	—	—	225200	252700	113100	404
2.3	79200	1.5	626	—	317MR4	BE180L4	BX180L4	—	—	—	—	350300	372100	113000	416
2.4	78900	1.2	623	—	315MR4	BE180L4	BX180L4	—	—	—	—	147000	176300	67700	394
2.4	78900	1.4	623	—	316MR4	BE180L4	BX180L4	—	—	—	—	225000	252400	112800	406
2.4	78300	2.1	619	317ML4	—	BE180L4	BX180L4	—	—	—	—	349700	371500	112500	414
2.5	72800	0.9	575	314ML4	—	BE180L4	BX180L4	—	—	—	—	145300	174300	65900	380
2.5	74400	1.0	588	314ML4	—	BE180L4	BX180L4	—	—	—	—	145800	174900	66400	380
2.5	74800	1.3	591	315ML4	—	BE180L4	BX180L4	—	—	—	—	145900	175000	66500	392
2.6	71300	1.6	563	316ML4	—	BE180L4	BX180L4	—	—	—	—	221700	248800	109000	404
2.7	67500	1.4	533	315ML4	—	BE180L4	BX180L4	—	—	—	—	143800	172400	64300	392
2.7	69800	2.8	552	317ML4	—	BE180L4	BX180L4	—	—	—	—	344000	365500	108300	414
2.8	66500	1.4	525	—	315MR4	BE180L4	BX180L4	—	—	—	—	143500	172100	63900	394
2.8	66500	1.9	525	—	316MR4	BE180L4	BX180L4	—	—	—	—	219600	246300	106600	406
2.8	65800	2.5	520	—	317MR4	BE180L4	BX180L4	—	—	—	—	341100	362400	106200	416
2.9	63400	2.0	500	316ML4	—	BE180L4	BX180L4	—	—	—	—	218100	244600	104900	404
3.0	62600	1.2	495	314ML4	—	BE180L4	BX180L4	—	—	—	—	142200	170600	62700	380
3.0	61600	1.5	487	315ML4	—	BE180L4	BX180L4	—	—	—	—	141900	170200	62300	392
3.0	62400	2.7	493	317ML4	—	BE180L4	BX180L4	—	—	—	—	338500	359700	104300	414
3.2	58000	1.3	458	314ML4	—	BE180L4	BX180L4	—	—	—	—	140700	168700	61100	380
3.3	55800	1.7	441	315ML4	—	BE180L4	BX180L4	—	—	—	—	139900	167800	60300	392
3.3	56600	2.2	447	316ML4	—	BE180L4	BX180L4	—	—	—	—	214600	240700	101000	404
3.3	56000	2.2	443	—	316MR4	BE180L4	BX180L4	—	—	—	—	214300	240300	100600	406
3.3	55500	2.8	438	—	317MR4	BE180L4	BX180L4	—	—	—	—	332900	353700	100300	416
3.4	54500	1.9	430	—	316MR4	BE180L4	BX180L4	—	—	—	—	213400	239400	99700	406
3.6	51800	1.8	409	—	315MR4	BE180L4	BX180L4	—	—	—	—	138500	166000	58800	394
3.7	49900	1.5	394	314ML4	—	BE180L4	BX180L4	—	—	—	—	137700	165100	58100	380
3.7	50500	2.1	399	316ML4	—	BE180L4	BX180L4	—	—	—	—	211100	236800	97200	404
3.7	50500	3.0	399	—	317MR4	BE180L4	BX180L4	—	—	—	—	328500	349000	97200	416
4.0	46800	2.0	370	315ML4	—	BE180L4	BX180L4	—	—	—	—	136500	163600	56900	392

A

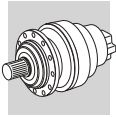

$P_1 = 22 \text{ kW}$

n_2 min ⁻¹	M_2 Nm	S	i	IE2		IE3		IE2		IE3		Rn ₂ [N]					
				MC	MZ	HC/PC	HZ/PZ	FZ									
4.0	45900	2.2	363	—	316MR4	BE180L4	BX180L4	—	—	—	—	208300	233600	94200	406		
4.2	43700	2.2	345	—	315MR4	BE180L4	BX180L4	—	—	—	—	135100	162000	55600	394		
4.2	43800	2.3	346	316ML4	—	BE180L4	BX180L4	—	—	—	—	206800	232000	92700	404		
4.3	42700	2.4	337	—	316MR4	BE180L4	BX180L4	—	—	—	—	206100	231200	91900	406		
4.4	42600	3.0	336	—	317MR4	BE180L4	BX180L4	—	—	—	—	320500	340500	91800	416		
4.7	39800	1.9	314	314ML4	—	BE180L4	BX180L4	—	—	—	—	133300	159900	53900	380		
4.8	38300	2.5	302	315ML4	—	BE180L4	BX180L4	—	—	—	—	132600	159000	53200	392		
5.1	36600	3.0	289	—	316MR4	BE180L4	BX180L4	—	—	—	—	202000	226600	87300	406		
5.5	34000	2.7	269	—	315MR4	BE180L4	BX180L4	—	—	—	—	132000	158300	51100	394		
5.5	34000	3.0	269	—	316MR4	BE180L4	BX180L4	—	—	—	—	202000	226600	85200	406		
5.6	33200	3.0	262	—	317MR4	BE180L4	BX180L4	—	—	—	—	314300	333900	84500	416		
5.8	32900	1.3	252	313ML3	—	BE180L4	BX180L4	—	—	—	—	142000	166400	44500	368		
6.0	32000	1.1	245	311ML3	—	BE180L4	BX180L4	—	—	—	—	98000	100000	35800	356		
6.1	31300	1.5	240	314ML3	—	BE180L4	BX180L4	—	—	—	—	132000	158300	49200	380		
6.1	31400	1.9	241	315ML3	—	BE180L4	BX180L4	—	—	—	—	132000	158300	49300	392		
6.5	28500	3.0	225	—	315MR4	BE180L4	BX180L4	—	—	—	—	132000	158300	48200	394		
6.5	28500	3.0	225	—	316MR4	BE180L4	BX180L4	—	—	—	—	202000	226600	80400	406		
6.7	27800	3.0	220	—	317MR4	BE180L4	BX180L4	—	—	—	—	314300	333900	79700	416		
7.0	27200	1.6	209	313ML3	—	BE180L4	BX180L4	—	—	—	—	142000	166400	41800	368		
7.1	26900	2.3	206	314ML3	—	BE180L4	BX180L4	—	—	—	—	132000	158300	46800	380		
7.1	27000	2.8	207	315ML3	—	BE180L4	BX180L4	—	—	—	—	132000	158300	46900	392		
7.2	26500	1.4	203	311ML3	—	BE180L4	BX180L4	—	—	—	—	98000	100000	33600	356		
7.6	25300	1.9	194	313ML3	—	BE180L4	BX180L4	—	—	—	—	142000	166400	40700	368		
7.7	25000	1.3	191	311ML3	—	BE180L4	BX180L4	—	—	—	—	98000	100000	33000	356		
8.0	23800	1.3	182	313ML3	—	BE180L4	BX180L4	—	—	—	—	142000	166400	39900	368		
8.3	22900	1.8	176	313ML3	—	BE180L4	BX180L4	—	—	—	—	142000	166400	39500	368		
8.4	22700	2.7	174	314ML3	—	BE180L4	BX180L4	—	—	—	—	132000	158300	44200	380		
8.6	22300	1.6	171	311ML3	—	BE180L4	BX180L4	—	—	—	—	98000	100000	31800	356		
8.9	21400	2.8	164	314ML3	—	BE180L4	BX180L4	—	—	—	—	132000	158300	43400	380		
9.0	21400	1.2	164	310ML3	—	BE180L4	BX180L4	—	—	—	—	78000	98900	31300	344		
9.0	21300	2.4	163	313ML3	—	BE180L4	BX180L4	—	—	—	—	142000	166400	38500	368		
9.1	21000	1.7	161	311ML3	—	BE180L4	BX180L4	—	—	—	—	98000	100000	31100	356		
9.3	20500	2.3	157	—	314MR3C	BE180L4	BX180L4	—	—	—	—	132000	158300	42800	382		
9.3	20500	2.9	157	—	315MR3C	BE180L4	BX180L4	—	—	—	—	132000	158300	42800	394		
9.6	20000	1.5	153	—	313MR3	BE180L4	BX180L4	—	—	—	—	142000	166400	37700	370		
9.7	19700	2.1	151	313ML3	—	BE180L4	BX180L4	—	—	—	—	142000	166400	37500	368		
9.8	19500	1.1	149	310ML3	—	BE180L4	BX180L4	—	—	—	—	78000	98900	30400	344		
10.0	19200	1.8	147	311ML3	—	BE180L4	BX180L4	—	—	—	—	98000	100000	30200	356		
10.0	19100	1.4	147	—	311MR3	BE180L4	BX180L4	—	—	—	—	98000	100000	30200	358		
10.2	18700	2.2	143	313ML3	—	BE180L4	BX180L4	—	—	—	—	141000	165200	36800	368		
10.8	17700	1.5	135	310ML3	—	BE180L4	BX180L4	—	—	—	—	76200	96600	29400	344		
10.9	17600	2.8	135	313ML3	—	BE180L4	BX180L4	—	—	—	—	138500	162300	36100	368		
11.0	17400	2.0	133	311ML3	—	BE180L4	BX180L4	—	—	—	—	95200	100000	29200	356		
11.5	16600	2.4	127	—	313MR3	BE180L4	BX180L4	—	—	—	—	136100	159500	35400	370		
11.9	16100	2.1	124	—	311MR3	BE180L4	BX180L4	—	—	—	—	93100	100000	28500	358		
12.2	15700	2.6	120	313ML3	—	BE180L4	BX180L4	—	—	—	—	133900	156900	34800	368		
12.3	15500	1.4	119	310ML3	—	BE180L4	BX180L4	—	—	—	—	73300	92900	28200	344		
12.8	14900	2.3	115	311ML3	—	BE180L4	BX180L4	—	—	—	—	91000	100000	27800	356		
13.6	14100	1.7	108	310ML3	—	BE180L4	BX180L4	—	—	—	—	71100	90200	27200	344		
13.7	14000	2.7	107	—	313MR3	BE180L4	BX180L4	—	—	—	—	129300	151500	33500	370		

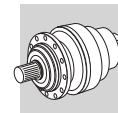

$P_1 = 22 \text{ kW}$

n ₂ min ⁻¹	M ₂ Nm	S	i	IE2		IE3		IE2		IE3		Rn ₂ [N]					📄
				MC	MZ	HC/PC	HZ/PZ	FZ									
14.1	13500	2.7	104	311ML3	—	BE180L4	BX180L4	—	—	—	—	88400	100000	26900	356		
14.1	13600	2.4	104	—	311MR3	BE180L4	BX180L4	—	—	—	—	88500	100000	26900	358		
14.5	13200	1.6	101	310ML3	—	BE180L4	BX180L4	—	—	—	—	69700	88400	26600	344		
15.0	12700	3.0	97.5	—	313MR3	BE180L4	BX180L4	—	—	—	—	125700	147300	32400	370		
15.2	12600	2.4	96.3	—	311MR3	BE180L4	BX180L4	—	—	—	—	86400	100000	26200	358		
15.8	12100	1.9	92.7	310ML3	—	BE180L4	BX180L4	—	—	—	—	68000	86200	25900	344		
16.4	11600	3.0	89.3	311ML3	—	BE180L4	BX180L4	—	—	—	—	84500	100000	25600	356		
17.8	10700	3.0	82.2	—	313MR3	BE180L4	BX180L4	—	—	—	—	119400	139900	30600	370		
18.1	10600	2.8	81.1	—	311MR3	BE180L4	BX180L4	—	—	—	—	82100	100000	24800	358		
18.2	10500	2.0	80.3	310ML3	—	BE180L4	BX180L4	—	—	—	—	65100	82600	24700	344		
19.8	9640	2.3	73.9	310ML3	—	BE180L4	BX180L4	—	—	—	—	63500	80500	24000	344		
20.9	9130	3.0	69.9	—	313MR3	BE180L4	BX180L4	—	—	—	—	113800	133300	29000	370		
21.5	8870	3.0	68.0	—	311MR3	BE180L4	BX180L4	—	—	—	—	77800	99300	23400	358		
22.9	8360	3.0	64.0	—	313MR3	BE180L4	BX180L4	—	—	—	—	110800	129800	28200	370		
23.2	8250	3.0	63.2	—	311MR3	BE180L4	BX180L4	—	—	—	—	76200	97100	22800	358		
23.4	8170	2.4	62.6	310ML3	—	BE180L4	BX180L4	—	—	—	—	60400	76600	22700	344		
27.3	7000	3.0	53.7	—	313MR3	BE180L4	BX180L4	—	—	—	—	105100	123100	26600	370		
27.6	6920	2.8	53.0	310ML3	—	BE180L4	BX180L4	—	—	—	—	57500	72900	21500	344		
27.6	6920	3.0	53.0	—	311MR3	BE180L4	BX180L4	—	—	—	—	72200	92100	21500	358		
31	6290	1.3	46.7	307L2	—	BE180L4	BX180L4	—	—	20500	25600	47900	63000	14300	320		
31	6290	2.0	46.7	309L2	—	BE180L4	BX180L4	—	—	—	—	49000	63000	11400	334		
31	6290	2.8	46.7	310ML2	—	BE180L4	BX180L4	—	—	—	—	55400	70200	20600	344		
32	6260	1.0	46.5	306L2	—	BE180L4	BX180L4	—	—	17100	19400	40400	46600	11100	308		
38	5170	1.3	38.4	306L2	—	BE180L4	BX180L4	—	—	16000	18200	38200	44000	10400	308		
38	5200	1.6	38.6	307L2	—	BE180L4	BX180L4	—	—	19200	24000	45300	59500	13400	320		
38	5200	2.4	38.6	309L2	—	BE180L4	BX180L4	—	—	—	—	46300	59500	10700	334		
44	4450	1.5	33.1	306L2	—	BE180L4	BX180L4	—	—	15200	17400	36500	42100	9890	308		
45	4380	2.2	32.6	307L2	—	BE180L4	BX180L4	—	—	18200	22700	43000	56500	12700	320		
45	4380	3.0	32.6	309L2	—	BE180L4	BX180L4	—	—	—	—	43900	56500	10100	334		
48	4130	2.3	30.7	307L2	—	BE180L4	BX180L4	—	—	17800	22300	42200	55600	12400	320		
52	3830	1.8	28.4	306L2	—	BE180L4	BX180L4	—	—	14500	16500	34900	40200	9410	308		
52	3770	2.4	28.0	307L2	—	BE180L4	BX180L4	—	—	17300	21600	41100	54100	12000	320		
56	3550	1.8	26.4	306L2	—	BE180L4	BX180L4	—	—	14100	16100	34100	39300	9170	308		
58	3410	2.7	25.4	307L2	—	BE180L4	BX180L4	—	—	16700	20900	39900	52500	11600	320		
62	3170	2.5	23.5	—	307R2	BE180L4	BX180L4	—	—	16300	20400	39000	51300	11400	322		
62	3170	3.0	23.5	—	309R2	BE180L4	BX180L4	—	—	—	—	39900	51300	9080	332		
65	3050	2.0	22.7	306L2	—	BE180L4	BX180L4	—	—	13400	15300	32600	37600	8720	308		
67	2940	3.0	21.8	307L2	—	BE180L4	BX180L4	—	—	15900	19900	38100	50200	11100	320		
74	2670	3.0	19.8	—	307R2	BE180L4	BX180L4	—	—	15400	19300	37000	48700	10700	322		
74	2670	3.0	19.8	—	309R2	BE180L4	BX180L4	—	—	—	—	37900	48700	8580	332		
81	2430	2.4	18.1	306L2	—	BE180L4	BX180L4	—	—	12400	14200	30400	35100	8090	308		
95	2080	3.0	15.5	—	307R2	BE180L4	BX180L4	—	—	14200	17700	34400	45200	9870	322		
95	2080	3.0	15.5	—	309R2	BE180L4	BX180L4	—	—	—	—	35100	45200	7900	332		
96	2060	2.4	15.3	306L2	—	BE180L4	BX180L4	—	—	11800	13400	28900	33400	7650	308		
113	1740	2.8	13.0	306L2	—	BE180L4	BX180L4	—	—	11100	12700	27500	31800	7240	308		
113	1740	3.0	13.0	—	307R2	BE180L4	BX180L4	—	—	13400	16700	32600	42900	9310	322		
113	1740	3.0	13.0	—	309R2	BE180L4	BX180L4	—	—	—	—	33300	42900	7440	332		
195	1040	1.2	7.50	303L1	—	BE180L4	BX180L4	—	—	7800	8910	16600	19700	4140	272		
195	1040	2.2	7.50	305L1	—	BE180L4	BX180L4	—	—	7800	8910	16600	19700	4140	296		
223	910	2.1	6.57	304L1	—	BE180L4	BX180L4	—	—	7460	8530	16000	18900	3960	284		

A

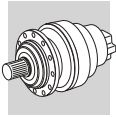

$P_1 = 22 \text{ kW}$

n_2 min ⁻¹	M_2 Nm	S	i	[Icons]		IE2		IE3		Rn ₂ [N]					[Icon]
				[Icon]	[Icon]	[Icon]	[Icon]	IE2	IE3	MC	MZ	HC/PC	HZ/PZ	FZ	
236	860	1.6	6.20	303L1	—	BE180L4	BX180L4	—	—	7320	8360	15700	18600	3880	272
275	740	2.0	5.33	303L1	—	BE180L4	BX180L4	—	—	6960	7950	15000	17800	3690	272
275	740	2.7	5.33	304L1	—	BE180L4	BX180L4	—	—	6960	7950	15000	17800	3690	284
345	590	2.4	4.25	303L1	—	BE180L4	BX180L4	—	—	6450	7370	14000	16600	3420	272
407	500	2.8	3.60	303L1	—	BE180L4	BX180L4	—	—	6110	6980	13300	15800	3240	272

$P_1 = 30 \text{ kW}$

n_2 min ⁻¹	M_2 Nm	S	i	[Icons]		IE2*		IE3		Rn ₂ [N]					[Icon]
				[Icon]	[Icon]	IE2*	IE3	IE2	IE3	MC	MZ	HC/PC	HZ/PZ	FZ	
1.1	239700	1.4	1389	319L4	—	IEC200L4	BX200LA4	—	—	—	—	453500	499300	196200	434
1.2	206200	1.7	1195	319L4	—	IEC200L4	BX200LA4	—	—	—	—	443900	488700	186600	434
1.3	193600	2.7	1122	321L4	—	IEC200L4	BX200LA4	—	—	—	—	622200	740600	1106400	444
1.4	178200	1.0	1032	317ML4	—	IEC200L4	BX200LA4	—	—	—	—	376100	399500	133300	414
1.4	182800	1.4	1059	318ML4	—	IEC200L4	BX200LA4	—	—	—	—	359100	405400	179300	424
1.5	173800	1.9	1007	319L4	—	IEC200L4	BX200LA4	—	—	—	—	433100	476900	176300	434
1.6	156000	1.0	904	317ML4	—	IEC200L4	BX200LA4	—	—	—	—	369000	392000	127500	414
1.6	157300	1.8	911	318ML4	—	IEC200L4	BX200LA4	—	—	—	—	351400	396800	170500	424
1.6	157400	2.0	912	319L4	—	IEC200L4	BX200LA4	—	—	—	—	427100	470200	170600	434
1.6	156500	2.0	906	—	319R4C	IEC200L4	BX200LA4	—	—	—	—	426700	469800	170200	436
1.7	146800	2.8	850	319L4	—	IEC200L4	BX200LA4	—	—	—	—	422800	465500	166700	434
1.8	138700	1.1	803	—	317MR4	IEC200L4	BX200LA4	—	—	—	—	362800	385500	122600	416
1.8	138500	2.3	802	319L4	—	IEC200L4	BX200LA4	—	—	—	—	419300	461700	163400	434
1.9	136700	1.4	792	317ML4	—	IEC200L4	BX200LA4	—	—	—	—	362100	384700	122100	414
1.9	132500	2.0	768	318ML4	—	IEC200L4	BX200LA4	—	—	—	—	342900	387200	161100	424
1.9	134600	2.4	780	—	319R4C	IEC200L4	BX200LA4	—	—	—	—	417600	459800	161900	436
2.0	124100	1.4	719	317ML4	—	IEC200L4	BX200LA4	—	—	—	—	357100	379400	118200	414
2.0	125300	2.1	726	318ML4	—	IEC200L4	BX200LA4	—	—	—	—	340200	384100	158100	424
2.1	121900	0.9	706	316ML4	—	IEC200L4	BX200LA4	—	—	—	—	228900	256800	117500	404
2.1	119300	2.2	691	—	318MR4C	IEC200L4	BX200LA4	—	—	—	—	337800	381500	155500	426
2.2	113800	1.0	659	—	316MR4	IEC200L4	BX200LA4	—	—	—	—	226700	254300	114800	406
2.2	116800	1.3	677	—	317MR4	IEC200L4	BX200LA4	—	—	—	—	354100	376100	115800	416
2.2	113000	2.7	655	—	319R4B	IEC200L4	BX200LA4	—	—	—	—	407300	448500	152700	436
2.2	113400	2.7	657	—	319R4C	IEC200L4	BX200LA4	—	—	—	—	407500	448700	152900	436
2.3	108400	1.0	628	316ML4	—	IEC200L4	BX200LA4	—	—	—	—	225100	252600	113000	404
2.3	108100	1.1	626	—	317MR4	IEC200L4	BX200LA4	—	—	—	—	350100	372000	112800	416
2.3	111700	2.4	647	318ML4	—	IEC200L4	BX200LA4	—	—	—	—	334600	377900	152100	424
2.4	107600	1.1	623	—	316MR4	IEC200L4	BX200LA4	—	—	—	—	224900	252300	112700	406
2.4	106800	1.6	619	317ML4	—	IEC200L4	BX200LA4	—	—	—	—	349500	371300	112400	414
2.4	105600	2.5	612	318ML4	—	IEC200L4	BX200LA4	—	—	—	—	332000	374900	149300	424
2.4	107900	2.9	625	319L4	—	IEC200L4	BX200LA4	—	—	—	—	404600	445500	150400	434
2.5	102000	0.9	591	315ML4	—	IEC200L4	BX200LA4	—	—	—	—	145800	174900	66400	392
2.5	102600	2.5	595	—	318MR4C	IEC200L4	BX200LA4	—	—	—	—	330700	373300	147900	426
2.6	97200	1.2	563	316ML4	—	IEC200L4	BX200LA4	—	—	—	—	221600	248600	108900	404
2.7	95200	2.0	552	317ML4	—	IEC200L4	BX200LA4	—	—	—	—	343900	365300	108200	414
2.8	92100	1.0	533	315ML4	—	IEC200L4	BX200LA4	—	—	—	—	143700	172400	64200	392
2.8	90700	1.0	525	—	315MR4	IEC200L4	BX200LA4	—	—	—	—	143400	172000	63900	394
2.8	90700	1.4	525	—	316MR4	IEC200L4	BX200LA4	—	—	—	—	219500	246200	106400	406
2.8	89800	1.9	520	—	317MR4	IEC200L4	BX200LA4	—	—	—	—	341000	362200	106100	416
2.9	86400	1.5	500	316ML4	—	IEC200L4	BX200LA4	—	—	—	—	218000	244500	104700	404
2.9	89000	2.9	515	318ML4	—	IEC200L4	BX200LA4	—	—	—	—	324000	365800	141000	424
2.9	86200	2.9	499	—	318MR4B	IEC200L4	BX200LA4	—	—	—	—	322500	364100	139500	426
2.9	86500	2.9	501	—	318MR4C	IEC200L4	BX200LA4	—	—	—	—	322700	364300	139700	426

* The technical information shall be considered as indicative, the configurations should be matching the data provided by motors manufacturers on rated powers greater than 22 kW.

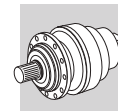

$P_1 = 30 \text{ kW}$

n ₂ min ⁻¹	M ₂ Nm	S	i	IE2*		IE3		IE2		IE3		Rn ₂ [N]					ⓘ
				MC	MZ	HC/PC	HZ/PZ	FZ									
3.0	84000	1.1	487	315ML4	—	IEC200L4	BX200LA4	—	—	—	—	141900	170100	62300	392		
3.0	85100	2.0	493	317ML4	—	IEC200L4	BX200LA4	—	—	—	—	338400	359500	104200	414		
3.2	79100	0.9	458	314ML4	—	IEC200L4	BX200LA4	—	—	—	—	140600	168700	61000	380		
3.3	76100	1.2	441	315ML4	—	IEC200L4	BX200LA4	—	—	—	—	139900	167700	60200	392		
3.3	77200	1.6	447	316ML4	—	IEC200L4	BX200LA4	—	—	—	—	214500	240600	100900	404		
3.3	76400	1.6	443	—	316MR4	IEC200L4	BX200LA4	—	—	—	—	214200	240200	100500	406		
3.3	77500	2.4	449	317ML4	—	IEC200L4	BX200LA4	—	—	—	—	333900	354700	101000	414		
3.4	74300	1.4	430	—	316MR4	IEC200L4	BX200LA4	—	—	—	—	213300	239300	99600	406		
3.4	75600	2.1	438	—	317MR4	IEC200L4	BX200LA4	—	—	—	—	332700	353500	100200	416		
3.6	70600	1.3	409	—	315MR4	IEC200L4	BX200LA4	—	—	—	—	138400	166000	58800	394		
3.7	68000	1.1	394	314ML4	—	IEC200L4	BX200LA4	—	—	—	—	137600	165100	58000	380		
3.7	68900	1.5	399	316ML4	—	IEC200L4	BX200LA4	—	—	—	—	211000	236700	97100	404		
3.7	68900	2.2	399	—	317MR4	IEC200L4	BX200LA4	—	—	—	—	328300	348800	97100	416		
3.9	65300	2.8	378	317ML4	—	IEC200L4	BX200LA4	—	—	—	—	325800	346100	95400	414		
4.0	63800	1.5	370	315ML4	—	IEC200L4	BX200LA4	—	—	—	—	136400	163600	56800	392		
4.1	62600	1.6	363	—	316MR4	IEC200L4	BX200LA4	—	—	—	—	208100	233500	94100	406		
4.3	59500	1.6	345	—	315MR4	IEC200L4	BX200LA4	—	—	—	—	135000	161900	55500	394		
4.3	59700	1.7	346	316ML4	—	IEC200L4	BX200LA4	—	—	—	—	206700	231900	92600	404		
4.4	58200	1.7	337	—	316MR4	IEC200L4	BX200LA4	—	—	—	—	206000	231100	91800	406		
4.4	58000	2.2	336	—	317MR4	IEC200L4	BX200LA4	—	—	—	—	320400	340400	91700	416		
4.6	54900	2.3	318	316ML4	—	IEC200L4	BX200LA4	—	—	—	—	204300	229100	90000	404		
4.7	54200	1.4	314	314ML4	—	IEC200L4	BX200LA4	—	—	—	—	133200	159800	53800	380		
4.9	52200	1.8	302	315ML4	—	IEC200L4	BX200LA4	—	—	—	—	132500	158900	53100	392		
5.1	49900	2.2	289	—	316MR4	IEC200L4	BX200LA4	—	—	—	—	202000	226600	87200	406		
5.3	47500	2.6	275	316ML4	—	IEC200L4	BX200LA4	—	—	—	—	202000	226600	85800	404		
5.5	46400	2.0	269	—	315MR4	IEC200L4	BX200LA4	—	—	—	—	132000	158300	51100	394		
5.5	46400	2.2	269	—	316MR4	IEC200L4	BX200LA4	—	—	—	—	202000	226600	85100	406		
5.6	45200	2.2	262	—	317MR4	IEC200L4	BX200LA4	—	—	—	—	314300	333900	84400	416		
5.8	44900	1.0	252	313ML3	—	IEC200L4	BX200LA4	—	—	—	—	142000	166400	44500	368		
5.8	43700	2.8	253	316ML4	—	IEC200L4	BX200LA4	—	—	—	—	202000	226600	83500	404		
5.8	44900	2.5	252	317ML3	—	IEC200L4	BX200LA4	—	—	—	—	314300	333900	83400	414		
6.1	42600	1.1	240	314ML3	—	IEC200L4	BX200LA4	—	—	—	—	132000	158300	49200	380		
6.1	42800	1.4	241	315ML3	—	IEC200L4	BX200LA4	—	—	—	—	132000	158300	49200	392		
6.5	38900	2.2	225	—	315MR4	IEC200L4	BX200LA4	—	—	—	—	132000	158300	48200	394		
6.5	38900	2.2	225	—	316MR4	IEC200L4	BX200LA4	—	—	—	—	202000	226600	80300	406		
6.7	37900	2.2	220	—	317MR4	IEC200L4	BX200LA4	—	—	—	—	314300	333900	79600	416		
7.0	37100	1.1	209	313ML3	—	IEC200L4	BX200LA4	—	—	—	—	142000	166400	41700	368		
7.1	36700	1.7	206	314ML3	—	IEC200L4	BX200LA4	—	—	—	—	132000	158300	46700	380		
7.1	36800	2.1	207	315ML3	—	IEC200L4	BX200LA4	—	—	—	—	132000	158300	46800	392		
7.1	36800	2.7	207	316ML3	—	IEC200L4	BX200LA4	—	—	—	—	202000	226600	78000	404		
7.2	36100	1.0	203	311ML3	—	IEC200L4	BX200LA4	—	—	—	—	98000	100000	33600	356		
7.6	34500	1.4	194	313ML3	—	IEC200L4	BX200LA4	—	—	—	—	142000	166400	40700	368		
7.7	34000	0.9	191	311ML3	—	IEC200L4	BX200LA4	—	—	—	—	98000	100000	32900	356		
8.1	32400	0.9	182	313ML3	—	IEC200L4	BX200LA4	—	—	—	—	142000	166400	39900	368		
8.4	31300	1.3	176	313ML3	—	IEC200L4	BX200LA4	—	—	—	—	142000	166400	39400	368		
8.4	31000	2.4	174	315ML3	—	IEC200L4	BX200LA4	—	—	—	—	132000	158300	44200	392		
8.5	30900	2.0	174	314ML3	—	IEC200L4	BX200LA4	—	—	—	—	132000	158300	44200	380		
8.6	30400	1.2	171	311ML3	—	IEC200L4	BX200LA4	—	—	—	—	98000	100000	31700	356		
9.0	29100	0.9	164	310ML3	—	IEC200L4	BX200LA4	—	—	—	—	78000	98900	31300	344		
9.0	29000	1.8	163	313ML3	—	IEC200L4	BX200LA4	—	—	—	—	142000	166400	38400	368		
9.0	29200	2.0	164	314ML3	—	IEC200L4	BX200LA4	—	—	—	—	132000	158300	43300	380		
9.1	28700	1.2	161	311ML3	—	IEC200L4	BX200LA4	—	—	—	—	98000	100000	31100	356		
9.4	28000	1.7	157	—	314MR3C	IEC200L4	BX200LA4	—	—	—	—	132000	158300	42700	382		
9.4	28000	2.1	157	—	315MR3C	IEC200L4	BX200LA4	—	—	—	—	132000	158300	42700	394		
9.6	27200	1.1	153	—	313MR3	IEC200L4	BX200LA4	—	—	—	—	142000	166400	37600	370		
9.7	26900	1.5	151	313ML3	—	IEC200L4	BX200LA4	—	—	—	—	142000	166400	37500	368		
10.0	26200	1.3	147	311ML3	—	IEC200L4	BX200LA4	—	—	—	—	98000	100000	30200	356		
10.0	26100	1.0	147	—	311MR3	IEC200L4	BX200LA4	—	—	—	—	97900	100000	30100	358		

* The technical information shall be considered as indicative, the configurations should be matching the data provided by motors manufacturers on rated powers greater than 22 kW.



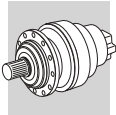

$P_1 = 30 \text{ kW}$

n_2 min ⁻¹	M_2 Nm	S	i	IE2*		IE3		IE2		IE3		Rn ₂ [N]					
				MC	MZ	HC/PC	HZ/PZ	FZ									
10.3	25400	1.6	143	313ML3	—	IEC200L4	BX200LA4	—	—	—	—	140800	165000	36800	368		
10.6	24600	2.8	138	314ML3	—	IEC200L4	BX200LA4	—	—	—	—	129600	155400	40900	380		
10.9	24100	1.1	135	310ML3	—	IEC200L4	BX200LA4	—	—	—	—	76100	96500	29300	344		
10.9	24000	2.1	135	313ML3	—	IEC200L4	BX200LA4	—	—	—	—	138400	162100	36100	368		
10.9	24100	2.5	135	—	314MR3C	IEC200L4	BX200LA4	—	—	—	—	128700	154400	40600	382		
11.0	23700	1.5	133	311ML3	—	IEC200L4	BX200LA4	—	—	—	—	95100	100000	29200	356		
11.6	22600	1.8	127	—	313MR3	IEC200L4	BX200LA4	—	—	—	—	135900	159300	35400	370		
11.9	22000	1.6	124	—	311MR3	IEC200L4	BX200LA4	—	—	—	—	93000	100000	28500	358		
12.2	21400	1.9	120	313ML3	—	IEC200L4	BX200LA4	—	—	—	—	133800	156800	34800	368		
12.4	21200	1.0	119	310ML3	—	IEC200L4	BX200LA4	—	—	—	—	73200	92800	28100	344		
12.8	20400	1.7	115	311ML3	—	IEC200L4	BX200LA4	—	—	—	—	90900	100000	27800	356		
12.9	20300	2.9	114	—	314MR3C	IEC200L4	BX200LA4	—	—	—	—	122300	146600	38400	382		
13.0	20200	2.3	113	—	314MR3B	IEC200L4	BX200LA4	—	—	—	—	122100	146500	38300	382		
13.0	20200	2.9	113	—	315MR3B	IEC200L4	BX200LA4	—	—	—	—	122100	146500	38300	394		
13.4	19500	2.3	110	313ML3	—	IEC200L4	BX200LA4	—	—	—	—	130100	152400	33700	368		
13.6	19200	1.3	108	310ML3	—	IEC200L4	BX200LA4	—	—	—	—	71100	90100	27200	344		
13.6	19200	2.9	108	314ML3	—	IEC200L4	BX200LA4	—	—	—	—	120300	144200	37700	380		
13.7	19100	2.0	107	—	313MR3	IEC200L4	BX200LA4	—	—	—	—	129100	151300	33400	370		
13.7	19200	2.9	108	—	314MR3C	IEC200L4	BX200LA4	—	—	—	—	120200	144200	37700	382		
14.1	18500	1.8	104	—	311MR3	IEC200L4	BX200LA4	—	—	—	—	88400	100000	26900	358		
14.2	18500	2.0	104	311ML3	—	IEC200L4	BX200LA4	—	—	—	—	88300	100000	26900	356		
14.6	17900	1.2	101	310ML3	—	IEC200L4	BX200LA4	—	—	—	—	69700	88300	26600	344		
15.1	17400	2.2	97.5	—	313MR3	IEC200L4	BX200LA4	—	—	—	—	125500	147100	32400	370		
15.3	17100	1.7	96.3	—	311MR3	IEC200L4	BX200LA4	—	—	—	—	86300	100000	26200	358		
15.9	16500	1.4	92.7	310ML3	—	IEC200L4	BX200LA4	—	—	—	—	67900	86100	25900	344		
15.9	16500	2.7	92.4	313ML3	—	IEC200L4	BX200LA4	—	—	—	—	123600	144800	31800	368		
16.5	15900	2.2	89.3	311ML3	—	IEC200L4	BX200LA4	—	—	—	—	84400	100000	25500	356		
17.9	14600	2.2	82.2	—	313MR3	IEC200L4	BX200LA4	—	—	—	—	119300	139800	30600	370		
18.1	14400	2.1	81.1	—	311MR3	IEC200L4	BX200LA4	—	—	—	—	82000	100000	24700	358		
18.3	14300	1.4	80.3	310ML3	—	IEC200L4	BX200LA4	—	—	—	—	65100	82500	24700	344		
19.0	13800	2.4	77.3	311ML3	—	IEC200L4	BX200LA4	—	—	—	—	80800	100000	24400	356		
19.9	13200	1.7	73.9	310ML3	—	IEC200L4	BX200LA4	—	—	—	—	63500	80500	24000	344		
20.7	12700	2.6	71.1	311ML3	—	IEC200L4	BX200LA4	—	—	—	—	78800	100000	23700	356		
21.0	12400	2.2	69.9	—	313MR3	IEC200L4	BX200LA4	—	—	—	—	113600	133200	29000	370		
21.6	12100	2.2	68.0	—	311MR3	IEC200L4	BX200LA4	—	—	—	—	77800	99200	23300	358		
23.0	11400	2.2	64.0	—	313MR3	IEC200L4	BX200LA4	—	—	—	—	110700	129700	28100	370		
23.3	11300	2.2	63.2	—	311MR3	IEC200L4	BX200LA4	—	—	—	—	76100	97000	22800	358		
23.5	11100	1.8	62.6	310ML3	—	IEC200L4	BX200LA4	—	—	—	—	60400	76600	22700	344		
24.4	10700	2.9	60.2	311ML3	—	IEC200L4	BX200LA4	—	—	—	—	75000	95700	22400	356		
27.4	9550	2.2	53.7	—	313MR3	IEC200L4	BX200LA4	—	—	—	—	105000	123000	26500	370		
27.7	9440	2.0	53.0	310ML3	—	IEC200L4	BX200LA4	—	—	—	—	57400	72800	21500	344		
27.7	9430	2.2	53.0	—	311MR3	IEC200L4	BX200LA4	—	—	—	—	72200	92000	21500	358		
31	8570	1.0	46.7	307L2	—	IEC200L4	BX200LA4	—	—	20500	25600	47900	63000	14300	320		
31	8570	1.5	46.7	309L2	—	IEC200L4	BX200LA4	—	—	—	—	48900	63000	11400	334		
31	8570	2.1	46.7	310ML2	—	IEC200L4	BX200LA4	—	—	—	—	55300	70100	20600	344		
38	7050	0.9	38.4	306L2	—	IEC200L4	BX200LA4	—	—	16000	18200	38100	44000	10400	308		
38	7090	1.2	38.6	307L2	—	IEC200L4	BX200LA4	—	—	19200	24000	45200	59500	13400	320		
38	7090	1.8	38.6	309L2	—	IEC200L4	BX200LA4	—	—	—	—	46200	59500	10700	334		
38	7090	2.5	38.6	310ML2	—	IEC200L4	BX200LA4	—	—	—	—	52200	66200	19300	344		
44	6070	1.1	33.1	306L2	—	IEC200L4	BX200LA4	—	—	15200	17300	36400	42100	9880	308		
45	5970	1.6	32.6	307L2	—	IEC200L4	BX200LA4	—	—	18100	22700	42900	56500	12600	320		
45	5970	2.2	32.6	309L2	—	IEC200L4	BX200LA4	—	—	—	—	43900	56500	10100	334		
48	5630	1.7	30.7	307L2	—	IEC200L4	BX200LA4	—	—	17800	22200	42200	55500	12400	320		
52	5220	1.3	28.4	306L2	—	IEC200L4	BX200LA4	—	—	14500	16500	34800	40200	9400	308		
53	5140	1.8	28.0	307L2	—	IEC200L4	BX200LA4	—	—	17300	21600	41000	54000	12000	320		
53	5140	2.5	28.0	309L2	—	IEC200L4	BX200LA4	—	—	—	—	42000	54000	9610	334		
56	4830	1.3	26.4	306L2	—	IEC200L4	BX200LA4	—	—	14100	16100	34000	39300	9160	308		
58	4650	2.0	25.4	307L2	—	IEC200L4	BX200LA4	—	—	16700	20900	39800	52400	11600	320		

* The technical information shall be considered as indicative, the configurations should be matching the data provided by motors manufacturers on rated powers greater than 22 kW.

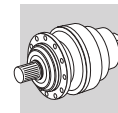

$P_1 = 30 \text{ kW}$

n_2 min ⁻¹	M_2 Nm	S	i	Motor Configurations		IEC Efficiency Classes				R_{n2} [N]					Icon
				309L2	307R2	IE2*	IE3	IE2	IE3	MC	MZ	HC/PC	HZ/PZ	FZ	
58	4650	2.3	25.4	309L2	—	IEC200L4	BX200LA4	—	—	—	—	40700	52400	9300	334
62	4320	1.9	23.5	—	307R2	IEC200L4	BX200LA4	—	—	16300	20400	39000	51300	11300	322
62	4320	2.2	23.5	—	309R2	IEC200L4	BX200LA4	—	—	—	—	39800	51300	9070	332
65	4160	1.5	22.7	306L2	—	IEC200L4	BX200LA4	—	—	13400	15300	32500	37600	8710	308
67	4000	2.2	21.8	307L2	—	IEC200L4	BX200LA4	—	—	15900	19900	38100	50100	11100	320
67	4000	2.5	21.8	309L2	—	IEC200L4	BX200LA4	—	—	—	—	38900	50100	8850	334
74	3640	2.2	19.8	—	307R2	IEC200L4	BX200LA4	—	—	15400	19200	37000	48700	10700	322
74	3640	2.2	19.8	—	309R2	IEC200L4	BX200LA4	—	—	—	—	37800	48700	8570	332
81	3310	1.8	18.1	306L2	—	IEC200L4	BX200LA4	—	—	12400	14200	30400	35100	8080	308
85	3190	2.6	17.4	307L2	—	IEC200L4	BX200LA4	—	—	14700	18400	35600	46800	10300	320
95	2840	2.2	15.5	—	307R2	IEC200L4	BX200LA4	—	—	14200	17700	34300	45200	9860	322
95	2840	2.2	15.5	—	309R2	IEC200L4	BX200LA4	—	—	—	—	35100	45200	7890	332
96	2810	1.8	15.3	306L2	—	IEC200L4	BX200LA4	—	—	11800	13400	28900	33400	7640	308
100	2700	2.9	14.7	307L2	—	IEC200L4	BX200LA4	—	—	13900	17400	33800	44500	9700	320
113	2380	2.0	13.0	306L2	—	IEC200L4	BX200LA4	—	—	11100	12700	27500	31800	7230	308
113	2380	2.2	13.0	—	307R2	IEC200L4	BX200LA4	—	—	13300	16700	32600	42800	9290	322
113	2380	2.2	13.0	—	309R2	IEC200L4	BX200LA4	—	—	—	—	33300	42800	7440	332
196	1420	1.6	7.50	305L1	—	IEC200L4	BX200LA4	—	—	7790	8900	16600	19700	4130	296
196	1420	2.9	7.50	306L1	—	IEC200L4	BX200LA4	—	—	9270	10600	23300	26900	6030	308
224	1240	1.5	6.57	304L1	—	IEC200L4	BX200LA4	—	—	7450	8520	15900	18900	3950	284
237	1170	1.2	6.20	303L1	—	IEC200L4	BX200LA4	—	—	7310	8350	15700	18600	3880	272
237	1170	2.3	6.20	305L1	—	IEC200L4	BX200LA4	—	—	7310	8350	15700	18600	3880	296
276	1010	1.5	5.33	303L1	—	IEC200L4	BX200LA4	—	—	6950	7950	15000	17700	3690	272
276	1010	2.0	5.33	304L1	—	IEC200L4	BX200LA4	—	—	6950	7950	15000	17700	3690	284
276	1010	2.6	5.33	305L1	—	IEC200L4	BX200LA4	—	—	6950	7950	15000	17700	3690	296
346	800	1.8	4.25	303L1	—	IEC200L4	BX200LA4	—	—	6450	7370	14000	16600	3420	272
346	800	2.4	4.25	304L1	—	IEC200L4	BX200LA4	—	—	6450	7370	14000	16600	3420	284
408	680	2.0	3.60	303L1	—	IEC200L4	BX200LA4	—	—	6100	6970	13300	15800	3230	272
408	680	2.7	3.60	304L1	—	IEC200L4	BX200LA4	—	—	6100	6970	13300	15800	3230	284

$P_1 = 37 \text{ kW}$

n_2 min ⁻¹	M_2 Nm	S	i	Motor Configurations		IEC Efficiency Classes				R_{n2} [N]					Icon
				319L4	319R4C	IE2*	IE3	IE2	IE3	MC	MZ	HC/PC	HZ/PZ	FZ	
1.1	293800	1.1	1389	319L4	—	IEC225S4	BX225SA4	—	—	—	—	453100	498800	195800	434
1.2	252700	1.4	1195	319L4	—	IEC225S4	BX225SA4	—	—	—	—	443400	488200	186200	434
1.3	237300	2.2	1122	321L4	—	IEC225S4	BX225SA4	—	—	—	—	621600	739900	1104200	444
1.4	224100	1.2	1059	318ML4	—	IEC225S4	BX225SA4	—	—	—	—	358700	405000	178900	424
1.5	213000	1.6	1007	319L4	—	IEC225S4	BX225SA4	—	—	—	—	432700	476400	175900	434
1.6	192800	1.4	911	318ML4	—	IEC225S4	BX225SA4	—	—	—	—	351100	396400	170100	424
1.6	192900	1.7	912	319L4	—	IEC225S4	BX225SA4	—	—	—	—	426600	469700	170200	434
1.6	191800	1.7	906	—	319R4C	IEC225S4	BX225SA4	—	—	—	—	426300	469300	169800	436
1.6	199900	2.9	945	321L4	—	IEC225S4	BX225SA4	—	—	—	—	606600	722000	1048900	444
1.7	180000	2.2	850	319L4	—	IEC225S4	BX225SA4	—	—	—	—	422400	465100	166300	434
1.8	169700	1.9	802	319L4	—	IEC225S4	BX225SA4	—	—	—	—	418900	461200	163100	434
1.9	162400	1.7	768	318ML4	—	IEC225S4	BX225SA4	—	—	—	—	342600	386800	160700	424
1.9	165000	1.9	780	—	319R4C	IEC225S4	BX225SA4	—	—	—	—	417200	459400	161500	436
2.0	153600	1.7	726	318ML4	—	IEC225S4	BX225SA4	—	—	—	—	339900	383800	157700	424
2.1	146300	1.8	691	—	318MR4C	IEC225S4	BX225SA4	—	—	—	—	337500	381100	155200	426
2.1	151600	2.6	717	319L4	—	IEC225S4	BX225SA4	—	—	—	—	412200	453900	157100	434
2.2	143400	2.7	678	319L4	—	IEC225S4	BX225SA4	—	—	—	—	408900	450300	154200	434
2.3	136900	1.9	647	318ML4	—	IEC225S4	BX225SA4	—	—	—	—	334300	377500	151800	424
2.3	138500	2.2	655	—	319R4B	IEC225S4	BX225SA4	—	—	—	—	406900	448000	152400	436

* The technical information shall be considered as indicative, the configurations should be matching the data provided by motors manufacturers on rated powers greater than 22 kW.



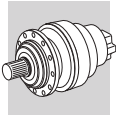

$P_1 = 37 \text{ kW}$

n_2 min ⁻¹	M_2 Nm	S	i	IE2*		IE3		IE2		IE3		R _{n2} [N]					
				MC	MZ	HC/PC	HZ/PZ	FZ									
2.3	139000	2.2	657	—	319R4C	IEC225S4	BX225SA4	—	—	—	—	407100	448300	152600	436		
2.4	129400	2.0	612	318ML4	—	IEC225S4	BX225SA4	—	—	—	—	331700	374500	149000	424		
2.4	132200	2.3	625	319L4	—	IEC225S4	BX225SA4	—	—	—	—	404200	445100	150000	434		
2.5	125800	2.1	595	—	318MR4C	IEC225S4	BX225SA4	—	—	—	—	330300	373000	147600	426		
2.6	119200	2.5	563	—	319R4B	IEC225S4	BX225SA4	—	—	—	—	398300	438500	144900	436		
2.9	109100	2.3	515	318ML4	—	IEC225S4	BX225SA4	—	—	—	—	323700	365400	140700	424		
2.9	109000	2.7	515	319L4	—	IEC225S4	BX225SA4	—	—	—	—	393200	432900	140700	434		
3.0	105600	2.4	499	—	318MR4B	IEC225S4	BX225SA4	—	—	—	—	322200	363800	139200	426		
3.0	106000	2.4	501	—	318MR4C	IEC225S4	BX225SA4	—	—	—	—	322300	364000	139400	426		
3.1	100900	2.5	477	318ML4	—	IEC225S4	BX225SA4	—	—	—	—	320100	361400	137100	424		
3.1	100300	2.5	474	—	318MR4C	IEC225S4	BX225SA4	—	—	—	—	319800	361100	136800	426		
3.1	100400	2.9	475	—	319R4B	IEC225S4	BX225SA4	—	—	—	—	388600	427900	136900	436		
3.4	90900	2.7	430	—	318MR4B	IEC225S4	BX225SA4	—	—	—	—	315300	356000	132400	426		
3.5	89400	2.8	422	318ML4	—	IEC225S4	BX225SA4	—	—	—	—	314600	355200	131700	424		
3.7	85000	2.9	402	318ML4	—	IEC225S4	BX225SA4	—	—	—	—	312300	352600	129500	424		
3.7	84500	2.9	399	—	318MR4C	IEC225S4	BX225SA4	—	—	—	—	312100	352300	129200	426		
5.9	55000	2.1	252	317ML3	—	IEC225S4	BX225SA4	—	—	—	—	314300	333900	83200	414		
6.1	52500	1.1	241	315ML3	—	IEC225S4	BX225SA4	—	—	—	—	132000	158300	49100	392		
6.2	52200	0.9	240	314ML3	—	IEC225S4	BX225SA4	—	—	—	—	132000	158300	49000	380		
7.1	45200	1.7	207	315ML3	—	IEC225S4	BX225SA4	—	—	—	—	132000	158300	46700	392		
7.1	45200	2.2	207	316ML3	—	IEC225S4	BX225SA4	—	—	—	—	202000	226600	77900	404		
7.2	44900	1.4	206	314ML3	—	IEC225S4	BX225SA4	—	—	—	—	132000	158300	46600	380		
8.5	37900	1.6	174	314ML3	—	IEC225S4	BX225SA4	—	—	—	—	132000	158300	44100	380		
8.5	38100	2.0	174	315ML3	—	IEC225S4	BX225SA4	—	—	—	—	132000	158300	44100	392		
8.5	38100	2.6	174	316ML3	—	IEC225S4	BX225SA4	—	—	—	—	202000	226600	73500	404		
9.0	35800	1.7	164	314ML3	—	IEC225S4	BX225SA4	—	—	—	—	132000	158300	43200	380		
9.0	36000	2.5	165	315ML3	—	IEC225S4	BX225SA4	—	—	—	—	132000	158300	43300	392		
9.4	34300	1.4	157	—	314MR3C	IEC225S4	BX225SA4	—	—	—	—	132000	158300	42600	382		
9.4	34300	1.7	157	—	315MR3C	IEC225S4	BX225SA4	—	—	—	—	132000	158300	42600	394		
10.6	30300	2.9	139	315ML3	—	IEC225S4	BX225SA4	—	—	—	—	129500	155400	40900	392		
10.7	30200	2.3	138	314ML3	—	IEC225S4	BX225SA4	—	—	—	—	129400	155100	40800	380		
11.0	29500	2.0	135	—	314MR3C	IEC225S4	BX225SA4	—	—	—	—	128400	154000	40500	382		
11.0	29500	2.5	135	—	315MR3C	IEC225S4	BX225SA4	—	—	—	—	128400	154000	40500	394		
13.0	24800	1.9	113	—	314MR3B	IEC225S4	BX225SA4	—	—	—	—	121900	146200	38200	382		
13.0	24800	2.3	114	—	314MR3C	IEC225S4	BX225SA4	—	—	—	—	122000	146300	38300	382		
13.0	24800	2.4	113	—	315MR3B	IEC225S4	BX225SA4	—	—	—	—	121900	146200	38200	394		
13.0	24800	2.9	114	—	315MR3C	IEC225S4	BX225SA4	—	—	—	—	122000	146300	38300	394		
13.7	23500	2.3	108	314ML3	—	IEC225S4	BX225SA4	—	—	—	—	120000	143900	37600	380		
13.7	23500	2.4	108	—	314MR3C	IEC225S4	BX225SA4	—	—	—	—	120000	143900	37600	382		
15.2	21300	2.7	97.6	—	314MR3B	IEC225S4	BX225SA4	—	—	—	—	116500	139700	36400	382		
16.0	20200	2.6	92.7	314ML3	—	IEC225S4	BX225SA4	—	—	—	—	114700	137600	35700	380		
32	10500	1.7	46.7	310ML2	—	IEC225S4	BX225SA4	—	—	—	—	55200	70000	20500	344		
38	8690	2.1	38.6	310ML2	—	IEC225S4	BX225SA4	—	—	—	—	52100	66100	19300	344		
45	7320	2.8	32.6	310ML2	—	IEC225S4	BX225SA4	—	—	—	—	49500	62800	18200	344		
48	6900	2.5	30.7	310ML2	—	IEC225S4	BX225SA4	—	—	—	—	48600	61700	17900	344		
58	5700	2.9	25.4	310ML2	—	IEC225S4	BX225SA4	—	—	—	—	45900	58300	16800	344		
197	1740	2.4	7.50	306L1	—	IEC225S4	BX225SA4	—	—	9250	10500	23300	26900	6010	308		
239	1440	2.9	6.20	306L1	—	IEC225S4	BX225SA4	—	—	8680	9900	22000	25400	5640	308		

* The technical information shall be considered as indicative, the configurations should be matching the data provided by motors manufacturers on rated powers greater than 22 kW.

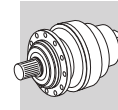

$P_1 = 45 \text{ kW}$

n ₂ min ⁻¹	M ₂ Nm	S	i	Motor Configurations		IEC Efficiency Classes				Rn ₂ [N]					Icon
				IE2*	IE3	IE2	IE3	MC	MZ	HC/PC	HZ/PZ	FZ			
1.1	356500	0.9	1389	319L4	—	IEC225M4	BX225SB4	—	—	—	—	453100	498800	195800	434
1.2	306700	1.1	1195	319L4	—	IEC225M4	BX225SB4	—	—	—	—	443400	488200	186200	434
1.2	328500	2.7	1279	323L4	—	IEC225M4	BX225SB4	—	—	—	—	0	0	1053000	454
1.2	328500	2.9	1279	325L4	—	IEC225M4	BX225SB4	—	—	—	—	0	0	1340200	458
1.3	287900	1.8	1122	321L4	—	IEC225M4	BX225SB4	—	—	—	—	621600	739900	1104200	444
1.4	271900	1.0	1059	318ML4	—	IEC225M4	BX225SB4	—	—	—	—	358700	405000	178900	424
1.5	258400	1.3	1007	319L4	—	IEC225M4	BX225SB4	—	—	—	—	432700	476400	175900	434
1.6	233900	1.2	911	318ML4	—	IEC225M4	BX225SB4	—	—	—	—	351100	396400	170100	424
1.6	234100	1.4	912	319L4	—	IEC225M4	BX225SB4	—	—	—	—	426600	469700	170200	434
1.6	232700	1.4	906	—	319R4C	IEC225M4	BX225SB4	—	—	—	—	426300	469300	169800	436
1.6	242600	2.4	945	321L4	—	IEC225M4	BX225SB4	—	—	—	—	606600	722000	1048900	444
1.7	218400	1.9	850	319L4	—	IEC225M4	BX225SB4	—	—	—	—	422400	465100	166300	434
1.8	205900	1.6	802	319L4	—	IEC225M4	BX225SB4	—	—	—	—	418900	461200	163100	434
1.9	197100	1.4	768	318ML4	—	IEC225M4	BX225SB4	—	—	—	—	342600	386800	160700	424
1.9	200200	1.6	780	—	319R4C	IEC225M4	BX225SB4	—	—	—	—	417200	459400	161500	436
1.9	204400	2.7	796	321L4	—	IEC225M4	BX225SB4	—	—	—	—	591900	704600	996400	444
2.0	186400	1.4	726	318ML4	—	IEC225M4	BX225SB4	—	—	—	—	339900	383800	157700	424
2.0	189100	2.9	736	321L4	—	IEC225M4	BX225SB4	—	—	—	—	585400	696800	973300	444
2.0	187900	2.8	732	—	321R4C	IEC225M4	BX225SB4	—	—	—	—	584900	696200	971500	446
2.1	177500	1.5	691	—	318MR4C	IEC225M4	BX225SB4	—	—	—	—	337500	381100	155200	426
2.1	184000	2.2	717	319L4	—	IEC225M4	BX225SB4	—	—	—	—	412200	453900	157100	434
2.2	174000	2.2	678	319L4	—	IEC225M4	BX225SB4	—	—	—	—	408900	450300	154200	434
2.3	166100	1.6	647	318ML4	—	IEC225M4	BX225SB4	—	—	—	—	334300	377500	151800	424
2.3	168100	1.8	655	—	319R4B	IEC225M4	BX225SB4	—	—	—	—	406900	448000	152400	436
2.3	168700	1.8	657	—	319R4C	IEC225M4	BX225SB4	—	—	—	—	407100	448300	152600	436
2.4	157000	1.7	612	318ML4	—	IEC225M4	BX225SB4	—	—	—	—	331700	374500	149000	424
2.4	160500	1.9	625	319L4	—	IEC225M4	BX225SB4	—	—	—	—	404200	445100	150000	434
2.5	152700	1.7	595	—	318MR4C	IEC225M4	BX225SB4	—	—	—	—	330300	373000	147600	426
2.6	146600	2.6	571	319L4	—	IEC225M4	BX225SB4	—	—	—	—	399100	439400	145600	434
2.6	144600	2.1	563	—	319R4B	IEC225M4	BX225SB4	—	—	—	—	398300	438500	144900	436
2.7	143400	2.6	558	319L4	—	IEC225M4	BX225SB4	—	—	—	—	397800	438000	144500	434
2.7	142500	2.6	555	—	319R4C	IEC225M4	BX225SB4	—	—	—	—	397400	437600	144200	436
2.8	135600	2.7	528	319L4	—	IEC225M4	BX225SB4	—	—	—	—	394600	434500	141900	434
2.8	134800	2.7	525	—	319R4C	IEC225M4	BX225SB4	—	—	—	—	394300	434100	141600	436
2.9	132300	1.9	515	318ML4	—	IEC225M4	BX225SB4	—	—	—	—	323700	365400	140700	424
2.9	132200	2.3	515	319L4	—	IEC225M4	BX225SB4	—	—	—	—	393200	432900	140700	434
3.0	128200	1.9	499	—	318MR4B	IEC225M4	BX225SB4	—	—	—	—	322200	363800	139200	426
3.0	128600	2.0	501	—	318MR4C	IEC225M4	BX225SB4	—	—	—	—	322300	364000	139400	426
3.1	122400	2.1	477	318ML4	—	IEC225M4	BX225SB4	—	—	—	—	320100	361400	137100	424
3.1	121600	2.1	474	—	318MR4C	IEC225M4	BX225SB4	—	—	—	—	319800	361100	136800	426
3.1	121800	2.4	475	—	319R4B	IEC225M4	BX225SB4	—	—	—	—	388600	427900	136900	436
3.4	110300	2.2	430	—	318MR4B	IEC225M4	BX225SB4	—	—	—	—	315300	356000	132400	426
3.5	108400	2.3	422	318ML4	—	IEC225M4	BX225SB4	—	—	—	—	314600	355200	131700	424
3.6	105300	2.7	410	319L4	—	IEC225M4	BX225SB4	—	—	—	—	380700	419100	130400	434
3.7	103100	2.4	402	318ML4	—	IEC225M4	BX225SB4	—	—	—	—	312300	352600	129500	424
3.7	102500	2.4	399	—	318MR4C	IEC225M4	BX225SB4	—	—	—	—	312100	352300	129200	426
4.1	92900	2.6	362	—	318MR4B	IEC225M4	BX225SB4	—	—	—	—	307700	347400	125100	426
4.3	87900	2.7	342	—	318MR4B	IEC225M4	BX225SB4	—	—	—	—	305300	344700	122800	426
4.4	86400	2.7	337	318ML4	—	IEC225M4	BX225SB4	—	—	—	—	304500	343900	122100	424
4.7	80300	2.9	313	318ML4	—	IEC225M4	BX225SB4	—	—	—	—	301400	340300	119200	424
4.8	79900	2.9	311	—	318MR4C	IEC225M4	BX225SB4	—	—	—	—	301100	340000	118900	426
5.9	66800	1.7	252	317ML3	—	IEC225M4	BX225SB4	—	—	—	—	314300	333900	83200	414

A

* The technical information shall be considered as indicative, the configurations should be matching the data provided by motors manufacturers on rated powers greater than 22 kW.

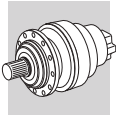

$P_1 = 45 \text{ kW}$

n_2 min ⁻¹	M_2 Nm	S	i	IE2*		IE3		IE2		IE3		R _{n2} [N]					
				IE2*	IE3	IE2	IE3	MC	MZ	HC/PC	HZ/PZ	FZ					
6.1	63700	0.9	241	315ML3	—	IEC225M4	BX225SB4	—	—	—	—	132000	158300	49100	392		
7.0	56300	2.6	213	317ML3	—	IEC225M4	BX225SB4	—	—	—	—	314300	333900	78600	414		
7.1	54800	1.4	207	315ML3	—	IEC225M4	BX225SB4	—	—	—	—	132000	158300	46700	392		
7.1	54800	1.8	207	316ML3	—	IEC225M4	BX225SB4	—	—	—	—	202000	226600	77900	404		
7.2	54500	1.1	206	314ML3	—	IEC225M4	BX225SB4	—	—	—	—	132000	158300	46600	380		
8.5	45900	1.3	174	314ML3	—	IEC225M4	BX225SB4	—	—	—	—	132000	158300	44100	380		
8.5	46200	1.6	174	315ML3	—	IEC225M4	BX225SB4	—	—	—	—	132000	158300	44100	392		
8.5	46200	2.2	174	316ML3	—	IEC225M4	BX225SB4	—	—	—	—	202000	226600	73500	404		
8.9	43900	2.8	166	317ML3	—	IEC225M4	BX225SB4	—	—	—	—	314300	333900	72300	414		
9.0	43500	1.4	164	314ML3	—	IEC225M4	BX225SB4	—	—	—	—	132000	158300	43200	380		
9.0	43700	2.1	165	315ML3	—	IEC225M4	BX225SB4	—	—	—	—	132000	158300	43300	392		
9.0	43700	2.6	165	316ML3	—	IEC225M4	BX225SB4	—	—	—	—	202000	226600	72200	404		
9.0	43600	2.6	165	—	317MR3C	IEC225M4	BX225SB4	—	—	—	—	314300	333900	72100	416		
9.4	41600	1.1	157	—	314MR3C	IEC225M4	BX225SB4	—	—	—	—	132000	158300	42600	382		
9.4	41600	1.4	157	—	315MR3C	IEC225M4	BX225SB4	—	—	—	—	132000	158300	42600	394		
10.6	36800	2.4	139	315ML3	—	IEC225M4	BX225SB4	—	—	—	—	129500	155400	40900	392		
10.7	36600	1.9	138	314ML3	—	IEC225M4	BX225SB4	—	—	—	—	129400	155100	40800	380		
11.0	35800	1.7	135	—	314MR3C	IEC225M4	BX225SB4	—	—	—	—	128400	154000	40500	382		
11.0	35800	2.1	135	—	315MR3C	IEC225M4	BX225SB4	—	—	—	—	128400	154000	40500	394		
11.0	35800	2.7	135	—	316MR3C	IEC225M4	BX225SB4	—	—	—	—	196600	220500	67500	406		
13.0	30000	1.6	113	—	314MR3B	IEC225M4	BX225SB4	—	—	—	—	121900	146200	38200	382		
13.0	30100	1.9	114	—	314MR3C	IEC225M4	BX225SB4	—	—	—	—	122000	146300	38300	382		
13.0	30000	2.0	113	—	315MR3B	IEC225M4	BX225SB4	—	—	—	—	121900	146200	38200	394		
13.0	30100	2.4	114	—	315MR3C	IEC225M4	BX225SB4	—	—	—	—	122000	146300	38300	394		
13.7	28500	1.9	108	314ML3	—	IEC225M4	BX225SB4	—	—	—	—	120000	143900	37600	380		
13.7	28500	2.0	108	—	314MR3C	IEC225M4	BX225SB4	—	—	—	—	120000	143900	37600	382		
13.7	28700	2.9	108	315ML3	—	IEC225M4	BX225SB4	—	—	—	—	120200	144200	37600	392		
13.7	28500	2.9	108	—	315MR3C	IEC225M4	BX225SB4	—	—	—	—	120000	143900	37600	394		
15.2	25800	2.2	97.6	—	314MR3B	IEC225M4	BX225SB4	—	—	—	—	116500	139700	36400	382		
15.2	25800	2.8	97.6	—	315MR3B	IEC225M4	BX225SB4	—	—	—	—	116500	139700	36400	394		
16.0	24500	2.2	92.7	314ML3	—	IEC225M4	BX225SB4	—	—	—	—	114700	137600	35700	380		
16.3	24000	2.6	90.7	—	314MR3C	IEC225M4	BX225SB4	—	—	—	—	114000	136700	35500	382		
18.0	21800	2.5	82.3	—	314MR3B	IEC225M4	BX225SB4	—	—	—	—	110700	132700	34300	382		
19.0	20600	2.6	77.8	—	314MR3B	IEC225M4	BX225SB4	—	—	—	—	108800	130500	33700	382		
20.0	19600	2.6	73.9	314ML3	—	IEC225M4	BX225SB4	—	—	—	—	107200	128500	33100	380		
20.9	18700	2.6	70.7	—	314MR3C	IEC225M4	BX225SB4	—	—	—	—	105800	126800	32700	382		
22.6	17300	2.9	65.5	—	314MR3B	IEC225M4	BX225SB4	—	—	—	—	103400	124000	31800	382		
23.6	16600	3.0	62.6	314ML3	—	IEC225M4	BX225SB4	—	—	—	—	102000	122300	31400	380		
29.0	13500	2.9	51.1	—	314MR3B	IEC225M4	BX225SB4	—	—	—	—	95900	115000	29300	382		
32	12800	1.4	46.7	310ML2	—	IEC225M4	BX225SB4	—	—	—	—	55200	70000	20500	344		
37	11100	2.7	40.5	313ML2	—	IEC225M4	BX225SB4	—	—	—	—	96300	112800	24100	368		
38	10500	1.7	38.6	310ML2	—	IEC225M4	BX225SB4	—	—	—	—	52100	66100	19300	344		
38	10600	2.6	38.8	311ML2	—	IEC225M4	BX225SB4	—	—	—	—	65600	83700	19300	356		
45	8880	2.3	32.6	310ML2	—	IEC225M4	BX225SB4	—	—	—	—	49500	62800	18200	344		
48	8370	2.1	30.7	310ML2	—	IEC225M4	BX225SB4	—	—	—	—	48600	61700	17900	344		
53	7640	2.7	28.0	310ML2	—	IEC225M4	BX225SB4	—	—	—	—	47300	60000	17300	344		
58	6920	2.4	25.4	310ML2	—	IEC225M4	BX225SB4	—	—	—	—	45900	58300	16800	344		
58	6910	2.5	25.3	—	310MR2C	IEC225M4	BX225SB4	—	—	—	—	45900	58200	16800	346		
68	5950	2.7	21.8	310ML2	—	IEC225M4	BX225SB4	—	—	—	—	43900	55700	15900	344		
197	2110	1.9	7.50	306L1	—	IEC225M4	BX225SB4	—	—	9250	10500	23300	26900	6010	308		
239	1740	2.4	6.20	306L1	—	IEC225M4	BX225SB4	—	—	8680	9900	22000	25400	5640	308		
278	1500	2.7	5.33	306L1	—	IEC225M4	BX225SB4	—	—	8260	9410	21000	24300	5370	308		

* The technical information shall be considered as indicative, the configurations should be matching the data provided by motors manufacturers on rated powers greater than 22 kW.

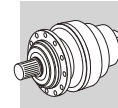

$P_1 = 55 \text{ kW}$

n ₂ min ⁻¹	M ₂ Nm	S	i	Motor Type		IEC Efficiency Class				Rn ₂ [N]					Icon
				IE2*	IE3	IE2	IE3	MC	MZ	HC/PC	HZ/PZ	FZ			
1.2	375400	0.9	1195	319L4	—	IEC250M4	BX250MA4	—	—	—	—	443400	488200	186200	434
1.2	402100	2.2	1279	323L4	—	IEC250M4	BX250MA4	—	—	—	—	—	—	1053000	454
1.2	402100	2.4	1279	325L4	—	IEC250M4	BX250MA4	—	—	—	—	—	—	1340200	458
1.3	352500	1.5	1122	321L4	—	IEC250M4	BX250MA4	—	—	—	—	621600	739900	1104200	444
1.3	345900	2.5	1101	323L4	—	IEC250M4	BX250MA4	—	—	—	—	—	—	1006500	454
1.3	345900	2.8	1101	325L4	—	IEC250M4	BX250MA4	—	—	—	—	—	—	1281000	458
1.4	322200	2.7	1025	323L4	—	IEC250M4	BX250MA4	—	—	—	—	—	—	985300	454
1.5	316300	1.1	1007	319L4	—	IEC250M4	BX250MA4	—	—	—	—	432700	476400	175900	434
1.6	286300	1.0	911	318ML4	—	IEC250M4	BX250MA4	—	—	—	—	351100	396400	170100	424
1.6	286500	1.1	912	319L4	—	IEC250M4	BX250MA4	—	—	—	—	426600	469700	170200	434
1.6	284800	1.1	906	—	319R4C	IEC250M4	BX250MA4	—	—	—	—	426300	469300	169800	436
1.6	297000	2.0	945	321L4	—	IEC250M4	BX250MA4	—	—	—	—	606600	722000	1048900	444
1.7	267300	1.5	850	319L4	—	IEC250M4	BX250MA4	—	—	—	—	422400	465100	166300	434
1.8	252100	1.3	802	319L4	—	IEC250M4	BX250MA4	—	—	—	—	418900	461200	163100	434
1.9	241300	1.1	768	318ML4	—	IEC250M4	BX250MA4	—	—	—	—	342600	386800	160700	424
1.9	245000	1.3	780	—	319R4C	IEC250M4	BX250MA4	—	—	—	—	417200	459400	161500	436
1.9	250200	2.2	796	321L4	—	IEC250M4	BX250MA4	—	—	—	—	591900	704600	996400	444
2.0	228200	1.2	726	318ML4	—	IEC250M4	BX250MA4	—	—	—	—	339900	383800	157700	424
2.0	231400	2.4	736	321L4	—	IEC250M4	BX250MA4	—	—	—	—	585400	696800	973300	444
2.0	230100	2.3	732	—	321R4C	IEC250M4	BX250MA4	—	—	—	—	584900	696200	971500	446
2.1	217200	1.2	691	—	318MR4C	IEC250M4	BX250MA4	—	—	—	—	337500	381100	155200	426
2.1	225200	1.8	717	319L4	—	IEC250M4	BX250MA4	—	—	—	—	412200	453900	157100	434
2.2	213000	1.8	678	319L4	—	IEC250M4	BX250MA4	—	—	—	—	408900	450300	154200	434
2.3	203300	1.3	647	318ML4	—	IEC250M4	BX250MA4	—	—	—	—	334300	377500	151800	424
2.3	205800	1.5	655	—	319R4B	IEC250M4	BX250MA4	—	—	—	—	406900	448000	152400	436
2.3	206500	1.5	657	—	319R4C	IEC250M4	BX250MA4	—	—	—	—	407100	448300	152600	436
2.4	192200	1.4	612	318ML4	—	IEC250M4	BX250MA4	—	—	—	—	331700	374500	149000	424
2.4	196400	1.6	625	319L4	—	IEC250M4	BX250MA4	—	—	—	—	404200	445100	150000	434
2.4	192300	2.7	612	321L4	—	IEC250M4	BX250MA4	—	—	—	—	570100	678500	920600	444
2.4	193800	2.6	617	—	321R4C	IEC250M4	BX250MA4	—	—	—	—	570700	679300	922900	446
2.5	186900	1.4	595	—	318MR4C	IEC250M4	BX250MA4	—	—	—	—	330300	373000	147600	426
2.6	179500	2.1	571	319L4	—	IEC250M4	BX250MA4	—	—	—	—	399100	439400	145600	434
2.6	177000	1.7	563	—	319R4B	IEC250M4	BX250MA4	—	—	—	—	398300	438500	144900	436
2.7	175500	2.1	558	319L4	—	IEC250M4	BX250MA4	—	—	—	—	397800	438000	144500	434
2.7	174500	2.2	555	—	319R4C	IEC250M4	BX250MA4	—	—	—	—	397400	437600	144200	436
2.8	166000	2.2	528	319L4	—	IEC250M4	BX250MA4	—	—	—	—	394600	434500	141900	434
2.8	165000	2.2	525	—	319R4C	IEC250M4	BX250MA4	—	—	—	—	394300	434100	141600	436
2.8	166200	2.9	529	—	321R4B	IEC250M4	BX250MA4	—	—	—	—	558300	664600	881200	446
2.9	162000	1.6	515	318ML4	—	IEC250M4	BX250MA4	—	—	—	—	323700	365400	140700	424
2.9	161800	1.8	515	319L4	—	IEC250M4	BX250MA4	—	—	—	—	393200	432900	140700	434
2.9	161000	2.6	512	—	321R4C	IEC250M4	BX250MA4	—	—	—	—	555800	661600	872900	446
3.0	156900	1.6	499	—	318MR4B	IEC250M4	BX250MA4	—	—	—	—	322200	363800	139200	426
3.0	157500	1.6	501	—	318MR4C	IEC250M4	BX250MA4	—	—	—	—	322300	364000	139400	426
3.1	149800	1.7	477	318ML4	—	IEC250M4	BX250MA4	—	—	—	—	320100	361400	137100	424
3.1	148900	1.7	474	—	318MR4C	IEC250M4	BX250MA4	—	—	—	—	319800	361100	136800	426
3.1	149100	2.0	475	—	319R4B	IEC250M4	BX250MA4	—	—	—	—	388600	427900	136900	436
3.1	151000	2.6	481	—	321R4C	IEC250M4	BX250MA4	—	—	—	—	550700	655600	856300	446
3.3	139800	2.5	445	319L4	—	IEC250M4	BX250MA4	—	—	—	—	385100	424000	134000	434
3.3	139000	2.5	442	—	319R4C	IEC250M4	BX250MA4	—	—	—	—	384800	423600	133700	436
3.3	140000	2.9	446	—	321R4B	IEC250M4	BX250MA4	—	—	—	—	544800	648500	837100	446
3.4	135000	1.8	430	—	318MR4B	IEC250M4	BX250MA4	—	—	—	—	315300	356000	132400	426
3.5	132800	1.9	422	318ML4	—	IEC250M4	BX250MA4	—	—	—	—	314600	355200	131700	424
3.6	129000	2.2	410	319L4	—	IEC250M4	BX250MA4	—	—	—	—	380700	419100	130400	434
3.7	126200	1.9	402	318ML4	—	IEC250M4	BX250MA4	—	—	—	—	312300	352600	129500	424
3.7	125500	1.9	399	—	318MR4C	IEC250M4	BX250MA4	—	—	—	—	312100	352300	129200	426
3.7	126000	2.7	401	—	319R4B	IEC250M4	BX250MA4	—	—	—	—	379400	417700	129400	436
3.7	125500	2.6	399	—	321R4C	IEC250M4	BX250MA4	—	—	—	—	536300	638400	810000	446
3.9	119200	2.8	379	—	319R4B	IEC250M4	BX250MA4	—	—	—	—	376400	414400	127000	436
4.0	116300	2.9	370	—	321R4B	IEC250M4	BX250MA4	—	—	—	—	530600	631500	791800	446
4.1	113700	2.1	362	—	318MR4B	IEC250M4	BX250MA4	—	—	—	—	307700	347400	125100	426
4.3	107600	2.2	342	—	318MR4B	IEC250M4	BX250MA4	—	—	—	—	305300	344700	122800	426

* The technical information shall be considered as indicative, the configurations should be matching the data provided by motors manufacturers on rated powers greater than 22 kW.



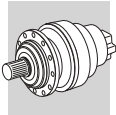

$P_1 = 55 \text{ kW}$

n_2 min ⁻¹	M_2 Nm	S	i	Motor		IE2*		IE3		R_{n2} [N]					Icon
				318ML4	318ML4	IE2	IE3	IE2	IE3	MC	MZ	HC/PC	HZ/PZ	FZ	
4.3	108300	2.7	345	—	319R4C	IEC250M4	BX250MA4	—	—	—	—	371300	408800	123100	436
4.3	109100	3.0	347	—	321R4B	IEC250M4	BX250MA4	—	—	—	—	525700	625800	776700	446
4.4	105800	2.2	337	318ML4	—	IEC250M4	BX250MA4	—	—	—	—	304500	343900	122100	424
4.6	100400	3.0	320	—	319R4B	IEC250M4	BX250MA4	—	—	—	—	367300	404400	120000	436
4.7	98400	2.4	313	318ML4	—	IEC250M4	BX250MA4	—	—	—	—	301400	340300	119200	424
4.8	97800	2.4	311	—	318MR4C	IEC250M4	BX250MA4	—	—	—	—	301100	340000	118900	426
4.8	96300	2.6	306	—	321R4C	IEC250M4	BX250MA4	—	—	—	—	516400	614700	748100	446
5.1	90600	2.6	288	—	318MR4B	IEC250M4	BX250MA4	—	—	—	—	299000	337600	115900	426
5.1	90600	2.9	288	—	321R4B	IEC250M4	BX250MA4	—	—	—	—	513900	611700	734700	446
5.6	82400	2.8	262	318ML4	—	IEC250M4	BX250MA4	—	—	—	—	299000	337600	112300	424
5.9	81800	1.4	252	317ML3	—	IEC250M4	BX250MA4	—	—	—	—	314300	333900	83200	414
5.9	78200	3.0	249	—	319R4B	IEC250M4	BX250MA4	—	—	—	—	363300	400000	110400	436
6.6	70600	3.0	225	—	318MR4B	IEC250M4	BX250MA4	—	—	—	—	299000	337600	106700	426
6.7	69500	3.0	221	—	321R4B	IEC250M4	BX250MA4	—	—	—	—	513900	611700	678500	446
7.0	68900	2.1	213	317ML3	—	IEC250M4	BX250MA4	—	—	—	—	314300	333900	78600	414
7.1	67100	1.1	207	315ML3	—	IEC250M4	BX250MA4	—	—	—	—	132000	158300	46700	392
7.1	67100	1.5	207	316ML3	—	IEC250M4	BX250MA4	—	—	—	—	202000	226600	77900	404
7.2	66800	0.9	206	314ML3	—	IEC250M4	BX250MA4	—	—	—	—	132000	158300	46600	380
8.3	58000	2.5	179	317ML3	—	IEC250M4	BX250MA4	—	—	—	—	314300	333900	74200	414
8.5	56200	1.1	174	314ML3	—	IEC250M4	BX250MA4	—	—	—	—	132000	158300	44100	380
8.5	56500	1.3	174	315ML3	—	IEC250M4	BX250MA4	—	—	—	—	132000	158300	44100	392
8.5	56500	1.8	174	316ML3	—	IEC250M4	BX250MA4	—	—	—	—	202000	226600	73500	404
8.9	53700	2.3	166	317ML3	—	IEC250M4	BX250MA4	—	—	—	—	314300	333900	72300	414
9.0	53200	1.1	164	314ML3	—	IEC250M4	BX250MA4	—	—	—	—	132000	158300	43200	380
9.0	53500	1.7	165	315ML3	—	IEC250M4	BX250MA4	—	—	—	—	132000	158300	43300	392
9.0	53500	2.1	165	316ML3	—	IEC250M4	BX250MA4	—	—	—	—	202000	226600	72200	404
9.0	53400	2.1	165	—	317MR3C	IEC250M4	BX250MA4	—	—	—	—	314300	333900	72100	416
9.4	50900	0.9	157	—	314MR3C	IEC250M4	BX250MA4	—	—	—	—	132000	158300	42600	382
9.4	50900	1.2	157	—	315MR3C	IEC250M4	BX250MA4	—	—	—	—	132000	158300	42600	394
10.6	45000	2.0	139	315ML3	—	IEC250M4	BX250MA4	—	—	—	—	129500	155400	40900	392
10.6	45000	2.6	139	316ML3	—	IEC250M4	BX250MA4	—	—	—	—	198200	222400	68200	404
10.7	44800	1.6	138	314ML3	—	IEC250M4	BX250MA4	—	—	—	—	129400	155100	40800	380
10.7	45000	2.7	139	—	317MR3C	IEC250M4	BX250MA4	—	—	—	—	308300	327500	68100	416
11.0	43800	1.4	135	—	314MR3C	IEC250M4	BX250MA4	—	—	—	—	128400	154000	40500	382
11.0	43800	1.7	135	—	315MR3C	IEC250M4	BX250MA4	—	—	—	—	128400	154000	40500	394
11.0	43800	2.2	135	—	316MR3C	IEC250M4	BX250MA4	—	—	—	—	196600	220500	67500	406
12.4	38500	2.8	119	—	317MR3B	IEC250M4	BX250MA4	—	—	—	—	294400	312700	64700	416
12.6	38000	2.9	117	316ML3	—	IEC250M4	BX250MA4	—	—	—	—	188300	211200	64400	404
12.8	37400	2.7	115	—	317MR3C	IEC250M4	BX250MA4	—	—	—	—	291600	309800	64100	416
13.0	36800	1.3	113	—	314MR3B	IEC250M4	BX250MA4	—	—	—	—	121900	146200	38200	382
13.0	36900	1.6	114	—	314MR3C	IEC250M4	BX250MA4	—	—	—	—	122000	146300	38300	382
13.0	36800	1.6	113	—	315MR3B	IEC250M4	BX250MA4	—	—	—	—	121900	146200	38200	394
13.0	36900	2.0	114	—	315MR3C	IEC250M4	BX250MA4	—	—	—	—	122000	146300	38300	394
13.0	36900	2.6	114	316ML3	—	IEC250M4	BX250MA4	—	—	—	—	186800	209500	63800	404
13.0	36900	2.5	114	—	316MR3C	IEC250M4	BX250MA4	—	—	—	—	186700	209500	63800	406
13.7	34900	1.6	108	314ML3	—	IEC250M4	BX250MA4	—	—	—	—	120000	143900	37600	380
13.7	34900	1.6	108	—	314MR3C	IEC250M4	BX250MA4	—	—	—	—	120000	143900	37600	382
13.7	35100	2.4	108	315ML3	—	IEC250M4	BX250MA4	—	—	—	—	120200	144200	37600	392
13.7	34900	2.4	108	—	315MR3C	IEC250M4	BX250MA4	—	—	—	—	120000	143900	37600	394
13.7	34900	2.7	108	—	316MR3C	IEC250M4	BX250MA4	—	—	—	—	183600	206000	62600	406
13.7	35000	2.7	108	—	317MR3C	IEC250M4	BX250MA4	—	—	—	—	286100	303900	62700	416
14.8	32500	3.0	100	—	317MR3B	IEC250M4	BX250MA4	—	—	—	—	279600	297100	61100	416
15.2	31600	1.8	97.6	—	314MR3B	IEC250M4	BX250MA4	—	—	—	—	116500	139700	36400	382
15.2	31600	2.3	97.6	—	315MR3B	IEC250M4	BX250MA4	—	—	—	—	116500	139700	36400	394
15.2	31600	2.8	97.6	—	316MR3B	IEC250M4	BX250MA4	—	—	—	—	178300	200000	60600	406
16.0	30000	1.8	92.7	314ML3	—	IEC250M4	BX250MA4	—	—	—	—	114700	137600	35700	380
16.2	29600	2.7	91.3	315ML3	—	IEC250M4	BX250MA4	—	—	—	—	114200	136900	35600	392
16.3	29400	2.1	90.7	—	314MR3C	IEC250M4	BX250MA4	—	—	—	—	114000	136700	35500	382
16.3	29400	2.6	90.7	—	315MR3C	IEC250M4	BX250MA4	—	—	—	—	114000	136700	35500	394
16.3	29400	2.7	90.7	—	316MR3C	IEC250M4	BX250MA4	—	—	—	—	174400	195700	59100	406
16.5	29100	2.7	89.8	—	317MR3C	IEC250M4	BX250MA4	—	—	—	—	270600	287500	59000	416

* The technical information shall be considered as indicative, the configurations should be matching the data provided by motors manufacturers on rated powers greater than 22 kW.

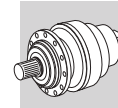

$P_1 = 55 \text{ kW}$

n_2 min ⁻¹	M_2 Nm	S	i	IE2*		IE3		IE2		IE3		R _{n2} [N]					
				MC	MZ	HC/PC	HZ/PZ	FZ									
16.7	28700	2.7	88.7	—	316MR3C	IEC250M4	BX250MA4	—	—	—	—	173300	194400	58700	406		
17.8	27000	3.0	83.3	—	317MR3B	IEC250M4	BX250MA4	—	—	—	—	264500	281000	57500	416		
18.0	26600	2.0	82.3	—	314MR3B	IEC250M4	BX250MA4	—	—	—	—	110700	132700	34300	382		
18.0	26600	2.6	82.3	—	315MR3B	IEC250M4	BX250MA4	—	—	—	—	110700	132700	34300	394		
18.0	26600	3.0	82.3	—	316MR3B	IEC250M4	BX250MA4	—	—	—	—	169400	190000	57200	406		
18.9	25300	3.0	78.1	—	317MR3B	IEC250M4	BX250MA4	—	—	—	—	259500	275600	56300	416		
19.0	25200	2.1	77.8	—	314MR3B	IEC250M4	BX250MA4	—	—	—	—	108800	130500	33700	382		
19.0	25200	2.9	77.8	—	315MR3B	IEC250M4	BX250MA4	—	—	—	—	108800	130500	33700	394		
19.0	25200	3.0	77.8	—	316MR3B	IEC250M4	BX250MA4	—	—	—	—	166600	186800	56200	406		
20.0	23900	2.1	73.9	314ML3	—	IEC250M4	BX250MA4	—	—	—	—	107200	128500	33100	380		
20.9	22900	2.2	70.7	—	314MR3C	IEC250M4	BX250MA4	—	—	—	—	105800	126800	32700	382		
20.9	22900	2.7	70.7	—	315MR3C	IEC250M4	BX250MA4	—	—	—	—	105800	126800	32700	394		
20.9	22900	2.7	70.7	—	316MR3C	IEC250M4	BX250MA4	—	—	—	—	161800	181600	54400	406		
21.5	22300	2.7	68.9	—	317MR3C	IEC250M4	BX250MA4	—	—	—	—	249900	265500	54000	416		
22.6	21200	2.4	65.5	—	314MR3B	IEC250M4	BX250MA4	—	—	—	—	103400	124000	31800	382		
22.6	21200	3.0	65.5	—	315MR3B	IEC250M4	BX250MA4	—	—	—	—	103400	124000	31800	394		
22.6	21200	3.0	65.5	—	316MR3B	IEC250M4	BX250MA4	—	—	—	—	158200	177500	53100	406		
22.8	21000	3.0	64.9	—	317MR3B	IEC250M4	BX250MA4	—	—	—	—	245400	260700	52900	416		
23.1	20800	3.0	64.1	—	316MR3B	IEC250M4	BX250MA4	—	—	—	—	157100	176300	52700	406		
23.6	20300	2.4	62.6	314ML3	—	IEC250M4	BX250MA4	—	—	—	—	102000	122300	31400	380		
29.0	16500	2.4	51.1	—	314MR3B	IEC250M4	BX250MA4	—	—	—	—	95900	115000	29300	382		
29.0	16500	3.0	51.1	—	315MR3B	IEC250M4	BX250MA4	—	—	—	—	95900	115000	29300	394		
29.0	16500	3.0	51.1	—	316MR3B	IEC250M4	BX250MA4	—	—	—	—	146800	164700	48800	406		
29.7	16100	3.0	49.8	—	317MR3B	IEC250M4	BX250MA4	—	—	—	—	226700	240800	48400	416		
32	15600	1.1	46.7	310ML2	—	IEC250M4	BX250MA4	—	—	—	—	55200	70000	20500	344		
37	13500	2.2	40.5	313ML2	—	IEC250M4	BX250MA4	—	—	—	—	96300	112800	24100	368		
38	12900	1.4	38.6	310ML2	—	IEC250M4	BX250MA4	—	—	—	—	52100	66100	19300	344		
38	13000	2.1	38.8	311ML2	—	IEC250M4	BX250MA4	—	—	—	—	65600	83700	19300	356		
45	10900	1.9	32.6	310ML2	—	IEC250M4	BX250MA4	—	—	—	—	49500	62800	18200	344		
45	10900	2.6	32.7	311ML2	—	IEC250M4	BX250MA4	—	—	—	—	62300	79500	18200	356		
48	10200	1.7	30.7	310ML2	—	IEC250M4	BX250MA4	—	—	—	—	48600	61700	17900	344		
53	9350	2.2	28.0	310ML2	—	IEC250M4	BX250MA4	—	—	—	—	47300	60000	17300	344		
56	8830	2.7	26.4	—	313MR2C	IEC250M4	BX250MA4	—	—	—	—	84700	99200	20900	370		
58	8470	2.0	25.4	310ML2	—	IEC250M4	BX250MA4	—	—	—	—	45900	58300	16800	344		
58	8460	2.1	25.3	—	310MR2C	IEC250M4	BX250MA4	—	—	—	—	45900	58200	16800	346		
58	8510	2.7	25.5	311ML2	—	IEC250M4	BX250MA4	—	—	—	—	57800	73700	16800	356		
58	8460	2.7	25.3	—	311MR2C	IEC250M4	BX250MA4	—	—	—	—	57700	73600	16800	358		
67	7340	2.7	22.0	—	313MR2C	IEC250M4	BX250MA4	—	—	—	—	80100	93900	19700	370		
68	7290	2.2	21.8	310ML2	—	IEC250M4	BX250MA4	—	—	—	—	43900	55700	15900	344		
69	7130	2.6	21.3	—	310MR2C	IEC250M4	BX250MA4	—	—	—	—	43600	55300	15800	346		
69	7170	2.9	21.5	311ML2	—	IEC250M4	BX250MA4	—	—	—	—	54900	70100	15900	356		
69	7130	2.7	21.3	—	311MR2C	IEC250M4	BX250MA4	—	—	—	—	54800	69900	15800	358		
78	6380	3.0	19.1	—	313MR2B	IEC250M4	BX250MA4	—	—	—	—	76800	90000	18800	370		
81	6110	3.0	18.3	—	311MR2B	IEC250M4	BX250MA4	—	—	—	—	52300	66800	15000	358		
85	5810	2.7	17.4	310ML2	—	IEC250M4	BX250MA4	—	—	—	—	41000	52000	14800	344		
88	5630	2.7	16.8	—	313MR2C	IEC250M4	BX250MA4	—	—	—	—	74000	86700	18000	370		
89	5560	2.7	16.6	—	310MR2C	IEC250M4	BX250MA4	—	—	—	—	40500	51300	14600	346		
89	5560	2.7	16.6	—	311MR2C	IEC250M4	BX250MA4	—	—	—	—	50900	64900	14600	358		
93	5300	3.0	15.9	—	313MR2B	IEC250M4	BX250MA4	—	—	—	—	72700	85200	17600	370		
96	5150	3.0	15.4	—	311MR2B	IEC250M4	BX250MA4	—	—	—	—	49700	63400	14200	358		
122	4060	3.0	12.2	—	313MR2B	IEC250M4	BX250MA4	—	—	—	—	67100	78600	16100	370		
123	4010	3.0	12.0	—	311MR2B	IEC250M4	BX250MA4	—	—	—	—	46100	58900	13100	358		
197	2580	1.6	7.50	306L1	—	IEC250M4	BX250MA4	—	—	9250	10500	23300	26900	6010	308		
238	2150	2.7	6.23	307L1	—	IEC250M4	BX250MA4	—	—	10400	13000	26100	34300	7270	320		
239	2130	2.0	6.20	306L1	—	IEC250M4	BX250MA4	—	—	8680	9900	22000	25400	5640	308		
278	1840	2.2	5.33	306L1	—	IEC250M4	BX250MA4	—	—	8260	9410	21000	24300	5370	308		
348	1460	2.7	4.25	306L1	—	IEC250M4	BX250MA4	—	—	7660	8730	19600	22700	4970	308		

* The technical information shall be considered as indicative, the configurations should be matching the data provided by motors manufacturers on rated powers greater than 22 kW.



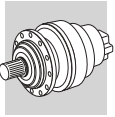

A

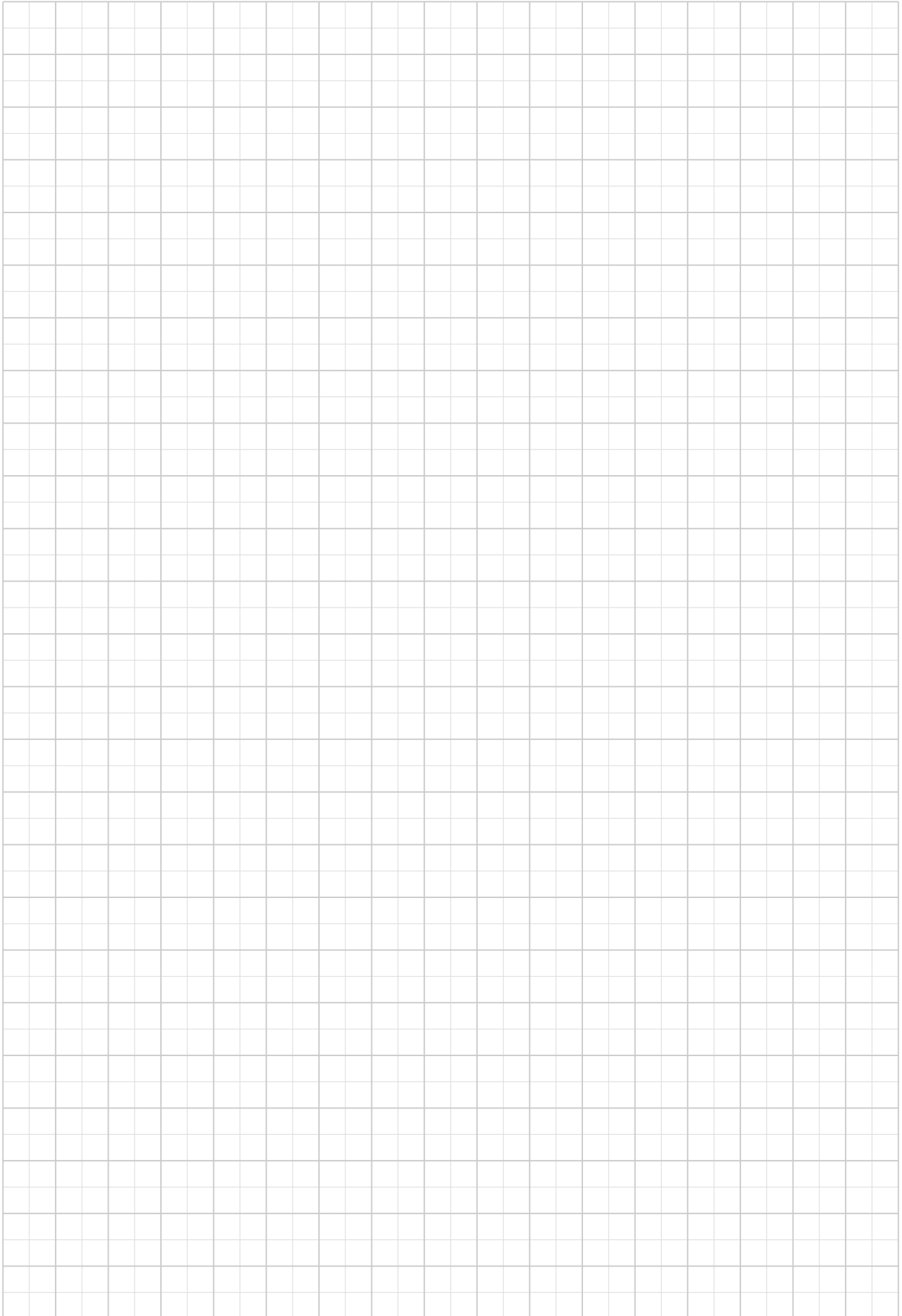

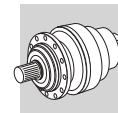

25.2 3/V_M - 3/A GEARMOTOR RATING CHARTS

Reading the rating chart.

1
 ↓

$P_1 = 11 \text{ kW}$

n_2 min ⁻¹	M_2 Nm	S	i			IE2		IE3		R _{n2} [N]					
						BE160M4	BX160MB4	ME5SA4	MX5SB4	MC/PC	MZ/PZ	HC	HZ	FZ	
3.7	23700	1.9	397	3/V14ML3	—	BE160M4	BX160MB4	—	—	—	—	137400	164800	57800	384
3.8	23300	2.7	386	3/V15ML3	—	BE160M4	BX160MB4	—	—	—	—	136900	164100	57300	396
4.0	21300	1.9	370	3/V13ML3	—	BE160M4	BX160MB4	—	—	—	—	146300	171500	50200	372
8.1	11800	0.9	180	—	3/A07L2	BE160M4	BX160MB4	ME5SA4	MX5SB4	30000	37500	67500	88800	22200	325
10.5	9190	1.2	140	—	3/A07L2	BE160M4	BX160MB4	ME5SA4	MX5SB4	29300	36700	66200	87000	20400	325

2
↑

3
↑

4
↑

5
↑

6
↑

7
↑

8
↑

9
↑

10
↑

11
↑

1 Power applied at gearbox input shaft

2 Gearbox output speed

Torque delivered at output shaft:

3 - specified service factor
- 10000 h theoretical lifetime

4 Service factor

5 Gear ratio

6 Model and frame size of combined planetary + worm gear unit

7 Model and frame size of combined planetary + helical bevel gear unit

8 IEC motor size and pole number

9 Compact motor size and pole number

Permitted overhung loading on output shaft, based on:

10 - service factor $f_s=1$
- 10000 h theoretical lifetime
- speed of output n_2

For forces not applied at shaft midpoint, see diagrams provided in the specific gearbox overall dimensioning pages

11 Dimensions page. Gearmotor overall dimensions refer to matches with BONFIGLIOLI motors only

A

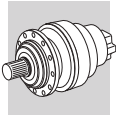

The selection of motors takes into account the requirements of Regulation 2009/125/CE (see section M of this catalogue). When the motor rated power is below 0,12kW, **BN/M** motors can be provided. Starting from 1st July 2021 the regulation 2009/125/CE will apply also to motors equipped with brake, and 8 poles motors.

A

$P_1 = 0.12 \text{ kW}$

n_2 min ⁻¹	M_2 Nm	S	i	Motor icons		IE1		IE2		R_{n2} [N]					MC/PC	MZ/PZ	HZ	FZ	Icon
				IE1	IE2	IE1	IE2	MC/PC	MZ/PZ	HC	HZ	FZ							
0.58	1180	1.5	2337	3/V01L3	—	BN63A4	BE63A4	—	—	8710	8710	28800	31500	8000	266				
0.72	940	0.9	1869	3/V00L3	—	BN63A4	BE63A4	—	—	8440	8440	27900	32500	8000	256				
0.72	940	1.8	1869	3/V01L3	—	BN63A4	BE63A4	—	—	8440	8440	27900	30500	8000	266				
0.90	800	1.1	1495	3/V00L3	—	BN63A4	BE63A4	—	—	8180	8180	27000	31400	7990	256				
0.90	800	2.1	1495	3/V01L3	—	BN63A4	BE63A4	—	—	8180	8180	27000	29600	7990	266				
0.98	700	1.8	1381	3/V00L3	—	BN63A4	BE63A4	—	—	8080	8080	26700	31100	7780	256				
0.98	700	2.7	1381	3/V01L3	—	BN63A4	BE63A4	—	—	8080	8080	26700	29200	7780	266				
1.1	640	1.3	1198	3/V00L3	—	BN63A4	BE63A4	—	—	7920	7920	26200	30500	7420	256				
1.1	640	2.6	1198	3/V01L3	—	BN63A4	BE63A4	—	—	7920	7920	26200	28600	7420	266				
1.2	560	2.1	1107	3/V00L3	—	BN63A4	BE63A4	—	—	7830	7830	25900	30100	7230	256				
1.4	600	1.3	997	3/V00L3	—	BN63A4	BE63A4	—	—	7720	7720	25500	29700	6980	256				
1.4	600	2.7	997	3/V01L3	—	BN63A4	BE63A4	—	—	7720	7720	25500	27900	6980	266				
1.5	455	1.7	903	3/V00L3	—	BN63A4	BE63A4	—	—	7610	7610	25200	29300	6760	256				
1.5	455	2.7	903	3/V01L3	—	BN63A4	BE63A4	—	—	7610	7610	25200	27500	6760	266				
1.7	410	2.7	818	3/V00L3	—	BN63A4	BE63A4	—	—	7500	7500	24800	28900	6540	256				
2.0	520	1.2	660	—	3/A00L2	BN63A4	BE63A4	M05A4	ME05A4	7270	7270	24100	28000	6080	257				
2.0	530	2.2	665	—	3/A01L2	BN63A4	BE63A4	M05A4	ME05A4	7280	7280	24100	26300	6100	267				
2.0	390	2.8	689	3/V00L3	—	BN63A4	BE63A4	—	—	7320	7320	24200	28200	6170	256				
2.4	320	2.3	562	3/V00L3	—	BN63A4	BE63A4	—	—	7110	7110	23500	27300	5770	256				
2.5	435	1.4	550	—	3/A00L2	BN63A4	BE63A4	M05A4	ME05A4	7090	7090	23400	27300	5730	257				
2.5	420	2.7	533	—	3/A01L2	BN63A4	BE63A4	M05A4	ME05A4	7060	7060	23300	25500	5660	267				
3.1	350	2.0	441	—	3/A00L2	BN63A4	BE63A4	M05A4	ME05A4	6870	6870	22700	26400	5320	257				
3.4	310	2.7	393	—	3/A01L2	BN63A4	BE63A4	M05A4	ME05A4	6760	6760	22300	24400	5120	267				
3.5	310	1.7	391	—	3/A00L2	BN63A4	BE63A4	M05A4	ME05A4	6750	6750	22300	26000	5110	257				
3.7	290	1.9	369	—	3/A00L2	BN63A4	BE63A4	M05A4	ME05A4	6700	6700	22100	25800	5010	257				
4.2	250	1.7	319	—	3/A00L2	BN63A4	BE63A4	M05A4	ME05A4	6560	6560	21700	25200	4770	257				
4.6	235	2.8	296	—	3/A00L2	BN63A4	BE63A4	M05A4	ME05A4	6500	6500	21500	25000	4660	257				
5.3	200	2.7	253	—	3/A00L2	BN63A4	BE63A4	M05A4	ME05A4	6500	6500	21500	25000	4420	257				

$P_1 = 0.12 \text{ kW}$

n_2 min ⁻¹	M_2 Nm	S	i	Motor icons		IE3		IE3		R_{n2} [N]					MC/PC	MZ/PZ	HZ	FZ	Icon
				IE3	IE3	MC/PC	MZ/PZ	HC	HZ	FZ									
0.58	1180	1.5	2337	3/V01L3	—	BXN63MA4	—	—	—	8710	8710	28800	31500	8000	266				
0.72	940	0.9	1869	3/V00L3	—	BXN63MA4	—	—	—	8440	8440	27900	32500	8000	256				
0.72	940	1.8	1869	3/V01L3	—	BXN63MA4	—	—	—	8440	8440	27900	30500	8000	266				
0.90	800	1.1	1495	3/V00L3	—	BXN63MA4	—	—	—	8180	8180	27000	31400	7990	256				
0.90	800	2.1	1495	3/V01L3	—	BXN63MA4	—	—	—	8180	8180	27000	29600	7990	266				
0.98	700	1.8	1381	3/V00L3	—	BXN63MA4	—	—	—	8080	8080	26700	31100	7780	256				
0.98	700	2.7	1381	3/V01L3	—	BXN63MA4	—	—	—	8080	8080	26700	29200	7780	266				
1.1	640	1.3	1198	3/V00L3	—	BXN63MA4	—	—	—	7920	7920	26200	30500	7420	256				
1.1	640	2.6	1198	3/V01L3	—	BXN63MA4	—	—	—	7920	7920	26200	28600	7420	266				
1.2	560	2.1	1107	3/V00L3	—	BXN63MA4	—	—	—	7830	7830	25900	30100	7230	256				

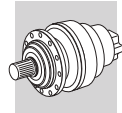

$P_1 = 0.12 \text{ kW}$

n_2 min ⁻¹	M_2 Nm	S	i					R_{n_2} [N]						
				IE3	IE3	IE3	IE3	MC/PC	MZ/PZ	HC	HZ	FZ		
1.4	600	1.3	997	3/V00L3	—	BXN63MA4	—	—	7720	7720	25500	29700	6980	256
1.4	600	2.7	997	3/V01L3	—	BXN63MA4	—	—	7720	7720	25500	27900	6980	266
1.5	455	1.7	903	3/V00L3	—	BXN63MA4	—	—	7610	7610	25200	29300	6760	256
1.5	455	2.7	903	3/V01L3	—	BXN63MA4	—	—	7610	7610	25200	27500	6760	266
1.7	410	2.7	818	3/V00L3	—	BXN63MA4	—	—	7500	7500	24800	28900	6540	256
2.0	520	1.2	660	—	3/A00L2	BXN63MA4	—	MXN05MA4	7270	7270	24100	28000	6080	257
2.0	530	2.2	665	—	3/A01L2	BXN63MA4	—	MXN05MA4	7280	7280	24100	26300	6100	267
2.0	390	2.8	689	3/V00L3	—	BXN63MA4	—	—	7320	7320	24200	28200	6170	256
2.4	320	2.3	562	3/V00L3	—	BXN63MA4	—	—	7110	7110	23500	27300	5770	256
2.5	435	1.4	550	—	3/A00L2	BXN63MA4	—	MXN05MA4	7090	7090	23400	27300	5730	257
2.5	420	2.7	533	—	3/A01L2	BXN63MA4	—	MXN05MA4	7060	7060	23300	25500	5660	267
3.1	350	2.0	441	—	3/A00L2	BXN63MA4	—	MXN05MA4	6870	6870	22700	26400	5320	257
3.4	310	2.7	393	—	3/A01L2	BXN63MA4	—	MXN05MA4	6760	6760	22300	24400	5120	267
3.5	310	1.7	391	—	3/A00L2	BXN63MA4	—	MXN05MA4	6750	6750	22300	26000	5110	257
3.7	290	1.9	369	—	3/A00L2	BXN63MA4	—	MXN05MA4	6700	6700	22100	25800	5010	257
4.2	250	1.7	319	—	3/A00L2	BXN63MA4	—	MXN05MA4	6560	6560	21700	25200	4770	257
4.6	235	2.8	296	—	3/A00L2	BXN63MA4	—	MXN05MA4	6500	6500	21500	25000	4660	257
5.3	200	2.7	253	—	3/A00L2	BXN63MA4	—	MXN05MA4	6500	6500	21500	25000	4420	257



$P_1 = 0.18 \text{ kW}$

n_2 min ⁻¹	M_2 Nm	S	i					R_{n_2} [N]							
				IE1	IE2	IE1	IE2	MC/PC	MZ/PZ	HC	HZ	FZ			
0.56	1800	1.0	2337	3/V01L3	—	BN63B4	BE63B4	—	—	8710	8710	28800	31500	8000	266
0.71	1440	1.2	1869	3/V01L3	—	BN63B4	BE63B4	—	—	8440	8440	27900	30500	8000	266
0.88	1230	1.4	1495	3/V01L3	—	BN63B4	BE63B4	—	—	8180	8180	27000	29600	7990	266
0.96	1060	1.2	1381	3/V00L3	—	BN63B4	BE63B4	—	—	8080	8080	26700	31100	7780	256
0.96	1060	1.8	1381	3/V01L3	—	BN63B4	BE63B4	—	—	8080	8080	26700	29200	7780	266
1.1	980	1.7	1198	3/V01L3	—	BN63B4	BE63B4	—	—	7920	7920	26200	28600	7420	266
1.2	850	1.4	1107	3/V00L3	—	BN63B4	BE63B4	—	—	7830	7830	25900	30100	7230	256
1.2	910	2.2	1105	3/V01L3	—	BN63B4	BE63B4	—	—	7830	7830	25900	28300	7230	266
1.3	910	1.7	997	3/V01L3	—	BN63B4	BE63B4	—	—	7720	7720	25500	27900	6980	266
1.5	700	1.1	903	3/V00L3	—	BN63B4	BE63B4	—	—	7610	7610	25200	29300	6760	256
1.5	700	1.8	903	3/V01L3	—	BN63B4	BE63B4	—	—	7610	7610	25200	27500	6760	266
1.6	630	1.8	818	3/V00L3	—	BN63B4	BE63B4	—	—	7500	7500	24800	28900	6540	256
1.7	730	2.1	799	3/V01L3	—	BN63B4	BE63B4	—	—	7480	7480	24700	27000	6480	266
1.8	880	2.0	731	—	3/A03L2	BN63B4	BE63B4	—	—	23900	27300	46000	54500	18900	277
1.9	600	1.8	689	3/V00L3	—	BN63B4	BE63B4	—	—	7320	7320	24200	28200	6170	256
1.9	600	2.9	689	3/V01L3	—	BN63B4	BE63B4	—	—	7320	7320	24200	26500	6170	266
2.0	810	1.4	665	—	3/A01L2	BN63B4	BE63B4	M05B4	ME05B4	7280	7280	24100	26300	6100	267
2.0	540	2.0	654	3/V00L3	—	BN63B4	BE63B4	—	—	7270	7270	24000	27900	6070	256
2.0	540	2.2	654	3/V01L3	—	BN63B4	BE63B4	—	—	7270	7270	24000	26300	6070	266
2.2	730	2.5	605	—	3/A03L2	BN63B4	BE63B4	—	—	23200	26500	44800	53100	17700	277
2.3	690	2.5	574	—	3/A03L2	BN63B4	BE63B4	—	—	23000	26300	44400	52700	17400	277
2.3	490	1.5	562	3/V00L3	—	BN63B4	BE63B4	—	—	7110	7110	23500	27300	5770	256
2.3	490	2.9	562	3/V01L3	—	BN63B4	BE63B4	—	—	7110	7110	23500	25700	5770	266
2.5	650	1.7	533	—	3/A01L2	BN63B4	BE63B4	M05B4	ME05B4	7060	7060	23300	25500	5660	267
2.6	440	2.4	509	3/V00L3	—	BN63B4	BE63B4	—	—	7010	7010	23200	27000	5580	256
2.6	440	2.9	509	3/V01L3	—	BN63B4	BE63B4	—	—	7010	7010	23200	25300	5580	266
2.7	600	2.9	495	—	3/A03L2	BN63B4	BE63B4	—	—	22600	25800	43500	51600	16600	277
2.9	550	2.1	454	—	3/A01L2	BN63B4	BE63B4	M05B4	ME05B4	6900	6900	22800	24900	5370	267
3.0	530	1.3	441	—	3/A00L2	BN63B4	BE63B4	M05B4	ME05B4	6870	6870	22700	26400	5320	257
3.0	355	2.0	436	3/V00L3	—	BN63B4	BE63B4	—	—	6860	6860	22700	26400	5300	256
3.2	360	2.8	415	3/V00L3	—	BN63B4	BE63B4	—	—	6810	6810	22500	26200	5210	256
3.4	475	1.1	391	—	3/A00L2	BN63B4	BE63B4	M05B4	ME05B4	6750	6750	22300	26000	5110	257
3.4	475	1.7	393	—	3/A01L2	BN63B4	BE63B4	M05B4	ME05B4	6760	6760	22300	24400	5120	267
3.6	445	1.3	369	—	3/A00L2	BN63B4	BE63B4	M05B4	ME05B4	6700	6700	22100	25800	5010	257
4.1	385	1.1	319	—	3/A00L2	BN63B4	BE63B4	M05B4	ME05B4	6560	6560	21700	25200	4770	257
4.5	360	1.8	296	—	3/A00L2	BN63B4	BE63B4	M05B4	ME05B4	6500	6500	21500	25000	4660	257
5.2	305	1.8	253	—	3/A00L2	BN63B4	BE63B4	M05B4	ME05B4	6500	6500	21500	25000	4420	257
6.0	265	2.3	219	—	3/A00L2	BN63B4	BE63B4	M05B4	ME05B4	6500	6500	21500	25000	4210	257
6.5	245	2.6	203	—	3/A00L2	BN63B4	BE63B4	M05B4	ME05B4	6500	6500	21500	25000	4100	257
7.7	205	2.7	171	—	3/A00L2	BN63B4	BE63B4	M05B4	ME05B4	6500	6500	21500	25000	3880	257

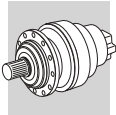





$P_1 = 0.18 \text{ kW}$

n_2 min ⁻¹	M_2 Nm	S	i					Rn_2 [N]						
								IE3	IE3	MC/PC	MZ/PZ	HC		HZ
0.56	1800	1.0	2337	3/V01L3	—	BXN63MB4	—	—	8710	8710	28800	31500	8000	266
0.71	1440	1.2	1869	3/V01L3	—	BXN63MB4	—	—	8440	8440	27900	30500	8000	266
0.88	1230	1.4	1495	3/V01L3	—	BXN63MB4	—	—	8180	8180	27000	29600	7990	266
0.96	1060	1.2	1381	3/V00L3	—	BXN63MB4	—	—	8080	8080	26700	31100	7780	256
0.96	1060	1.8	1381	3/V01L3	—	BXN63MB4	—	—	8080	8080	26700	29200	7780	266
1.1	980	1.7	1198	3/V01L3	—	BXN63MB4	—	—	7920	7920	26200	28600	7420	266
1.2	850	1.4	1107	3/V00L3	—	BXN63MB4	—	—	7830	7830	25900	30100	7230	256
1.2	910	2.2	1105	3/V01L3	—	BXN63MB4	—	—	7830	7830	25900	28300	7230	266
1.3	910	1.7	997	3/V01L3	—	BXN63MB4	—	—	7720	7720	25500	27900	6980	266
1.5	700	1.1	903	3/V00L3	—	BXN63MB4	—	—	7610	7610	25200	29300	6760	256
1.5	700	1.8	903	3/V01L3	—	BXN63MB4	—	—	7610	7610	25200	27500	6760	266
1.6	630	1.8	818	3/V00L3	—	BXN63MB4	—	—	7500	7500	24800	28900	6540	256
1.7	730	2.1	799	3/V01L3	—	BXN63MB4	—	—	7480	7480	24700	27000	6480	266
1.8	880	2.0	731	—	3/A03L2	BXN63MB4	—	—	23900	27300	46000	54500	18900	277
1.9	600	1.8	689	3/V00L3	—	BXN63MB4	—	—	7320	7320	24200	28200	6170	256
1.9	600	2.9	689	3/V01L3	—	BXN63MB4	—	—	7320	7320	24200	26500	6170	266
2.0	810	1.4	665	—	3/A01L2	BXN63MB4	—	MXN05MB4	7280	7280	24100	26300	6100	267
2.0	540	2.0	654	3/V00L3	—	BXN63MB4	—	—	7270	7270	24000	27900	6070	256
2.0	540	2.2	654	3/V01L3	—	BXN63MB4	—	—	7270	7270	24000	26300	6070	266
2.2	730	2.5	605	—	3/A03L2	BXN63MB4	—	—	23200	26500	44800	53100	17700	277
2.3	690	2.5	574	—	3/A03L2	BXN63MB4	—	—	23000	26300	44400	52700	17400	277
2.3	490	1.5	562	3/V00L3	—	BXN63MB4	—	—	7110	7110	23500	27300	5770	256
2.3	490	2.9	562	3/V01L3	—	BXN63MB4	—	—	7110	7110	23500	25700	5770	266
2.5	650	1.7	533	—	3/A01L2	BXN63MB4	—	MXN05MB4	7060	7060	23300	25500	5660	267
2.6	440	2.4	509	3/V00L3	—	BXN63MB4	—	—	7010	7010	23200	27000	5580	256
2.6	440	2.9	509	3/V01L3	—	BXN63MB4	—	—	7010	7010	23200	25300	5580	266
2.7	600	2.9	495	—	3/A03L2	BXN63MB4	—	—	22600	25800	43500	51600	16600	277
2.9	550	2.1	454	—	3/A01L2	BXN63MB4	—	MXN05MB4	6900	6900	22800	24900	5370	267
3.0	530	1.3	441	—	3/A00L2	BXN63MB4	—	MXN05MB4	6870	6870	22700	26400	5320	257
3.0	355	2.0	436	3/V00L3	—	BXN63MB4	—	—	6860	6860	22700	26400	5300	256
3.2	360	2.8	415	3/V00L3	—	BXN63MB4	—	—	6810	6810	22500	26200	5210	256
3.4	475	1.1	391	—	3/A00L2	BXN63MB4	—	MXN05MB4	6750	6750	22300	26000	5110	257
3.4	475	1.7	393	—	3/A01L2	BXN63MB4	—	MXN05MB4	6760	6760	22300	24400	5120	267
3.6	445	1.3	369	—	3/A00L2	BXN63MB4	—	MXN05MB4	6700	6700	22100	25800	5010	257
4.1	385	1.1	319	—	3/A00L2	BXN63MB4	—	MXN05MB4	6560	6560	21700	25200	4770	257
4.5	360	1.8	296	—	3/A00L2	BXN63MB4	—	MXN05MB4	6500	6500	21500	25000	4660	257
5.2	305	1.8	253	—	3/A00L2	BXN63MB4	—	MXN05MB4	6500	6500	21500	25000	4420	257
6.0	265	2.3	219	—	3/A00L2	BXN63MB4	—	MXN05MB4	6500	6500	21500	25000	4210	257
6.5	245	2.6	203	—	3/A00L2	BXN63MB4	—	MXN05MB4	6500	6500	21500	25000	4100	257
7.7	205	2.7	171	—	3/A00L2	BXN63MB4	—	MXN05MB4	6500	6500	21500	25000	3880	257

$P_1 = 0.25 \text{ kW}$

n_2 min ⁻¹	M_2 Nm	S	i					Rn_2 [N]							
								IE1	IE2	IE1	IE2	MC/PC		MZ/PZ	HC
0.53	3080	2.3	2588	3/V06L3	—	BN71A4	BE71A4	—	—	34000	38800	77500	89500	35000	312
0.58	2770	1.1	2366	3/V04L3	—	BN71A4	BE71A4	—	—	28200	32200	54400	64500	24000	288
0.62	2620	1.7	2232	3/V05L3	—	BN71A4	BE71A4	—	—	28000	32000	53900	63900	24000	300
0.69	2190	1.1	2009	3/V03L3	—	BN71A4	BE71A4	—	—	27600	31500	53100	63000	24000	276
0.73	2220	1.4	1893	3/V04L3	—	BN71A4	BE71A4	—	—	27300	31200	52700	62400	24000	288
0.77	2090	2.2	1786	3/V05L3	—	BN71A4	BE71A4	—	—	27100	31000	52300	61900	24000	300
0.78	2220	1.3	1774	3/V04L3	—	BN71A4	BE71A4	—	—	27100	30900	52200	61900	24000	288
0.80	1880	1.5	1728	3/V03L3	—	BN71A4	BE71A4	—	—	27000	30800	52000	61600	24000	276
0.82	2100	2.1	1674	3/V05L3	—	BN71A4	BE71A4	—	—	26800	30700	51800	61400	24000	300
0.86	1760	1.4	1610	3/V03L3	—	BN71A4	BE71A4	—	—	26700	30500	51500	61000	24000	276
0.90	1800	2.1	1536	3/V04L3	—	BN71A4	BE71A4	—	—	26500	30300	51100	60600	24000	288
0.92	1630	1.1	1495	3/V01L3	—	BN71A4	BE71A4	—	—	8180	8180	27000	29600	7990	266
0.96	1680	2.8	1431	3/V05L3	—	BN71A4	BE71A4	—	—	26300	30000	50600	60000	23600	300
0.97	1780	1.7	1419	3/V04L3	—	BN71A4	BE71A4	—	—	26200	30000	50600	59900	23600	288
1.0	1420	1.3	1381	3/V01L3	—	BN71A4	BE71A4	—	—	8080	8080	26700	29200	7780	266
1.0	1510	1.9	1385	3/V03L3	—	BN71A4	BE71A4	—	—	26100	29900	50400	59700	23400	276
1.1	1440	2.5	1231	3/V04L3	—	BN71A4	BE71A4	—	—	25700	29400	49500	58700	22500	288

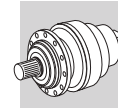

$P_1 = 0.25 \text{ kW}$

n_2 min ⁻¹	M_2 Nm	S	i	[Image]		IE1		IE2		R _{n2} [N]					[Icon]
				[Image]	[Image]	[Image]	[Image]	MC/PC	MZ/PZ	HC	HZ	FZ			
1.2	1140	1.0	1107	3/V00L3	—	BN71A4	BE71A4	—	—	7830	7830	25900	30100	7230	256
1.2	1210	1.7	1105	3/V01L3	—	BN71A4	BE71A4	—	—	7830	7830	25900	28300	7230	266
1.2	1310	1.3	1198	3/V01L3	—	BN71A4	BE71A4	—	—	7920	7920	26200	28600	7420	266
1.2	1300	1.8	1189	3/V03L3	—	BN71A4	BE71A4	—	—	25600	29200	49300	58400	22200	276
1.2	1440	2.5	1152	3/V04L3	—	BN71A4	BE71A4	—	—	25500	29100	49100	58200	22000	288
1.3	1120	2.4	1023	3/V03L3	—	BN71A4	BE71A4	—	—	25000	28600	48300	57200	21100	276
1.4	1220	1.3	997	3/V01L3	—	BN71A4	BE71A4	—	—	7720	7720	25500	27900	6980	266
1.5	930	1.3	903	3/V01L3	—	BN71A4	BE71A4	—	—	7610	7610	25200	27500	6760	266
1.5	1110	2.4	923	3/V03L3	—	BN71A4	BE71A4	—	—	24700	28200	47600	56400	20400	276
1.6	1230	2.2	887	3/V04L3	—	BN71A4	BE71A4	—	—	24500	28000	47300	56000	20100	288
1.7	840	1.3	818	3/V00L3	—	BN71A4	BE71A4	—	—	7500	7500	24800	28900	6540	256
1.7	980	1.6	799	3/V01L3	—	BN71A4	BE71A4	—	—	7480	7480	24700	27000	6480	266
1.7	960	2.3	793	3/V03L3	—	BN71A4	BE71A4	—	—	24100	27600	46500	55100	19400	276
1.9	1180	1.5	731	—	3/A03L2	BN71A4	BE71A4	—	—	23900	27300	46000	54500	18900	277
1.9	980	2.7	710	3/V04L3	—	BN71A4	BE71A4	—	—	23700	27100	45800	54300	18700	288
2.0	800	1.4	689	3/V00L3	—	BN71A4	BE71A4	—	—	7320	7320	24200	28200	6170	256
2.0	800	2.1	689	3/V01L3	—	BN71A4	BE71A4	—	—	7320	7320	24200	26500	6170	266
2.1	1070	1.1	665	—	3/A01L2	BN71A4	BE71A4	M05C4	ME1SA4	7280	7280	24100	26300	6100	267
2.1	710	1.5	654	3/V00L3	—	BN71A4	BE71A4	—	—	7270	7270	24000	27900	6070	256
2.1	710	1.7	654	3/V01L3	—	BN71A4	BE71A4	—	—	7270	7270	24000	26300	6070	266
2.2	750	3.0	623	3/V03L3	—	BN71A4	BE71A4	—	—	23300	26600	45000	53300	17900	276
2.3	970	1.8	605	—	3/A03L2	BN71A4	BE71A4	—	—	23200	26500	44800	53100	17700	277
2.4	920	1.9	574	—	3/A03L2	BN71A4	BE71A4	—	—	23000	26300	44400	52700	17400	277
2.5	650	1.1	562	3/V00L3	—	BN71A4	BE71A4	—	—	7110	7110	23500	27300	5770	256
2.5	650	2.2	562	3/V01L3	—	BN71A4	BE71A4	—	—	7110	7110	23500	25700	5770	266
2.6	860	1.3	533	—	3/A01L2	BN71A4	BE71A4	M05C4	ME1SA4	7060	7060	23300	25500	5660	267
2.7	590	1.8	509	3/V00L3	—	BN71A4	BE71A4	—	—	7010	7010	23200	27000	5580	256
2.7	590	2.2	509	3/V01L3	—	BN71A4	BE71A4	—	—	7010	7010	23200	25300	5580	266
2.8	800	2.2	495	—	3/A03L2	BN71A4	BE71A4	—	—	22600	25800	43500	51600	16600	277
3.0	730	1.6	454	—	3/A01L2	BN71A4	BE71A4	M05C4	ME1SA4	6900	6900	22800	24900	5370	267
3.1	710	1.0	441	—	3/A00L2	BN71A4	BE71A4	M05C4	ME1SA4	6870	6870	22700	26400	5320	257
3.1	560	2.4	443	3/V01L3	—	BN71A4	BE71A4	—	—	6870	6870	22700	24800	5330	266
3.2	475	1.5	436	3/V00L3	—	BN71A4	BE71A4	—	—	6860	6860	22700	26400	5300	256
3.3	480	2.1	415	3/V00L3	—	BN71A4	BE71A4	—	—	6810	6810	22500	26200	5210	256
3.4	660	2.9	409	—	3/A03L2	BN71A4	BE71A4	—	—	22000	25100	42300	50200	15600	277
3.5	630	1.3	393	—	3/A01L2	BN71A4	BE71A4	M05C4	ME1SA4	6760	6760	22300	24400	5120	267
3.7	590	0.9	369	—	3/A00L2	BN71A4	BE71A4	M05C4	ME1SA4	6700	6700	22100	25800	5010	257
3.8	590	2.3	364	—	3/A01L2	BN71A4	BE71A4	M05C4	ME1SA4	6680	6680	22100	24200	4990	267
4.4	500	2.3	311	—	3/A01L2	BN71A4	BE71A4	M05C4	ME1SA4	6530	6530	21600	23600	4740	267
4.7	475	1.4	296	—	3/A00L2	BN71A4	BE71A4	M05C4	ME1SA4	6500	6500	21500	25000	4660	257
5.1	435	2.3	269	—	3/A01L2	BN71A4	BE71A4	M05C4	ME1SA4	6500	6500	21500	23500	4510	267
5.4	410	2.8	255	—	3/A01L2	BN71A4	BE71A4	M05C4	ME1SA4	6500	6500	21500	23500	4430	267
5.5	410	1.3	253	—	3/A00L2	BN71A4	BE71A4	M05C4	ME1SA4	6500	6500	21500	25000	4420	257
6.3	355	1.8	219	—	3/A00L2	BN71A4	BE71A4	M05C4	ME1SA4	6500	6500	21500	25000	4210	257
6.3	355	2.3	220	—	3/A01L2	BN71A4	BE71A4	M05C4	ME1SA4	6500	6500	21500	23500	4220	267
6.8	325	2.0	203	—	3/A00L2	BN71A4	BE71A4	M05C4	ME1SA4	6500	6500	21500	25000	4100	257
8.1	275	2.0	171	—	3/A00L2	BN71A4	BE71A4	M05C4	ME1SA4	6500	6500	21500	25000	3880	257
10.3	215	2.5	134	—	3/A00L2	BN71A4	BE71A4	M05C4	ME1SA4	6260	6260	20800	24200	3580	257

$P_1 = 0.25 \text{ kW}$

n_2 min ⁻¹	M_2 Nm	S	i	[Image]		IE3		R _{n2} [N]					[Icon]		
				[Image]	[Image]	[Image]	[Image]	MC/PC	MZ/PZ	HC	HZ	FZ			
0.53	3080	2.3	2588	3/V06L3	—	BXN71MA4	—	—	—	34000	38800	77500	89500	35000	312
0.58	2770	1.1	2366	3/V04L3	—	BXN71MA4	—	—	—	28200	32200	54400	64500	24000	288
0.62	2620	1.7	2232	3/V05L3	—	BXN71MA4	—	—	—	28000	32000	53900	63900	24000	300
0.69	2190	1.1	2009	3/V03L3	—	BXN71MA4	—	—	—	27600	31500	53100	63000	24000	276
0.73	2220	1.4	1893	3/V04L3	—	BXN71MA4	—	—	—	27300	31200	52700	62400	24000	288
0.77	2090	2.2	1786	3/V05L3	—	BXN71MA4	—	—	—	27100	31000	52300	61900	24000	300
0.78	2220	1.3	1774	3/V04L3	—	BXN71MA4	—	—	—	27100	30900	52200	61900	24000	288
0.80	1880	1.5	1728	3/V03L3	—	BXN71MA4	—	—	—	27000	30800	52000	61600	24000	276
0.82	2100	2.1	1674	3/V05L3	—	BXN71MA4	—	—	—	26800	30700	51800	61400	24000	300
0.86	1760	1.4	1610	3/V03L3	—	BXN71MA4	—	—	—	26700	30500	51500	61000	24000	276
0.90	1800	2.1	1536	3/V04L3	—	BXN71MA4	—	—	—	26500	30300	51100	60600	24000	288
0.92	1630	1.1	1495	3/V01L3	—	BXN71MA4	—	—	—	8180	8180	27000	29600	7990	266

A

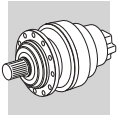

$P_1 = 0.25 \text{ kW}$

n_2 min ⁻¹	M_2 Nm	S	i					Rn ₂ [N]					
				IE3	IE3	MC/PC	MZ/PZ	HC	HZ	FZ			
0.96	1680	2.8	1431	3/V05L3	—	BXN71MA4	—	26300	30000	50600	60000	23600	300
0.97	1780	1.7	1419	3/V04L3	—	BXN71MA4	—	26200	30000	50600	59900	23600	288
1.0	1420	1.3	1381	3/V01L3	—	BXN71MA4	—	8080	8080	26700	29200	7780	266
1.0	1510	1.9	1385	3/V03L3	—	BXN71MA4	—	26100	29900	50400	59700	23400	276
1.1	1440	2.5	1231	3/V04L3	—	BXN71MA4	—	25700	29400	49500	58700	22500	288
1.2	1140	1.0	1107	3/V00L3	—	BXN71MA4	—	7830	7830	25900	30100	7230	256
1.2	1210	1.7	1105	3/V01L3	—	BXN71MA4	—	7830	7830	25900	28300	7230	266
1.2	1310	1.3	1198	3/V01L3	—	BXN71MA4	—	7920	7920	26200	28600	7420	266
1.2	1300	1.8	1189	3/V03L3	—	BXN71MA4	—	25600	29200	49300	58400	22200	276
1.2	1440	2.5	1152	3/V04L3	—	BXN71MA4	—	25500	29100	49100	58200	22000	288
1.3	1120	2.4	1023	3/V03L3	—	BXN71MA4	—	25000	28600	48300	57200	21100	276
1.4	1220	1.3	997	3/V01L3	—	BXN71MA4	—	7720	7720	25500	27900	6980	266
1.5	930	1.3	903	3/V01L3	—	BXN71MA4	—	7610	7610	25200	27500	6760	266
1.5	1110	2.4	923	3/V03L3	—	BXN71MA4	—	24700	28200	47600	56400	20400	276
1.6	1230	2.2	887	3/V04L3	—	BXN71MA4	—	24500	28000	47300	56000	20100	288
1.7	840	1.3	818	3/V00L3	—	BXN71MA4	—	7500	7500	24800	28900	6540	256
1.7	980	1.6	799	3/V01L3	—	BXN71MA4	—	7480	7480	24700	27000	6480	266
1.7	960	2.3	793	3/V03L3	—	BXN71MA4	—	24100	27600	46500	55100	19400	276
1.9	1180	1.5	731	—	3/A03L2	BXN71MA4	—	23900	27300	46000	54500	18900	277
1.9	980	2.7	710	3/V04L3	—	BXN71MA4	—	23700	27100	45800	54300	18700	288
2.0	800	1.4	689	3/V00L3	—	BXN71MA4	—	7320	7320	24200	28200	6170	256
2.0	800	2.1	689	3/V01L3	—	BXN71MA4	—	7320	7320	24200	26500	6170	266
2.1	1070	1.1	665	—	3/A01L2	BXN71MA4	MXN10MA4	7280	7280	24100	26300	6100	267
2.1	710	1.5	654	3/V00L3	—	BXN71MA4	—	7270	7270	24000	27900	6070	256
2.1	710	1.7	654	3/V01L3	—	BXN71MA4	—	7270	7270	24000	26300	6070	266
2.2	750	3.0	623	3/V03L3	—	BXN71MA4	—	23300	26600	45000	53300	17900	276
2.3	970	1.8	605	—	3/A03L2	BXN71MA4	—	23200	26500	44800	53100	17700	277
2.4	920	1.9	574	—	3/A03L2	BXN71MA4	—	23000	26300	44400	52700	17400	277
2.5	650	1.1	562	3/V00L3	—	BXN71MA4	—	7110	7110	23500	27300	5770	256
2.5	650	2.2	562	3/V01L3	—	BXN71MA4	—	7110	7110	23500	25700	5770	266
2.6	860	1.3	533	—	3/A01L2	BXN71MA4	MXN10MA4	7060	7060	23300	25500	5660	267
2.7	590	1.8	509	3/V00L3	—	BXN71MA4	—	7010	7010	23200	27000	5580	256
2.7	590	2.2	509	3/V01L3	—	BXN71MA4	—	7010	7010	23200	25300	5580	266
2.8	800	2.2	495	—	3/A03L2	BXN71MA4	—	22600	25800	43500	51600	16600	277
3.0	730	1.6	454	—	3/A01L2	BXN71MA4	MXN10MA4	6900	6900	22800	24900	5370	267
3.1	710	1.0	441	—	3/A00L2	BXN71MA4	MXN10MA4	6870	6870	22700	26400	5320	257
3.1	560	2.4	443	3/V01L3	—	BXN71MA4	—	6870	6870	22700	24800	5330	266
3.2	475	1.5	436	3/V00L3	—	BXN71MA4	—	6860	6860	22700	26400	5300	256
3.3	480	2.1	415	3/V00L3	—	BXN71MA4	—	6810	6810	22500	26200	5210	256
3.4	660	2.9	409	—	3/A03L2	BXN71MA4	—	22000	25100	42300	50200	15600	277
3.5	630	1.3	393	—	3/A01L2	BXN71MA4	MXN10MA4	6760	6760	22300	24400	5120	267
3.7	590	0.9	369	—	3/A00L2	BXN71MA4	MXN10MA4	6700	6700	22100	25800	5010	257
3.8	590	2.3	364	—	3/A01L2	BXN71MA4	MXN10MA4	6680	6680	22100	24200	4990	267
4.4	500	2.3	311	—	3/A01L2	BXN71MA4	MXN10MA4	6530	6530	21600	23600	4740	267
4.7	475	1.4	296	—	3/A00L2	BXN71MA4	MXN10MA4	6500	6500	21500	25000	4660	257
5.1	435	2.3	269	—	3/A01L2	BXN71MA4	MXN10MA4	6500	6500	21500	23500	4510	267
5.4	410	2.8	255	—	3/A01L2	BXN71MA4	MXN10MA4	6500	6500	21500	23500	4430	267
5.5	410	1.3	253	—	3/A00L2	BXN71MA4	MXN10MA4	6500	6500	21500	25000	4420	257
6.3	355	1.8	219	—	3/A00L2	BXN71MA4	MXN10MA4	6500	6500	21500	25000	4210	257
6.3	355	2.3	220	—	3/A01L2	BXN71MA4	MXN10MA4	6500	6500	21500	23500	4220	267
6.8	325	2.0	203	—	3/A00L2	BXN71MA4	MXN10MA4	6500	6500	21500	25000	4100	257
8.1	275	2.0	171	—	3/A00L2	BXN71MA4	MXN10MA4	6500	6500	21500	25000	3880	257
10.3	215	2.5	134	—	3/A00L2	BXN71MA4	MXN10MA4	6260	6260	20800	24200	3580	257

$P_1 = 0.37 \text{ kW}$

n_2 min ⁻¹	M_2 Nm	S	i							Rn ₂ [N]					
				IE1	IE2	IE1	IE2	MC/PC	MZ/PZ	HC	HZ	FZ			
0.53	4620	1.5	2588	3/V06L3	—	BN71B4	BE71B4	M1SD4	ME1SB4	34000	38800	77500	89500	35000	312
0.61	3930	1.1	2232	3/V05L3	—	BN71B4	BE71B4	M1SD4	ME1SB4	28000	32000	53900	63900	24000	300
0.64	3820	2.2	2139	3/V06L3	—	BN71B4	BE71B4	M1SD4	ME1SB4	33100	37700	75500	87100	35000	312
0.77	3150	1.5	1786	3/V05L3	—	BN71B4	BE71B4	M1SD4	ME1SB4	27100	31000	52300	61900	24000	300
0.77	3160	2.7	1768	3/V06L3	—	BN71B4	BE71B4	M1SD4	ME1SB4	32200	36700	73400	84800	35000	312
0.79	2830	1.0	1728	3/V03L3	—	BN71B4	BE71B4	M1SD4	ME1SB4	27000	30800	52000	61600	24000	276
0.82	3150	1.4	1674	3/V05L3	—	BN71B4	BE71B4	M1SD4	ME1SB4	26800	30700	51800	61400	24000	300

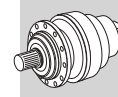

$P_1 = 0.37 \text{ kW}$

n ₂ min ⁻¹	M ₂ Nm	S	i	[Image]		[Image]		[Image]		Rn ₂ [N]					[Icon]
				IE1	IE2	IE1	IE2	MC/PC	MZ/PZ	HC	HZ	FZ			
0.85	2640	0.9	1610	3/V03L3	—	BN71B4	BE71B4	M1SD4	ME1SB4	26700	30500	51500	61000	24000	276
0.89	2710	1.4	1536	3/V04L3	—	BN71B4	BE71B4	M1SD4	ME1SB4	26500	30300	51100	60600	24000	288
0.96	2520	1.8	1431	3/V05L3	—	BN71B4	BE71B4	M1SD4	ME1SB4	26300	30000	50600	60000	23600	300
0.97	2670	1.1	1419	3/V04L3	—	BN71B4	BE71B4	M1SD4	ME1SB4	26200	30000	50600	59900	23600	288
0.99	2270	1.2	1385	3/V03L3	—	BN71B4	BE71B4	M1SD4	ME1SB4	26100	29900	50400	59700	23400	276
1.1	2170	1.7	1231	3/V04L3	—	BN71B4	BE71B4	M1SD4	ME1SB4	25700	29400	49500	58700	22500	288
1.1	2170	2.5	1231	3/V05L3	—	BN71B4	BE71B4	M1SD4	ME1SB4	25700	29400	49500	58700	22500	300
1.2	1810	1.1	1105	3/V01L3	—	BN71B4	BE71B4	—	—	7830	7830	25900	28300	7230	266
1.2	1950	1.2	1189	3/V03L3	—	BN71B4	BE71B4	M1SD4	ME1SB4	25600	29200	49300	58400	22200	276
1.2	2170	1.6	1152	3/V04L3	—	BN71B4	BE71B4	M1SD4	ME1SB4	25500	29100	49100	58200	22000	288
1.2	2180	2.0	1116	3/V05L3	—	BN71B4	BE71B4	M1SD4	ME1SB4	25300	29000	48900	57900	21700	300
1.3	1680	1.6	1023	3/V03L3	—	BN71B4	BE71B4	M1SD4	ME1SB4	25000	28600	48300	57200	21100	276
1.3	1860	2.4	1057	3/V05L3	—	BN71B4	BE71B4	M1SD4	ME1SB4	25100	28700	48500	57500	21400	300
1.4	1730	2.2	981	3/V04L3	—	BN71B4	BE71B4	M1SD4	ME1SB4	24900	28400	48000	56900	20800	288
1.5	1670	1.6	923	3/V03L3	—	BN71B4	BE71B4	M1SD4	ME1SB4	24700	28200	47600	56400	20400	276
1.5	1840	1.5	887	3/V04L3	—	BN71B4	BE71B4	M1SD4	ME1SB4	24500	28000	47300	56000	20100	288
1.5	1750	2.5	894	3/V05L3	—	BN71B4	BE71B4	M1SD4	ME1SB4	24500	28100	47300	56100	20200	300
1.7	1470	1.1	799	3/V01L3	—	BN71B4	BE71B4	—	—	7480	7480	24700	27000	6480	266
1.7	1440	1.5	793	3/V03L3	—	BN71B4	BE71B4	M1SD4	ME1SB4	24100	27600	46500	55100	19400	276
1.7	1490	2.8	793	3/V05L3	—	BN71B4	BE71B4	M1SD4	ME1SB4	24100	27600	46500	55100	19400	300
1.8	1500	2.2	769	3/V04L3	—	BN71B4	BE71B4	M1SD4	ME1SB4	24000	27500	46300	54900	19200	288
1.9	1770	1.0	731	—	3/A03L2	BN71B4	BE71B4	—	—	23900	27300	46000	54500	18900	277
1.9	1330	2.0	736	3/V03L3	—	BN71B4	BE71B4	M1SD4	ME1SB4	23900	27300	46000	54600	18900	276
1.9	1480	1.8	710	3/V04L3	—	BN71B4	BE71B4	M1SD4	ME1SB4	23700	27100	45800	54300	18700	288
1.9	1450	2.8	715	3/V05L3	—	BN71B4	BE71B4	M1SD4	ME1SB4	23800	27200	45900	54300	18800	300
2.0	1200	0.9	689	3/V00L3	—	BN71B4	BE71B4	—	—	7320	7320	24200	28200	6170	256
2.0	1200	1.4	689	3/V01L3	—	BN71B4	BE71B4	—	—	7320	7320	24200	26500	6170	266
2.1	1070	1.0	654	3/V00L3	—	BN71B4	BE71B4	—	—	7270	7270	24000	27900	6070	256
2.1	1070	1.1	654	3/V01L3	—	BN71B4	BE71B4	—	—	7270	7270	24000	26300	6070	266
2.2	1130	2.0	623	3/V03L3	—	BN71B4	BE71B4	M1SD4	ME1SB4	23300	26600	45000	53300	17900	276
2.3	1460	1.2	605	—	3/A03L2	BN71B4	BE71B4	—	—	23200	26500	44800	53100	17700	277
2.3	1440	2.3	594	—	3/A05L2	BN71B4	BE71B4	M1SD4	ME1SB4	23200	26500	44700	52900	17600	301
2.4	1390	1.3	574	—	3/A03L2	BN71B4	BE71B4	M1SD4	ME1SB4	23000	26300	44400	52700	17400	277
2.4	980	1.4	562	3/V01L3	—	BN71B4	BE71B4	—	—	7110	7110	23500	25700	5770	266
2.4	1110	2.8	568	3/V04L3	—	BN71B4	BE71B4	M1SD4	ME1SB4	23000	26300	44400	52600	17400	288
2.5	980	2.8	544	3/V03L3	—	BN71B4	BE71B4	M1SD4	ME1SB4	22900	26100	44100	52300	17100	276
2.6	1260	2.0	520	—	3/A04L2	BN71B4	BE71B4	M1SD4	ME1SB4	22700	26000	43800	51900	16900	289
2.7	880	1.2	509	3/V00L3	—	BN71B4	BE71B4	—	—	7010	7010	23200	27000	5580	256
2.7	880	1.4	509	3/V01L3	—	BN71B4	BE71B4	—	—	7010	7010	23200	25300	5580	266
2.7	990	2.0	502	3/V03L3	—	BN71B4	BE71B4	M1SD4	ME1SB4	22600	25800	43600	51700	16700	276
2.8	1200	1.4	495	—	3/A03L2	BN71B4	BE71B4	M1SD4	ME1SB4	22600	25800	43500	51600	16600	277
2.9	1140	2.2	469	—	3/A04L2	BN71B4	BE71B4	M1SD4	ME1SB4	22400	25600	43200	51200	16300	289
3.0	1100	1.0	454	—	3/A01L2	BN71B4	BE71B4	M1SD4	ME1SB4	6900	6900	22800	24900	5370	267
3.0	830	2.8	460	3/V03L3	—	BN71B4	BE71B4	M1SD4	ME1SB4	22300	25500	43100	51000	16200	276
3.1	710	1.0	436	3/V00L3	—	BN71B4	BE71B4	—	—	6860	6860	22700	26400	5300	256
3.1	850	1.6	443	3/V01L3	—	BN71B4	BE71B4	—	—	6870	6870	22700	24800	5330	266
3.2	850	2.2	430	3/V01L3	—	BN71B4	BE71B4	—	—	6840	6840	22600	24700	5270	266
3.3	990	2.0	409	—	3/A03L2	BN71B4	BE71B4	M1SD4	ME1SB4	22000	25100	42300	50200	15600	277
3.3	720	1.4	415	3/V00L3	—	BN71B4	BE71B4	—	—	6810	6810	22500	26200	5210	256
3.5	930	2.6	386	—	3/A04L2	BN71B4	BE71B4	M1SD4	ME1SB4	21800	24900	42000	49800	15300	289
3.5	780	2.8	395	3/V03L3	—	BN71B4	BE71B4	M1SD4	ME1SB4	21800	25000	42100	49900	15400	276
3.8	880	1.5	364	—	3/A01L2	BN71B4	BE71B4	M1SD4	ME1SB4	6680	6680	22100	24200	4990	267
3.9	850	2.4	352	—	3/A03L2	BN71B4	BE71B4	M1SD4	ME1SB4	21500	24600	41400	49100	14800	277
3.9	840	2.9	349	—	3/A04L2	BN71B4	BE71B4	M1SD4	ME1SB4	21500	24500	41400	49000	14800	289
4.2	790	2.1	326	—	3/A03L2	BN71B4	BE71B4	M1SD4	ME1SB4	21200	24300	41000	48600	14400	277
4.4	750	1.5	311	—	3/A01L2	BN71B4	BE71B4	M1SD4	ME1SB4	6530	6530	21600	23600	4740	267
4.6	720	0.9	296	—	3/A00L2	BN71B4	BE71B4	M1SD4	ME1SB4	6500	6500	21500	25000	4660	257
5.1	650	1.6	269	—	3/A01L2	BN71B4	BE71B4	M1SD4	ME1SB4	6500	6500	21500	23500	4510	267
5.1	650	2.8	269	—	3/A03L2	BN71B4	BE71B4	M1SD4	ME1SB4	21000	24000	40500	48000	13500	277
5.1	650	2.8	269	—	3/A03L2	BN71B4	BE71B4	M1SD4	ME1SB4	21000	24000	40500	48000	13500	277
5.4	620	1.9	255	—	3/A01L2	BN71B4	BE71B4	M1SD4	ME1SB4	6500	6500	21500	23500	4430	267
6.2	530	1.6	220	—	3/A01L2	BN71B4	BE71B4	M1SD4	ME1SB4	6500	6500	21500	23500	4220	267
6.3	530	1.2	219	—	3/A00L2	BN71B4	BE71B4	M1SD4	ME1SB4	6500	6500	21500	25000	4210	257
6.7	490	1.3	203	—	3/A00L2	BN71B4	BE71B4	M1SD4	ME1SB4	6500	6500	21500	25000	4100	257
6.7	495	2.6	204	—	3/A01L2	BN71B4	BE71B4	M1SD4	ME1SB4	6500	6500	21500	23500	4120	267
7.4	445	2.3	184	—	3/A01L2	BN71B4	BE71B4	M1SD4	ME1SB4	6500	6500	21500	23500	3980	267
8.0	415	1.3	171	—	3/A00L2	BN71B4	BE71B4	M1SD4	ME1SB4	6500	6500	21500	25000	3880	257
8.3	400	2.9	166	—	3/A01L2	BN71B4	BE71B4	M1SD4	ME1SB4	6500	6500	21500	23500	3840	267

A

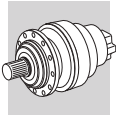

$P_1 = 0.37 \text{ kW}$

n_2 min ⁻¹	M_2 Nm	S	i	3/A00L2		IE1 IE2		IE1 IE2		Rn ₂ [N]					
								MC/PC	MZ/PZ	HC	HZ	FZ			
10.2	325	1.7	134	—	3/A00L2	BN71B4	BE71B4	M1SD4	ME1SB4	6260	6260	20800	24200	3580	257
12.8	260	2.5	107	—	3/A00L2	BN71B4	BE71B4	M1SD4	ME1SB4	5810	5810	19400	22600	3320	257
13.7	240	2.3	100	—	3/A00L2	BN71B4	BE71B4	M1SD4	ME1SB4	5680	5680	19000	22100	3240	257
15.5	215	2.6	88.6	—	3/A00L2	BN71B4	BE71B4	M1SD4	ME1SB4	5450	5450	18400	21300	3120	257

$P_1 = 0.37 \text{ kW}$

n_2 min ⁻¹	M_2 Nm	S	i	3/V06L3		IE3		IE3		Rn ₂ [N]					
								MC/PC	MZ/PZ	HC	HZ	FZ			
0.53	4620	1.5	2588	3/V06L3	—	BXN71MB4	MXN10MB4	34000	38800	77500	89500	35000	312		
0.61	3930	1.1	2232	3/V05L3	—	BXN71MB4	MXN10MB4	28000	32000	53900	63900	24000	300		
0.64	3820	2.2	2139	3/V06L3	—	BXN71MB4	MXN10MB4	33100	37700	75500	87100	35000	312		
0.77	3150	1.5	1786	3/V05L3	—	BXN71MB4	MXN10MB4	27100	31000	52300	61900	24000	300		
0.77	3160	2.7	1768	3/V06L3	—	BXN71MB4	MXN10MB4	32200	36700	73400	84800	35000	312		
0.79	2830	1.0	1728	3/V03L3	—	BXN71MB4	MXN10MB4	27000	30800	52000	61600	24000	276		
0.82	3150	1.4	1674	3/V05L3	—	BXN71MB4	MXN10MB4	26800	30700	51800	61400	24000	300		
0.85	2640	0.9	1610	3/V03L3	—	BXN71MB4	MXN10MB4	26700	30500	51500	61000	24000	276		
0.89	2710	1.4	1536	3/V04L3	—	BXN71MB4	MXN10MB4	26500	30300	51100	60600	24000	288		
0.96	2520	1.8	1431	3/V05L3	—	BXN71MB4	MXN10MB4	26300	30000	50600	60000	23600	300		
0.97	2670	1.1	1419	3/V04L3	—	BXN71MB4	MXN10MB4	26200	30000	50600	59900	23600	288		
0.99	2270	1.2	1385	3/V03L3	—	BXN71MB4	MXN10MB4	26100	29900	50400	59700	23400	276		
1.1	2170	1.7	1231	3/V04L3	—	BXN71MB4	MXN10MB4	25700	29400	49500	58700	22500	288		
1.1	2170	2.5	1231	3/V05L3	—	BXN71MB4	MXN10MB4	25700	29400	49500	58700	22500	300		
1.2	1810	1.1	1105	3/V01L3	—	BXN71MB4	—	7830	7830	25900	28300	7230	266		
1.2	1950	1.2	1189	3/V03L3	—	BXN71MB4	MXN10MB4	25600	29200	49300	58400	22200	276		
1.2	2170	1.6	1152	3/V04L3	—	BXN71MB4	MXN10MB4	25500	29100	49100	58200	22000	288		
1.2	2180	2.0	1116	3/V05L3	—	BXN71MB4	MXN10MB4	25300	29000	48900	57900	21700	300		
1.3	1680	1.6	1023	3/V03L3	—	BXN71MB4	MXN10MB4	25000	28600	48300	57200	21100	276		
1.3	1860	2.4	1057	3/V05L3	—	BXN71MB4	MXN10MB4	25100	28700	48500	57500	21400	300		
1.4	1730	2.2	981	3/V04L3	—	BXN71MB4	MXN10MB4	24900	28400	48000	56900	20800	288		
1.5	1670	1.6	923	3/V03L3	—	BXN71MB4	MXN10MB4	24700	28200	47600	56400	20400	276		
1.5	1840	1.5	887	3/V04L3	—	BXN71MB4	MXN10MB4	24500	28000	47300	56000	20100	288		
1.5	1750	2.5	894	3/V05L3	—	BXN71MB4	MXN10MB4	24500	28100	47300	56100	20200	300		
1.7	1470	1.1	799	3/V01L3	—	BXN71MB4	—	7480	7480	24700	27000	6480	266		
1.7	1440	1.5	793	3/V03L3	—	BXN71MB4	MXN10MB4	24100	27600	46500	55100	19400	276		
1.7	1490	2.8	793	3/V05L3	—	BXN71MB4	MXN10MB4	24100	27600	46500	55100	19400	300		
1.8	1500	2.2	769	3/V04L3	—	BXN71MB4	MXN10MB4	24000	27500	46300	54900	19200	288		
1.9	1770	1.0	731	—	3/A03L2	BXN71MB4	—	23900	27300	46000	54500	18900	277		
1.9	1330	2.0	736	3/V03L3	—	BXN71MB4	MXN10MB4	23900	27300	46000	54600	18900	276		
1.9	1480	1.8	710	3/V04L3	—	BXN71MB4	MXN10MB4	23700	27100	45800	54300	18700	288		
1.9	1450	2.8	715	3/V05L3	—	BXN71MB4	MXN10MB4	23800	27200	45900	54300	18800	300		
2.0	1200	0.9	689	3/V00L3	—	BXN71MB4	—	7320	7320	24200	28200	6170	256		
2.0	1200	1.4	689	3/V01L3	—	BXN71MB4	—	7320	7320	24200	26500	6170	266		
2.1	1070	1.0	654	3/V00L3	—	BXN71MB4	—	7270	7270	24000	27900	6070	256		
2.1	1070	1.1	654	3/V01L3	—	BXN71MB4	—	7270	7270	24000	26300	6070	266		
2.2	1130	2.0	623	3/V03L3	—	BXN71MB4	MXN10MB4	23300	26600	45000	53300	17900	276		
2.3	1460	1.2	605	—	3/A03L2	BXN71MB4	—	23200	26500	44800	53100	17700	277		
2.3	1440	2.3	594	—	3/A05L2	BXN71MB4	—	23200	26500	44700	52900	17600	301		
2.4	1390	1.3	574	—	3/A03L2	BXN71MB4	MXN10MB4	23000	26300	44400	52700	17400	277		
2.4	980	1.4	562	3/V01L3	—	BXN71MB4	—	7110	7110	23500	25700	5770	266		
2.4	1110	2.8	568	3/V04L3	—	BXN71MB4	MXN10MB4	23000	26300	44400	52600	17400	288		
2.5	980	2.8	544	3/V03L3	—	BXN71MB4	MXN10MB4	22900	26100	44100	52300	17100	276		
2.6	1260	2.0	520	—	3/A04L2	BXN71MB4	—	22700	26000	43800	51900	16900	289		
2.7	880	1.2	509	3/V00L3	—	BXN71MB4	—	7010	7010	23200	27000	5580	256		
2.7	880	1.4	509	3/V01L3	—	BXN71MB4	—	7010	7010	23200	25300	5580	266		
2.7	990	2.0	502	3/V03L3	—	BXN71MB4	MXN10MB4	22600	25800	43600	51700	16700	276		
2.8	1200	1.4	495	—	3/A03L2	BXN71MB4	MXN10MB4	22600	25800	43500	51600	16600	277		
2.9	1140	2.2	469	—	3/A04L2	BXN71MB4	—	22400	25600	43200	51200	16300	289		
3.0	1100	1.0	454	—	3/A01L2	BXN71MB4	MXN10MB4	6900	6900	22800	24900	5370	267		
3.0	830	2.8	460	3/V03L3	—	BXN71MB4	MXN10MB4	22300	25500	43100	51000	16200	276		
3.1	710	1.0	436	3/V00L3	—	BXN71MB4	—	6860	6860	22700	26400	5300	256		
3.1	850	1.6	443	3/V01L3	—	BXN71MB4	—	6870	6870	22700	24800	5330	266		
3.2	850	2.2	430	3/V01L3	—	BXN71MB4	—	6840	6840	22600	24700	5270	266		
3.3	990	2.0	409	—	3/A03L2	BXN71MB4	MXN10MB4	22000	25100	42300	50200	15600	277		
3.3	720	1.4	415	3/V00L3	—	BXN71MB4	—	6810	6810	22500	26200	5210	256		

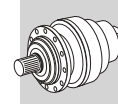

$P_1 = 0.37 \text{ kW}$

n_2 min ⁻¹	M_2 Nm	S	i					R_{n_2} [N]					
				IE3	IE3	MC/PC	MZ/PZ	HC	HZ	FZ			
3.5	930	2.6	386	—	3/A04L2	BXN71MB4	—	21800	24900	42000	49800	15300	289
3.5	780	2.8	395	3/V03L3	—	BXN71MB4	MXN10MB4	21800	25000	42100	49900	15400	276
3.8	880	1.5	364	—	3/A01L2	BXN71MB4	MXN10MB4	6680	6680	22100	24200	4990	267
3.9	850	2.4	352	—	3/A03L2	BXN71MB4	MXN10MB4	21500	24600	41400	49100	14800	277
3.9	840	2.9	349	—	3/A04L2	BXN71MB4	—	21500	24500	41400	49000	14800	289
4.2	790	2.1	326	—	3/A03L2	BXN71MB4	MXN10MB4	21200	24300	41000	48600	14400	277
4.4	750	1.5	311	—	3/A01L2	BXN71MB4	MXN10MB4	6530	6530	21600	23600	4740	267
4.6	720	0.9	296	—	3/A00L2	BXN71MB4	MXN10MB4	6500	6500	21500	25000	4660	257
5.1	650	1.6	269	—	3/A01L2	BXN71MB4	MXN10MB4	6500	6500	21500	23500	4510	267
5.1	650	2.8	269	—	3/A03L2	BXN71MB4	MXN10MB4	21000	24000	40500	48000	13500	277
5.1	650	2.8	269	—	3/A03L2	BXN71MB4	MXN10MB4	21000	24000	40500	48000	13500	277
5.4	620	1.9	255	—	3/A01L2	BXN71MB4	MXN10MB4	6500	6500	21500	23500	4430	267
6.2	530	1.6	220	—	3/A01L2	BXN71MB4	MXN10MB4	6500	6500	21500	23500	4220	267
6.3	530	1.2	219	—	3/A00L2	BXN71MB4	MXN10MB4	6500	6500	21500	25000	4210	257
6.7	490	1.3	203	—	3/A00L2	BXN71MB4	MXN10MB4	6500	6500	21500	25000	4100	257
6.7	495	2.6	204	—	3/A01L2	BXN71MB4	MXN10MB4	6500	6500	21500	23500	4120	267
7.4	445	2.3	184	—	3/A01L2	BXN71MB4	MXN10MB4	6500	6500	21500	23500	3980	267
8.0	415	1.3	171	—	3/A00L2	BXN71MB4	MXN10MB4	6500	6500	21500	25000	3880	257
8.3	400	2.9	166	—	3/A01L2	BXN71MB4	MXN10MB4	6500	6500	21500	23500	3840	267
10.2	325	1.7	134	—	3/A00L2	BXN71MB4	MXN10MB4	6260	6260	20800	24200	3580	257
12.8	260	2.5	107	—	3/A00L2	BXN71MB4	MXN10MB4	5810	5810	19400	22600	3320	257
13.7	240	2.3	100	—	3/A00L2	BXN71MB4	MXN10MB4	5680	5680	19000	22100	3240	257
15.5	215	2.6	88.6	—	3/A00L2	BXN71MB4	MXN10MB4	5450	5450	18400	21300	3120	257

$P_1 = 0.55 \text{ kW}$

n_2 min ⁻¹	M_2 Nm	S	i					R_{n_2} [N]							
				IE1	IE2	IE1	IE2	MC/PC	MZ/PZ	HC	HZ	FZ			
0.28	12600	2.2	4959	3/V10ML4	—	BN80A4	BE80A4	M1LA4	ME2SA4	—	—	116400	147600	65000	348
0.28	12600	2.2	4959	3/V10ML4	—	BN80A4	BE80A4	M1LA4	ME2SA4	—	—	116400	147600	65000	348
0.30	11700	2.6	4637	3/V10ML4	—	BN80A4	BE80A4	M1LA4	ME2SA4	—	—	115300	146200	65000	348
0.30	11700	2.6	4637	3/V10ML4	—	BN80A4	BE80A4	M1LA4	ME2SA4	—	—	115300	146200	65000	348
0.34	11800	2.6	4036	3/V10ML4	—	BN80A4	BE80A4	M1LA4	ME2SA4	—	—	113100	143400	65000	348
0.34	11800	2.6	4036	3/V10ML4	—	BN80A4	BE80A4	M1LA4	ME2SA4	—	—	113100	143400	65000	348
0.42	9540	2.9	3273	3/V10ML4	—	BN80A4	BE80A4	M1LA4	ME2SA4	—	—	109700	139100	65000	348
0.42	9540	2.9	3273	3/V10ML4	—	BN80A4	BE80A4	M1LA4	ME2SA4	—	—	109700	139100	65000	348
0.54	6750	1.0	2588	3/V06L3	—	BN80A4	BE80A4	M1LA4	ME2SA4	34000	38800	77500	89500	35000	312
0.56	6190	1.8	2472	3/V07L3	—	BN80A4	BE80A4	—	—	40500	50700	91200	120000	45000	324
0.65	5580	1.5	2139	3/V06L3	—	BN80A4	BE80A4	M1LA4	ME2SA4	33100	37700	75500	87100	35000	312
0.65	5690	1.9	2150	3/V07L3	—	BN80A4	BE80A4	—	—	39700	49700	89400	117600	45000	324
0.71	4920	2.5	1964	3/V07L3	—	BN80A4	BE80A4	—	—	39200	49000	88300	116100	45000	324
0.78	4600	1.0	1786	3/V05L3	—	BN80A4	BE80A4	M1LA4	ME2SA4	27100	31000	52300	61900	24000	300
0.79	4610	1.9	1768	3/V06L3	—	BN80A4	BE80A4	M1LA4	ME2SA4	32200	36700	73400	84800	35000	312
0.83	4610	1.0	1674	3/V05L3	—	BN80A4	BE80A4	M1LA4	ME2SA4	26800	30700	51800	61400	24000	300
0.90	3950	0.9	1536	3/V04L3	—	BN80A4	BE80A4	M1LA4	ME2SA4	26500	30300	51100	60600	24000	288
0.90	4200	2.6	1545	3/V07L3	—	BN80A4	BE80A4	—	—	37900	47400	85300	112200	45000	324
0.97	3680	1.3	1431	3/V05L3	—	BN80A4	BE80A4	M1LA4	ME2SA4	26300	30000	50600	60000	23600	300
1.0	3790	2.2	1395	3/V06L3	—	BN80A4	BE80A4	M1LA4	ME2SA4	31100	35500	71000	82000	34200	312
1.1	3170	1.1	1231	3/V04L3	—	BN80A4	BE80A4	M1LA4	ME2SA4	25700	29400	49500	58700	22500	288
1.1	3170	1.7	1231	3/V05L3	—	BN80A4	BE80A4	M1LA4	ME2SA4	25700	29400	49500	58700	22500	300
1.1	3160	2.5	1212	3/V06L3	—	BN80A4	BE80A4	M1LA4	ME2SA4	30500	34800	69600	80300	32600	312
1.2	3170	1.1	1152	3/V04L3	—	BN80A4	BE80A4	M1LA4	ME2SA4	25500	29100	49100	58200	22000	288
1.2	3190	1.4	1116	3/V05L3	—	BN80A4	BE80A4	M1LA4	ME2SA4	25300	29000	48900	57900	21700	300
1.2	3130	2.6	1153	3/V06L3	—	BN80A4	BE80A4	M1LA4	ME2SA4	30300	34500	69100	79800	32100	312
1.3	2720	1.6	1057	3/V05L3	—	BN80A4	BE80A4	M1LA4	ME2SA4	25100	28700	48500	57500	21400	300
1.4	2450	1.1	1023	3/V03L3	—	BN80A4	BE80A4	M1LA4	ME2SA4	25000	28600	48300	57200	21100	276
1.4	2530	1.5	981	3/V04L3	—	BN80A4	BE80A4	M1LA4	ME2SA4	24900	28400	48000	56900	20800	288
1.5	2440	1.1	923	3/V03L3	—	BN80A4	BE80A4	M1LA4	ME2SA4	24700	28200	47600	56400	20400	276
1.5	2790	2.8	930	3/V06L3	—	BN80A4	BE80A4	M1LA4	ME2SA4	29400	33500	67000	77300	29800	312
1.6	2700	1.0	887	3/V04L3	—	BN80A4	BE80A4	M1LA4	ME2SA4	24500	28000	47300	56000	20100	288
1.6	2560	1.7	894	3/V05L3	—	BN80A4	BE80A4	M1LA4	ME2SA4	24500	28100	47300	56100	20200	300
1.8	2100	1.0	793	3/V03L3	—	BN80A4	BE80A4	M1LA4	ME2SA4	24100	27600	46500	55100	19400	276
1.8	2200	1.5	769	3/V04L3	—	BN80A4	BE80A4	M1LA4	ME2SA4	24000	27500	46300	54900	19200	288

A

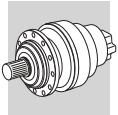

$P_1 = 0.55 \text{ kW}$

n ₂ min ⁻¹	M ₂ Nm	S	i	Motor Configurations				Rn ₂ [N]					Icon		
				IE1	IE2	IE1	IE2	MC/PC	MZ/PZ	HC	HZ	FZ			
1.8	2180	1.9	793	3/V05L3	—	BN80A4	BE80A4	M1LA4	ME2SA4	24100	27600	46500	55100	19400	300
1.9	1950	1.4	736	3/V03L3	—	BN80A4	BE80A4	M1LA4	ME2SA4	23900	27300	46000	54600	18900	276
1.9	2120	1.9	715	3/V05L3	—	BN80A4	BE80A4	M1LA4	ME2SA4	23800	27200	45900	54300	18800	300
2.0	1750	1.0	689	3/V01L3	—	BN80A4	BE80A4	—	—	7320	7320	24200	26500	6170	266
2.0	2160	1.2	710	3/V04L3	—	BN80A4	BE80A4	M1LA4	ME2SA4	23700	27100	45800	54300	18700	288
2.1	2320	2.6	671	—	3/A06L2	BN80A4	BE80A4	M1LA4	ME2SA4	28000	32000	64000	73800	26800	313
2.2	1650	1.3	623	3/V03L3	—	BN80A4	BE80A4	M1LA4	ME2SA4	23300	26600	45000	53300	17900	276
2.2	1720	2.1	623	3/V04L3	—	BN80A4	BE80A4	M1LA4	ME2SA4	23300	26600	45000	53300	17900	288
2.2	1720	2.6	623	3/V05L3	—	BN80A4	BE80A4	M1LA4	ME2SA4	23300	26600	45000	53300	17900	300
2.3	2100	1.6	594	—	3/A05L2	BN80A4	BE80A4	M1LA4	ME2SA4	23200	26500	44700	52900	17600	301
2.3	2120	2.8	611	—	3/A06L2	BN80A4	BE80A4	M1LA4	ME2SA4	27700	31600	63100	72800	25900	313
2.4	1620	1.9	568	3/V04L3	—	BN80A4	BE80A4	M1LA4	ME2SA4	23000	26300	44400	52600	17400	288
2.4	1750	2.8	576	3/V05L3	—	BN80A4	BE80A4	M1LA4	ME2SA4	23100	26300	44500	52700	17400	300
2.5	1430	1.0	562	3/V01L3	—	BN80A4	BE80A4	—	—	7110	7110	23500	25700	5770	266
2.6	1440	1.9	544	3/V03L3	—	BN80A4	BE80A4	M1LA4	ME2SA4	22900	26100	44100	52300	17100	276
2.6	1570	2.5	529	3/V05L3	—	BN80A4	BE80A4	M1LA4	ME2SA4	22800	26000	43900	52000	17000	300
2.7	1840	1.4	520	—	3/A04L2	BN80A4	BE80A4	M1LA4	ME2SA4	22700	26000	43800	51900	16900	289
2.7	1290	1.0	509	3/V01L3	—	BN80A4	BE80A4	—	—	7010	7010	23200	25300	5580	266
2.8	1750	1.0	495	—	3/A03L2	BN80A4	BE80A4	M1LA4	ME2SA4	22600	25800	43500	51600	16600	277
2.8	1740	2.2	491	—	3/A05L2	BN80A4	BE80A4	M1LA4	ME2SA4	22500	25800	43500	51500	16500	301
2.8	1450	1.4	502	3/V03L3	—	BN80A4	BE80A4	M1LA4	ME2SA4	22600	25800	43600	51700	16700	276
2.8	1290	2.3	501	3/V04L3	—	BN80A4	BE80A4	M1LA4	ME2SA4	22600	25800	43600	51700	16700	288
3.0	1660	1.5	469	—	3/A04L2	BN80A4	BE80A4	M1LA4	ME2SA4	22400	25600	43200	51200	16300	289
3.0	1220	1.9	460	3/V03L3	—	BN80A4	BE80A4	M1LA4	ME2SA4	22300	25500	43100	51000	16200	276
3.1	1240	1.1	443	3/V01L3	—	BN80A4	BE80A4	—	—	6870	6870	22700	24800	5330	266
3.1	1300	2.9	453	3/V04L3	—	BN80A4	BE80A4	M1LA4	ME2SA4	22300	25500	43000	50900	16100	288
3.2	1250	1.5	430	3/V01L3	—	BN80A4	BE80A4	—	—	6840	6840	22600	24700	5270	266
3.3	1490	2.9	422	—	3/A05L2	BN80A4	BE80A4	M1LA4	ME2SA4	22100	25200	42500	50400	15700	301
3.3	1050	0.9	415	3/V00L3	—	BN80A4	BE80A4	—	—	6810	6810	22500	26200	5210	256
3.4	1450	1.3	409	—	3/A03L2	BN80A4	BE80A4	M1LA4	ME2SA4	22000	25100	42300	50200	15600	277
3.5	1410	2.3	398	—	3/A05L2	BN80A4	BE80A4	M1LA4	ME2SA4	21900	25000	42200	50000	15400	301
3.5	1140	1.9	395	3/V03L3	—	BN80A4	BE80A4	M1LA4	ME2SA4	21800	25000	42100	49900	15400	276
3.6	1370	1.8	386	—	3/A04L2	BN80A4	BE80A4	M1LA4	ME2SA4	21800	24900	42000	49800	15300	289
3.8	1290	1.0	364	—	3/A01L2	BN80A4	BE80A4	M1LA4	ME2SA4	6680	6680	22100	24200	4990	267
3.9	1250	1.6	352	—	3/A03L2	BN80A4	BE80A4	M1LA4	ME2SA4	21500	24600	41400	49100	14800	277
4.0	1230	2.0	349	—	3/A04L2	BN80A4	BE80A4	M1LA4	ME2SA4	21500	24500	41400	49000	14800	289
4.3	1150	1.4	326	—	3/A03L2	BN80A4	BE80A4	M1LA4	ME2SA4	21200	24300	41000	48600	14400	277
4.4	1120	2.1	317	—	3/A04L2	BN80A4	BE80A4	M1LA4	ME2SA4	21200	24200	40800	48400	14300	289
4.5	1100	1.0	311	—	3/A01L2	BN80A4	BE80A4	M1LA4	ME2SA4	6530	6530	21600	23600	4740	267
4.9	1000	2.8	283	—	3/A04L2	BN80A4	BE80A4	M1LA4	ME2SA4	21000	24000	40500	48000	13800	289
5.2	950	1.1	269	—	3/A01L2	BN80A4	BE80A4	M1LA4	ME2SA4	6500	6500	21500	23500	4510	267
5.2	950	1.9	269	—	3/A03L2	BN80A4	BE80A4	M1LA4	ME2SA4	21000	24000	40500	48000	13500	277
5.2	950	1.9	269	—	3/A03L2	BN80A4	BE80A4	M1LA4	ME2SA4	21000	24000	40500	48000	13500	277
5.5	900	1.3	255	—	3/A01L2	BN80A4	BE80A4	M1LA4	ME2SA4	6500	6500	21500	23500	4430	267
6.3	780	1.1	220	—	3/A01L2	BN80A4	BE80A4	M1LA4	ME2SA4	6500	6500	21500	23500	4220	267
6.3	780	2.1	220	—	3/A03L2	BN80A4	BE80A4	M1LA4	ME2SA4	21000	24000	40500	48000	12700	277
6.8	720	0.9	203	—	3/A00L2	BN80A4	BE80A4	M1LA4	ME2SA4	6500	6500	21500	25000	4100	257
6.8	720	1.8	204	—	3/A01L2	BN80A4	BE80A4	M1LA4	ME2SA4	6500	6500	21500	23500	4120	267
7.6	650	1.6	184	—	3/A01L2	BN80A4	BE80A4	M1LA4	ME2SA4	6500	6500	21500	23500	3980	267
7.6	640	2.8	182	—	3/A03L2	BN80A4	BE80A4	M1LA4	ME2SA4	21000	24000	40500	48000	11900	277
8.1	610	0.9	171	—	3/A00L2	BN80A4	BE80A4	M1LA4	ME2SA4	6500	6500	21500	25000	3880	257
8.4	590	2.0	166	—	3/A01L2	BN80A4	BE80A4	M1LA4	ME2SA4	6500	6500	21500	23500	3840	267
10.4	475	1.2	134	—	3/A00L2	BN80A4	BE80A4	M1LA4	ME2SA4	6260	6260	20800	24200	3580	257
10.5	470	2.8	133	—	3/A01L2	BN80A4	BE80A4	M1LA4	ME2SA4	6250	6250	20800	22700	3570	267
13.0	380	1.7	107	—	3/A00L2	BN80A4	BE80A4	M1LA4	ME2SA4	5810	5810	19400	22600	3320	257
13.9	355	1.6	100	—	3/A00L2	BN80A4	BE80A4	M1LA4	ME2SA4	5680	5680	19000	22100	3240	257
15.7	315	1.8	88.6	—	3/A00L2	BN80A4	BE80A4	M1LA4	ME2SA4	5450	5450	18400	21300	3120	257
17.3	285	2.3	80.2	—	3/A00L2	BN80A4	BE80A4	M1LA4	ME2SA4	5280	5280	17800	20700	3010	257
19.6	250	2.6	71.0	—	3/A00L2	BN80A4	BE80A4	M1LA4	ME2SA4	5060	5060	17200	20000	2890	257

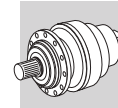

$P_1 = 0.55 \text{ kW}$

n_2 min ⁻¹	M_2 Nm	S	i					R _{n2} [N]					
								MC/PC	MZ/PZ	HC	HZ	FZ	
0.28	12600	2.2	4959	3/V10ML4	—	BXN80MA4	MXN20MA4	—	—	116400	147600	65000	348
0.28	12600	2.2	4959	3/V10ML4	—	BXN80MA4	MXN20MA4	—	—	116400	147600	65000	348
0.30	11700	2.6	4637	3/V10ML4	—	BXN80MA4	MXN20MA4	—	—	115300	146200	65000	348
0.30	11700	2.6	4637	3/V10ML4	—	BXN80MA4	MXN20MA4	—	—	115300	146200	65000	348
0.34	11800	2.6	4036	3/V10ML4	—	BXN80MA4	MXN20MA4	—	—	113100	143400	65000	348
0.34	11800	2.6	4036	3/V10ML4	—	BXN80MA4	MXN20MA4	—	—	113100	143400	65000	348
0.42	9540	2.9	3273	3/V10ML4	—	BXN80MA4	MXN20MA4	—	—	109700	139100	65000	348
0.42	9540	2.9	3273	3/V10ML4	—	BXN80MA4	MXN20MA4	—	—	109700	139100	65000	348
0.54	6750	1.0	2588	3/V06L3	—	BXN80MA4	MXN20MA4	34000	38800	77500	89500	35000	312
0.56	6190	1.8	2472	3/V07L3	—	BXN80MA4	—	40500	50700	91200	120000	45000	324
0.65	5580	1.5	2139	3/V06L3	—	BXN80MA4	MXN20MA4	33100	37700	75500	87100	35000	312
0.65	5690	1.9	2150	3/V07L3	—	BXN80MA4	—	39700	49700	89400	117600	45000	324
0.71	4920	2.5	1964	3/V07L3	—	BXN80MA4	—	39200	49000	88300	116100	45000	324
0.78	4600	1.0	1786	3/V05L3	—	BXN80MA4	MXN20MA4	27100	31000	52300	61900	24000	300
0.79	4610	1.9	1768	3/V06L3	—	BXN80MA4	MXN20MA4	32200	36700	73400	84800	35000	312
0.83	4610	1.0	1674	3/V05L3	—	BXN80MA4	MXN20MA4	26800	30700	51800	61400	24000	300
0.90	3950	0.9	1536	3/V04L3	—	BXN80MA4	MXN20MA4	26500	30300	51100	60600	24000	288
0.90	4200	2.6	1545	3/V07L3	—	BXN80MA4	—	37900	47400	85300	112200	45000	324
0.97	3680	1.3	1431	3/V05L3	—	BXN80MA4	MXN20MA4	26300	30000	50600	60000	23600	300
1.0	3790	2.2	1395	3/V06L3	—	BXN80MA4	MXN20MA4	31100	35500	71000	82000	34200	312
1.1	3170	1.1	1231	3/V04L3	—	BXN80MA4	MXN20MA4	25700	29400	49500	58700	22500	288
1.1	3170	1.7	1231	3/V05L3	—	BXN80MA4	MXN20MA4	25700	29400	49500	58700	22500	300
1.1	3160	2.5	1212	3/V06L3	—	BXN80MA4	MXN20MA4	30500	34800	69600	80300	32600	312
1.2	3170	1.1	1152	3/V04L3	—	BXN80MA4	MXN20MA4	25500	29100	49100	58200	22000	288
1.2	3190	1.4	1116	3/V05L3	—	BXN80MA4	MXN20MA4	25300	29000	48900	57900	21700	300
1.2	3130	2.6	1153	3/V06L3	—	BXN80MA4	MXN20MA4	30300	34500	69100	79800	32100	312
1.3	2720	1.6	1057	3/V05L3	—	BXN80MA4	MXN20MA4	25100	28700	48500	57500	21400	300
1.4	2450	1.1	1023	3/V03L3	—	BXN80MA4	MXN20MA4	25000	28600	48300	57200	21100	276
1.4	2530	1.5	981	3/V04L3	—	BXN80MA4	MXN20MA4	24900	28400	48000	56900	20800	288
1.5	2440	1.1	923	3/V03L3	—	BXN80MA4	MXN20MA4	24700	28200	47600	56400	20400	276
1.5	2790	2.8	930	3/V06L3	—	BXN80MA4	MXN20MA4	29400	33500	67000	77300	29800	312
1.6	2700	1.0	887	3/V04L3	—	BXN80MA4	MXN20MA4	24500	28000	47300	56000	20100	288
1.6	2560	1.7	894	3/V05L3	—	BXN80MA4	MXN20MA4	24500	28100	47300	56100	20200	300
1.8	2100	1.0	793	3/V03L3	—	BXN80MA4	MXN20MA4	24100	27600	46500	55100	19400	276
1.8	2200	1.5	769	3/V04L3	—	BXN80MA4	MXN20MA4	24000	27500	46300	54900	19200	288
1.8	2180	1.9	793	3/V05L3	—	BXN80MA4	MXN20MA4	24100	27600	46500	55100	19400	300
1.9	1950	1.4	736	3/V03L3	—	BXN80MA4	MXN20MA4	23900	27300	46000	54600	18900	276
1.9	2120	1.9	715	3/V05L3	—	BXN80MA4	MXN20MA4	23800	27200	45900	54300	18800	300
2.0	1750	1.0	689	3/V01L3	—	BXN80MA4	—	7320	7320	24200	26500	6170	266
2.0	2160	1.2	710	3/V04L3	—	BXN80MA4	MXN20MA4	23700	27100	45800	54300	18700	288
2.1	2320	2.6	671	—	3/A06L2	BXN80MA4	—	28000	32000	64000	73800	26800	312
2.2	1650	1.3	623	3/V03L3	—	BXN80MA4	MXN20MA4	23300	26600	45000	53300	17900	276
2.2	1720	2.1	623	3/V04L3	—	BXN80MA4	MXN20MA4	23300	26600	45000	53300	17900	288
2.2	1720	2.6	623	3/V05L3	—	BXN80MA4	MXN20MA4	23300	26600	45000	53300	17900	300
2.3	2100	1.6	594	—	3/A05L2	BXN80MA4	—	23200	26500	44700	52900	17600	301
2.3	2120	2.8	611	—	3/A06L2	BXN80MA4	—	27700	31600	63100	72800	25900	312
2.4	1620	1.9	568	3/V04L3	—	BXN80MA4	MXN20MA4	23000	26300	44400	52600	17400	288
2.4	1750	2.8	576	3/V05L3	—	BXN80MA4	MXN20MA4	23100	26300	44500	52700	17400	300
2.5	1430	1.0	562	3/V01L3	—	BXN80MA4	—	7110	7110	23500	25700	5770	266
2.6	1440	1.9	544	3/V03L3	—	BXN80MA4	MXN20MA4	22900	26100	44100	52300	17100	276
2.6	1570	2.5	529	3/V05L3	—	BXN80MA4	MXN20MA4	22800	26000	43900	52000	17000	300
2.7	1840	1.4	520	—	3/A04L2	BXN80MA4	—	22700	26000	43800	51900	16900	289
2.7	1290	1.0	509	3/V01L3	—	BXN80MA4	—	7010	7010	23200	25300	5580	266
2.8	1750	1.0	495	—	3/A03L2	BXN80MA4	MXN20MA4	22600	25800	43500	51600	16600	277
2.8	1740	2.2	491	—	3/A05L2	BXN80MA4	—	22500	25800	43500	51500	16500	301
2.8	1450	1.4	502	3/V03L3	—	BXN80MA4	MXN20MA4	22600	25800	43600	51700	16700	276
2.8	1290	2.3	501	3/V04L3	—	BXN80MA4	MXN20MA4	22600	25800	43600	51700	16700	288
3.0	1660	1.5	469	—	3/A04L2	BXN80MA4	—	22400	25600	43200	51200	16300	289
3.0	1220	1.9	460	3/V03L3	—	BXN80MA4	MXN20MA4	22300	25500	43100	51000	16200	276
3.1	1240	1.1	443	3/V01L3	—	BXN80MA4	—	6870	6870	22700	24800	5330	266
3.1	1300	2.9	453	3/V04L3	—	BXN80MA4	MXN20MA4	22300	25500	43000	50900	16100	288
3.2	1250	1.5	430	3/V01L3	—	BXN80MA4	—	6840	6840	22600	24700	5270	266
3.3	1490	2.9	422	—	3/A05L2	BXN80MA4	—	22100	25200	42500	50400	15700	301
3.3	1050	0.9	415	3/V00L3	—	BXN80MA4	—	6810	6810	22500	26200	5210	256
3.4	1450	1.3	409	—	3/A03L2	BXN80MA4	MXN20MA4	22000	25100	42300	50200	15600	277

A

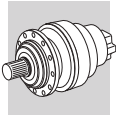

$P_1 = 0.55 \text{ kW}$

n_2 min ⁻¹	M_2 Nm	S	i					Rn_2 [N]					
				IE3	IE3	MC/PC	MZ/PZ	HC	HZ	FZ			
3.5	1410	2.3	398	—	3/A05L2	BXN80MA4	—	21900	25000	42200	50000	15400	301
3.5	1140	1.9	395	3/V03L3	—	BXN80MA4	MXN20MA4	21800	25000	42100	49900	15400	276
3.6	1370	1.8	386	—	3/A04L2	BXN80MA4	—	21800	24900	42000	49800	15300	289
3.8	1290	1.0	364	—	3/A01L2	BXN80MA4	MXN20MA4	6680	6680	22100	24200	4990	267
3.9	1250	1.6	352	—	3/A03L2	BXN80MA4	MXN20MA4	21500	24600	41400	49100	14800	277
4.0	1230	2.0	349	—	3/A04L2	BXN80MA4	—	21500	24500	41400	49000	14800	289
4.3	1150	1.4	326	—	3/A03L2	BXN80MA4	MXN20MA4	21200	24300	41000	48600	14400	277
4.4	1120	2.1	317	—	3/A04L2	BXN80MA4	—	21200	24200	40800	48400	14300	289
4.5	1100	1.0	311	—	3/A01L2	BXN80MA4	MXN20MA4	6530	6530	21600	23600	4740	267
4.9	1000	2.8	283	—	3/A04L2	BXN80MA4	—	21000	24000	40500	48000	13800	289
5.2	950	1.1	269	—	3/A01L2	BXN80MA4	MXN20MA4	6500	6500	21500	23500	4510	267
5.2	950	1.9	269	—	3/A03L2	BXN80MA4	MXN20MA4	21000	24000	40500	48000	13500	277
5.2	950	1.9	269	—	3/A03L2	BXN80MA4	MXN20MA4	21000	24000	40500	48000	13500	277
5.5	900	1.3	255	—	3/A01L2	BXN80MA4	MXN20MA4	6500	6500	21500	23500	4430	267
6.3	780	1.1	220	—	3/A01L2	BXN80MA4	MXN20MA4	6500	6500	21500	23500	4220	267
6.3	780	2.1	220	—	3/A03L2	BXN80MA4	MXN20MA4	21000	24000	40500	48000	12700	277
6.8	720	0.9	203	—	3/A00L2	BXN80MA4	MXN20MA4	6500	6500	21500	25000	4100	257
6.8	720	1.8	204	—	3/A01L2	BXN80MA4	MXN20MA4	6500	6500	21500	23500	4120	267
7.6	650	1.6	184	—	3/A01L2	BXN80MA4	MXN20MA4	6500	6500	21500	23500	3980	267
7.6	640	2.8	182	—	3/A03L2	BXN80MA4	MXN20MA4	21000	24000	40500	48000	11900	277
8.1	610	0.9	171	—	3/A00L2	BXN80MA4	MXN20MA4	6500	6500	21500	25000	3880	257
8.4	590	2.0	166	—	3/A01L2	BXN80MA4	MXN20MA4	6500	6500	21500	23500	3840	267
10.4	475	1.2	134	—	3/A00L2	BXN80MA4	MXN20MA4	6260	6260	20800	24200	3580	257
10.5	470	2.8	133	—	3/A01L2	BXN80MA4	MXN20MA4	6250	6250	20800	22700	3570	267
13.0	380	1.7	107	—	3/A00L2	BXN80MA4	MXN20MA4	5810	5810	19400	22600	3320	257
13.9	355	1.6	100	—	3/A00L2	BXN80MA4	MXN20MA4	5680	5680	19000	22100	3240	257
15.7	315	1.8	88.6	—	3/A00L2	BXN80MA4	MXN20MA4	5450	5450	18400	21300	3120	257
17.3	285	2.3	80.2	—	3/A00L2	BXN80MA4	MXN20MA4	5280	5280	17800	20700	3010	257
19.6	250	2.6	71.0	—	3/A00L2	BXN80MA4	MXN20MA4	5060	5060	17200	20000	2890	257

$P_1 = 0.75 \text{ kW}$

n_2 min ⁻¹	M_2 Nm	S	i					Rn_2 [N]							
				IE2	IE3	IE2	IE3	MC/PC	MZ/PZ	HC	HZ	FZ			
0.27	18500	2.6	5326	3/V11ML4	—	BE80B4	BX80B4	ME2SB4	MX2SB4	—	—	147800	150800	65000	360
0.28	17000	3.0	5046	3/V13ML4	—	BE80B4	BX80B4	ME2SB4	MX2SB4	—	—	192000	231000	80000	372
0.29	16500	1.7	4959	3/V10ML4	—	BE80B4	BX80B4	ME2SB4	MX2SB4	—	—	116400	147600	65000	348
0.29	16500	1.7	4959	3/V10ML4	—	BE80B4	BX80B4	ME2SB4	MX2SB4	—	—	116400	147600	65000	348
0.31	15400	1.9	4637	3/V10ML4	—	BE80B4	BX80B4	ME2SB4	MX2SB4	—	—	115300	146200	65000	348
0.31	15400	1.9	4637	3/V10ML4	—	BE80B4	BX80B4	ME2SB4	MX2SB4	—	—	115300	146200	65000	348
0.35	15500	1.9	4036	3/V10ML4	—	BE80B4	BX80B4	ME2SB4	MX2SB4	—	—	113100	143400	65000	348
0.35	15500	1.9	4036	3/V10ML4	—	BE80B4	BX80B4	ME2SB4	MX2SB4	—	—	113100	143400	65000	348
0.40	12400	2.4	3570	3/V10ML4	—	BE80B4	BX80B4	ME2SB4	MX2SB4	—	—	111100	140900	65000	348
0.40	12400	2.4	3570	3/V10ML4	—	BE80B4	BX80B4	ME2SB4	MX2SB4	—	—	111100	140900	65000	348
0.44	12500	2.2	3273	3/V10ML4	—	BE80B4	BX80B4	ME2SB4	MX2SB4	—	—	109700	139100	65000	348
0.44	12500	2.2	3273	3/V10ML4	—	BE80B4	BX80B4	ME2SB4	MX2SB4	—	—	109700	139100	65000	348
0.48	11400	2.6	2987	3/V10ML4	—	BE80B4	BX80B4	ME2SB4	MX2SB4	—	—	108300	137300	65000	348
0.48	11400	2.6	2987	3/V10ML4	—	BE80B4	BX80B4	ME2SB4	MX2SB4	—	—	108300	137300	65000	348
0.58	8140	1.4	2472	3/V07L3	—	BE80B4	BX80B4	ME2SB4	MX2SB4	40500	50700	91200	120000	45000	324
0.58	9520	2.9	2455	3/V10ML4	—	BE80B4	BX80B4	ME2SB4	MX2SB4	—	—	105300	133500	65000	348
0.58	9520	2.9	2455	3/V10ML4	—	BE80B4	BX80B4	ME2SB4	MX2SB4	—	—	105300	133500	65000	348
0.67	7350	1.2	2139	3/V06L3	—	BE80B4	BX80B4	ME2SB4	MX2SB4	33100	37700	75500	87100	35000	312
0.67	7480	1.5	2150	3/V07L3	—	BE80B4	BX80B4	ME2SB4	MX2SB4	39700	49700	89400	117600	45000	324
0.73	6470	1.9	1964	3/V07L3	—	BE80B4	BX80B4	ME2SB4	MX2SB4	39200	49000	88300	116100	45000	324
0.81	6070	1.4	1768	3/V06L3	—	BE80B4	BX80B4	ME2SB4	MX2SB4	32200	36700	73400	84800	35000	312
0.93	5520	2.0	1545	3/V07L3	—	BE80B4	BX80B4	ME2SB4	MX2SB4	37900	47400	85300	112200	45000	324
1.0	4850	1.0	1431	3/V05L3	—	BE80B4	BX80B4	ME2SB4	MX2SB4	26300	30000	50600	60000	23600	300
1.0	4990	1.7	1395	3/V06L3	—	BE80B4	BX80B4	ME2SB4	MX2SB4	31100	35500	71000	82000	34200	312
1.0	4910	2.5	1411	3/V07L3	—	BE80B4	BX80B4	ME2SB4	MX2SB4	37400	46800	84200	110800	44100	324
1.2	4170	1.3	1231	3/V05L3	—	BE80B4	BX80B4	ME2SB4	MX2SB4	25700	29400	49500	58700	22500	300
1.2	4120	2.0	1153	3/V06L3	—	BE80B4	BX80B4	ME2SB4	MX2SB4	30300	34500	69100	79800	32100	312
1.2	4160	1.9	1212	3/V06L3	—	BE80B4	BX80B4	ME2SB4	MX2SB4	30500	34800	69600	80300	32600	312
1.2	4200	2.5	1159	3/V07L3	—	BE80B4	BX80B4	ME2SB4	MX2SB4	36400	45500	81900	107700	41300	324

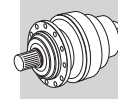



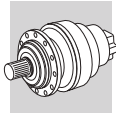

$P_1 = 0.75 \text{ kW}$

n ₂ min ⁻¹	M ₂ Nm	S	i	Gearbox Options				Rn ₂ [N]					Icon		
				IE2	IE3	IE2	IE3	MC/PC	MZ/PZ	HC	HZ	FZ			
1.3	4200	1.1	1116	3/V05L3	—	BE80B4	BX80B4	ME2SB4	MX2SB4	25300	29000	48900	57900	21700	300
1.4	3580	1.2	1057	3/V05L3	—	BE80B4	BX80B4	ME2SB4	MX2SB4	25100	28700	48500	57500	21400	300
1.4	3550	2.7	992	3/V06L3	—	BE80B4	BX80B4	ME2SB4	MX2SB4	29700	33800	67600	78100	30500	312
1.5	3320	1.2	981	3/V04L3	—	BE80B4	BX80B4	ME2SB4	MX2SB4	24900	28400	48000	56900	20800	288
1.5	3680	2.1	930	3/V06L3	—	BE80B4	BX80B4	ME2SB4	MX2SB4	29400	33500	67000	77300	29800	312
1.6	3360	1.3	894	3/V05L3	—	BE80B4	BX80B4	ME2SB4	MX2SB4	24500	28100	47300	56100	20200	300
1.8	2870	1.5	793	3/V05L3	—	BE80B4	BX80B4	ME2SB4	MX2SB4	24100	27600	46500	55100	19400	300
1.8	2830	2.7	791	3/V06L3	—	BE80B4	BX80B4	ME2SB4	MX2SB4	28700	32700	65500	75600	28300	312
1.9	2560	1.1	736	3/V03L3	—	BE80B4	BX80B4	ME2SB4	MX2SB4	23900	27300	46000	54600	18900	276
1.9	2890	1.2	769	3/V04L3	—	BE80B4	BX80B4	ME2SB4	MX2SB4	24000	27500	46300	54900	19200	288
2.0	2840	0.9	710	3/V04L3	—	BE80B4	BX80B4	ME2SB4	MX2SB4	23700	27100	45800	54300	18700	288
2.0	2790	1.5	715	3/V05L3	—	BE80B4	BX80B4	ME2SB4	MX2SB4	23800	27200	45900	54300	18800	300
2.0	2790	2.7	698	3/V06L3	—	BE80B4	BX80B4	ME2SB4	MX2SB4	28200	32200	64300	74200	27100	312
2.1	3060	2.0	671	—	3/A06L2	BE80B4	BX80B4	ME2SB4	MX2SB4	28000	32000	64000	73800	26800	313
2.3	2790	2.1	611	—	3/A06L2	BE80B4	BX80B4	ME2SB4	MX2SB4	27700	31600	63100	72800	25900	313
2.3	2170	1.0	623	3/V03L3	—	BE80B4	BX80B4	ME2SB4	MX2SB4	23300	26600	45000	53300	17900	276
2.3	2260	1.6	623	3/V04L3	—	BE80B4	BX80B4	ME2SB4	MX2SB4	23300	26600	45000	53300	17900	288
2.3	2260	2.0	623	3/V05L3	—	BE80B4	BX80B4	ME2SB4	MX2SB4	23300	26600	45000	53300	17900	300
2.4	2770	1.2	594	—	3/A05L2	BE80B4	BX80B4	ME2SB4	MX2SB4	23200	26500	44700	52900	17600	301
2.5	2140	1.5	568	3/V04L3	—	BE80B4	BX80B4	ME2SB4	MX2SB4	23000	26300	44400	52600	17400	288
2.5	2300	2.1	576	3/V05L3	—	BE80B4	BX80B4	ME2SB4	MX2SB4	23100	26300	44500	52700	17400	300
2.6	2530	2.9	555	—	3/A06L2	BE80B4	BX80B4	ME2SB4	MX2SB4	27300	31100	62200	71800	25100	313
2.6	1890	1.4	544	3/V03L3	—	BE80B4	BX80B4	ME2SB4	MX2SB4	22900	26100	44100	52300	17100	276
2.7	2070	1.9	529	3/V05L3	—	BE80B4	BX80B4	ME2SB4	MX2SB4	22800	26000	43900	52000	17000	300
2.8	2420	1.0	520	—	3/A04L2	BE80B4	BX80B4	ME2SB4	MX2SB4	22700	26000	43800	51900	16900	289
2.8	1910	1.1	502	3/V03L3	—	BE80B4	BX80B4	ME2SB4	MX2SB4	22600	25800	43600	51700	16700	276
2.9	2290	1.7	491	—	3/A05L2	BE80B4	BX80B4	ME2SB4	MX2SB4	22500	25800	43500	51500	16500	301
2.9	1700	1.8	501	3/V04L3	—	BE80B4	BX80B4	ME2SB4	MX2SB4	22600	25800	43600	51700	16700	288
3.0	2180	1.1	469	—	3/A04L2	BE80B4	BX80B4	ME2SB4	MX2SB4	22400	25600	43200	51200	16300	289
3.1	1600	1.4	460	3/V03L3	—	BE80B4	BX80B4	ME2SB4	MX2SB4	22300	25500	43100	51000	16200	276
3.1	1850	2.6	462	3/V05L3	—	BE80B4	BX80B4	ME2SB4	MX2SB4	22300	25500	43100	51000	16200	300
3.2	1700	2.2	453	3/V04L3	—	BE80B4	BX80B4	ME2SB4	MX2SB4	22300	25500	43000	50900	16100	288
3.3	1640	1.1	430	3/V01L3	—	BE80B4	BX80B4	—	—	6840	6840	22600	24700	5270	266
3.4	1960	2.2	422	—	3/A05L2	BE80B4	BX80B4	ME2SB4	MX2SB4	22100	25200	42500	50400	15700	301
3.5	1900	1.0	409	—	3/A03L2	BE80B4	BX80B4	ME2SB4	MX2SB4	22000	25100	42300	50200	15600	277
3.6	1850	1.7	398	—	3/A05L2	BE80B4	BX80B4	ME2SB4	MX2SB4	21900	25000	42200	50000	15400	301
3.6	1510	1.5	395	3/V03L3	—	BE80B4	BX80B4	ME2SB4	MX2SB4	21800	25000	42100	49900	15400	276
3.6	1580	2.4	396	3/V05L3	—	BE80B4	BX80B4	ME2SB4	MX2SB4	21900	25000	42100	50000	15400	300
3.7	1800	1.4	386	—	3/A04L2	BE80B4	BX80B4	ME2SB4	MX2SB4	21800	24900	42000	49800	15300	289
3.7	1450	2.4	384	3/V04L3	—	BE80B4	BX80B4	ME2SB4	MX2SB4	21800	24900	41900	49700	15200	288
4.1	1640	1.2	352	—	3/A03L2	BE80B4	BX80B4	ME2SB4	MX2SB4	21500	24600	41400	49100	14800	277
4.1	1620	1.5	349	—	3/A04L2	BE80B4	BX80B4	ME2SB4	MX2SB4	21500	24500	41400	49000	14800	289
4.3	1530	2.4	329	—	3/A05L2	BE80B4	BX80B4	ME2SB4	MX2SB4	21300	24300	41000	48600	14500	301
4.4	1520	1.1	326	—	3/A03L2	BE80B4	BX80B4	ME2SB4	MX2SB4	21200	24300	41000	48600	14400	277
4.5	1480	1.6	317	—	3/A04L2	BE80B4	BX80B4	ME2SB4	MX2SB4	21200	24200	40800	48400	14300	289
5.1	1320	2.2	283	—	3/A04L2	BE80B4	BX80B4	ME2SB4	MX2SB4	21000	24000	40500	48000	13800	289
5.1	1300	2.8	280	—	3/A05L2	BE80B4	BX80B4	ME2SB4	MX2SB4	21000	24000	40500	48000	13700	301
5.3	1250	1.5	269	—	3/A03L2	BE80B4	BX80B4	ME2SB4	MX2SB4	21000	24000	40500	48000	13500	277
5.3	1250	1.5	269	—	3/A03L2	BE80B4	BX80B4	ME2SB4	MX2SB4	21000	24000	40500	48000	13500	277
5.6	1190	1.0	255	—	3/A01L2	BE80B4	BX80B4	ME2SB4	MX2SB4	6500	6500	21500	23500	4430	267
6.5	1020	1.6	220	—	3/A03L2	BE80B4	BX80B4	ME2SB4	MX2SB4	21000	24000	40500	48000	12700	277
7.0	950	1.4	204	—	3/A01L2	BE80B4	BX80B4	ME2SB4	MX2SB4	6500	6500	21500	23500	4120	267
7.8	860	1.2	184	—	3/A01L2	BE80B4	BX80B4	ME2SB4	MX2SB4	6500	6500	21500	23500	3980	267
7.9	850	2.2	182	—	3/A03L2	BE80B4	BX80B4	ME2SB4	MX2SB4	21000	24000	40500	48000	11900	277
8.6	770	1.5	166	—	3/A01L2	BE80B4	BX80B4	ME2SB4	MX2SB4	6500	6500	21500	23500	3840	267
10.8	620	2.1	133	—	3/A01L2	BE80B4	BX80B4	ME2SB4	MX2SB4	6250	6250	20800	22700	3570	267
13.4	500	1.3	107	—	3/A00L2	BE80B4	BX80B4	ME2SB4	MX2SB4	5810	5810	19400	22600	3320	257
14.0	475	2.4	102	—	3/A01L2	BE80B4	BX80B4	ME2SB4	MX2SB4	5710	5710	19100	20900	3260	267
14.3	465	1.2	100	—	3/A00L2	BE80B4	BX80B4	ME2SB4	MX2SB4	5680	5680	19000	22100	3240	257
16.1	415	1.3	88.6	—	3/A00L2	BE80B4	BX80B4	ME2SB4	MX2SB4	5450	5450	18400	21300	3120	257
17.8	375	1.7	80.2	—	3/A00L2	BE80B4	BX80B4	ME2SB4	MX2SB4	5280	5280	17800	20700	3010	257
20.1	330	2.0	71.0	—	3/A00L2	BE80B4	BX80B4	ME2SB4	MX2SB4	5060	5060	17200	20000	2890	257
23.4	285	2.3	61.2	—	3/A00L2	BE80B4	BX80B4	ME2SB4	MX2SB4	4820	4820	16400	19100	2750	257
27.6	240	2.3	51.8	—	3/A00L2	BE80B4	BX80B4	ME2SB4	MX2SB4	4560	4560	15600	18200	2610	257
36	185	3.0	39.6	—	3/A00L2	BE80B4	BX80B4	ME2SB4	MX2SB4	4170	4170	14400	16800	2380	257

A



$P_1 = 0.75 \text{ kW}$

n_2 min ⁻¹	M_2 Nm	S	i					R _{n2} [N]					
								MC/PC	MZ/PZ	HC	HZ	FZ	
0.27	18500	2.6	5326	3/V11ML4	—	BXN80MB4	MXN20MA4	—	—	147800	150800	65000	360
0.28	17000	3.0	5046	3/V13ML4	—	BXN80MB4	MXN20MA4	—	—	192000	231000	80000	372
0.29	16500	1.7	4959	3/V10ML4	—	BXN80MB4	MXN20MA4	—	—	116400	147600	65000	348
0.29	16500	1.7	4959	3/V10ML4	—	BXN80MB4	MXN20MA4	—	—	116400	147600	65000	348
0.31	15400	1.9	4637	3/V10ML4	—	BXN80MB4	MXN20MA4	—	—	115300	146200	65000	348
0.31	15400	1.9	4637	3/V10ML4	—	BXN80MB4	MXN20MA4	—	—	115300	146200	65000	348
0.35	15500	1.9	4036	3/V10ML4	—	BXN80MB4	MXN20MA4	—	—	113100	143400	65000	348
0.35	15500	1.9	4036	3/V10ML4	—	BXN80MB4	MXN20MA4	—	—	113100	143400	65000	348
0.40	12400	2.4	3570	3/V10ML4	—	BXN80MB4	MXN20MA4	—	—	111100	140900	65000	348
0.40	12400	2.4	3570	3/V10ML4	—	BXN80MB4	MXN20MA4	—	—	111100	140900	65000	348
0.44	12500	2.2	3273	3/V10ML4	—	BXN80MB4	MXN20MA4	—	—	109700	139100	65000	348
0.44	12500	2.2	3273	3/V10ML4	—	BXN80MB4	MXN20MA4	—	—	109700	139100	65000	348
0.48	11400	2.6	2987	3/V10ML4	—	BXN80MB4	MXN20MA4	—	—	108300	137300	65000	348
0.48	11400	2.6	2987	3/V10ML4	—	BXN80MB4	MXN20MA4	—	—	108300	137300	65000	348
0.58	8140	1.4	2472	3/V07L3	—	BXN80MB4	MXN20MB4	40500	50700	91200	120000	45000	324
0.58	9520	2.9	2455	3/V10ML4	—	BXN80MB4	MXN20MA4	—	—	105300	133500	65000	348
0.58	9520	2.9	2455	3/V10ML4	—	BXN80MB4	MXN20MA4	—	—	105300	133500	65000	348
0.67	7350	1.2	2139	3/V06L3	—	BXN80MB4	MXN20MB4	33100	37700	75500	87100	35000	312
0.67	7480	1.5	2150	3/V07L3	—	BXN80MB4	MXN20MB4	39700	49700	89400	117600	45000	324
0.73	6470	1.9	1964	3/V07L3	—	BXN80MB4	MXN20MB4	39200	49000	88300	116100	45000	324
0.81	6070	1.4	1768	3/V06L3	—	BXN80MB4	MXN20MB4	32200	36700	73400	84800	35000	312
0.93	5520	2.0	1545	3/V07L3	—	BXN80MB4	MXN20MB4	37900	47400	85300	112200	45000	324
1.0	4850	1.0	1431	3/V05L3	—	BXN80MB4	MXN20MB4	26300	30000	50600	60000	23600	300
1.0	4990	1.7	1395	3/V06L3	—	BXN80MB4	MXN20MB4	31100	35500	71000	82000	34200	312
1.0	4910	2.5	1411	3/V07L3	—	BXN80MB4	MXN20MB4	37400	46800	84200	110800	44100	324
1.2	4170	1.3	1231	3/V05L3	—	BXN80MB4	MXN20MB4	25700	29400	49500	58700	22500	300
1.2	4120	2.0	1153	3/V06L3	—	BXN80MB4	MXN20MB4	30300	34500	69100	79800	32100	312
1.2	4160	1.9	1212	3/V06L3	—	BXN80MB4	MXN20MB4	30500	34800	69600	80300	32600	312
1.2	4200	2.5	1159	3/V07L3	—	BXN80MB4	MXN20MB4	36400	45500	81900	107700	41300	324
1.3	4200	1.1	1116	3/V05L3	—	BXN80MB4	MXN20MB4	25300	29000	48900	57900	21700	300
1.4	3580	1.2	1057	3/V05L3	—	BXN80MB4	MXN20MB4	25100	28700	48500	57500	21400	300
1.4	3550	2.7	992	3/V06L3	—	BXN80MB4	MXN20MB4	29700	33800	67600	78100	30500	312
1.5	3320	1.2	981	3/V04L3	—	BXN80MB4	MXN20MB4	24900	28400	48000	56900	20800	288
1.5	3680	2.1	930	3/V06L3	—	BXN80MB4	MXN20MB4	29400	33500	67000	77300	29800	312
1.6	3360	1.3	894	3/V05L3	—	BXN80MB4	MXN20MB4	24500	28100	47300	56100	20200	300
1.8	2870	1.5	793	3/V05L3	—	BXN80MB4	MXN20MB4	24100	27600	46500	55100	19400	300
1.8	2830	2.7	791	3/V06L3	—	BXN80MB4	MXN20MB4	28700	32700	65500	75600	28300	312
1.9	2560	1.1	736	3/V03L3	—	BXN80MB4	MXN20MB4	23900	27300	46000	54600	18900	276
1.9	2890	1.2	769	3/V04L3	—	BXN80MB4	MXN20MB4	24000	27500	46300	54900	19200	288
2.0	2840	0.9	710	3/V04L3	—	BXN80MB4	MXN20MB4	23700	27100	45800	54300	18700	288
2.0	2790	1.5	715	3/V05L3	—	BXN80MB4	MXN20MB4	23800	27200	45900	54300	18800	300
2.0	2790	2.7	698	3/V06L3	—	BXN80MB4	MXN20MB4	28200	32200	64300	74200	27100	312
2.1	3060	2.0	671	—	3/A06L2	BXN80MB4	—	28000	32000	64000	73800	26800	313
2.3	2790	2.1	611	—	3/A06L2	BXN80MB4	—	27700	31600	63100	72800	25900	313
2.3	2170	1.0	623	3/V03L3	—	BXN80MB4	MXN20MB4	23300	26600	45000	53300	17900	276
2.3	2260	1.6	623	3/V04L3	—	BXN80MB4	MXN20MB4	23300	26600	45000	53300	17900	288
2.3	2260	2.0	623	3/V05L3	—	BXN80MB4	MXN20MB4	23300	26600	45000	53300	17900	300
2.4	2770	1.2	594	—	3/A05L2	BXN80MB4	—	23200	26500	44700	52900	17600	301
2.5	2140	1.5	568	3/V04L3	—	BXN80MB4	MXN20MB4	23000	26300	44400	52600	17400	288
2.5	2300	2.1	576	3/V05L3	—	BXN80MB4	MXN20MB4	23100	26300	44500	52700	17400	300
2.6	2530	2.9	555	—	3/A06L2	BXN80MB4	—	27300	31100	62200	71800	25100	313
2.6	1890	1.4	544	3/V03L3	—	BXN80MB4	MXN20MB4	22900	26100	44100	52300	17100	276
2.7	2070	1.9	529	3/V05L3	—	BXN80MB4	MXN20MB4	22800	26000	43900	52000	17000	300
2.8	2420	1.0	520	—	3/A04L2	BXN80MB4	—	22700	26000	43800	51900	16900	289
2.8	1910	1.1	502	3/V03L3	—	BXN80MB4	MXN20MB4	22600	25800	43600	51700	16700	276
2.9	2290	1.7	491	—	3/A05L2	BXN80MB4	—	22500	25800	43500	51500	16500	301
2.9	1700	1.8	501	3/V04L3	—	BXN80MB4	MXN20MB4	22600	25800	43600	51700	16700	288
3.0	2180	1.1	469	—	3/A04L2	BXN80MB4	—	22400	25600	43200	51200	16300	289
3.1	1600	1.4	460	3/V03L3	—	BXN80MB4	MXN20MB4	22300	25500	43100	51000	16200	276
3.1	1850	2.6	462	3/V05L3	—	BXN80MB4	MXN20MB4	22300	25500	43100	51000	16200	300
3.2	1700	2.2	453	3/V04L3	—	BXN80MB4	MXN20MB4	22300	25500	43000	50900	16100	288
3.3	1640	1.1	430	3/V01L3	—	BXN80MB4	—	6840	6840	22600	24700	5270	266
3.4	1960	2.2	422	—	3/A05L2	BXN80MB4	—	22100	25200	42500	50400	15700	301
3.5	1900	1.0	409	—	3/A03L2	BXN80MB4	MXN20MB4	22000	25100	42300	50200	15600	277
3.6	1850	1.7	398	—	3/A05L2	BXN80MB4	—	21900	25000	42200	50000	15400	301
3.6	1510	1.5	395	3/V03L3	—	BXN80MB4	MXN20MB4	21800	25000	42100	49900	15400	276
3.6	1580	2.4	396	3/V05L3	—	BXN80MB4	MXN20MB4	21900	25000	42100	50000	15400	300

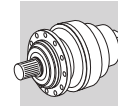

$P_1 = 0.75 \text{ kW}$

n_2 min ⁻¹	M_2 Nm	S	i	3V		IE3		R_{n2} [N]					Icon
				3V04L3	3/A04L2	IE3	IE3	MC/PC	MZ/PZ	HC	HZ	FZ	
3.7	1800	1.4	386	—	3/A04L2	BXN80MB4	—	21800	24900	42000	49800	15300	289
3.7	1450	2.4	384	3V04L3	—	BXN80MB4	MXN20MB4	21800	24900	41900	49700	15200	288
4.1	1640	1.2	352	—	3/A03L2	BXN80MB4	MXN20MB4	21500	24600	41400	49100	14800	277
4.1	1620	1.5	349	—	3/A04L2	BXN80MB4	—	21500	24500	41400	49000	14800	289
4.3	1530	2.4	329	—	3/A05L2	BXN80MB4	—	21300	24300	41000	48600	14500	301
4.4	1520	1.1	326	—	3/A03L2	BXN80MB4	MXN20MB4	21200	24300	41000	48600	14400	277
4.5	1480	1.6	317	—	3/A04L2	BXN80MB4	—	21200	24200	40800	48400	14300	289
5.1	1320	2.2	283	—	3/A04L2	BXN80MB4	—	21000	24000	40500	48000	13800	289
5.1	1300	2.8	280	—	3/A05L2	BXN80MB4	—	21000	24000	40500	48000	13700	301
5.3	1250	1.5	269	—	3/A03L2	BXN80MB4	MXN20MB4	21000	24000	40500	48000	13500	277
5.3	1250	1.5	269	—	3/A03L2	BXN80MB4	MXN20MB4	21000	24000	40500	48000	13500	277
5.6	1190	1.0	255	—	3/A01L2	BXN80MB4	MXN20MB4	6500	6500	21500	23500	4430	267
6.5	1020	1.6	220	—	3/A03L2	BXN80MB4	MXN20MB4	21000	24000	40500	48000	12700	277
7.0	950	1.4	204	—	3/A01L2	BXN80MB4	MXN20MB4	6500	6500	21500	23500	4120	267
7.8	860	1.2	184	—	3/A01L2	BXN80MB4	MXN20MB4	6500	6500	21500	23500	3980	267
7.9	850	2.2	182	—	3/A03L2	BXN80MB4	MXN20MB4	21000	24000	40500	48000	11900	277
8.6	770	1.5	166	—	3/A01L2	BXN80MB4	MXN20MB4	6500	6500	21500	23500	3840	267
10.8	620	2.1	133	—	3/A01L2	BXN80MB4	MXN20MB4	6250	6250	20800	22700	3570	267
13.4	500	1.3	107	—	3/A00L2	BXN80MB4	MXN20MB4	5810	5810	19400	22600	3320	257
14.0	475	2.4	102	—	3/A01L2	BXN80MB4	MXN20MB4	5710	5710	19100	20900	3260	267
14.3	465	1.2	100	—	3/A00L2	BXN80MB4	MXN20MB4	5680	5680	19000	22100	3240	257
16.1	415	1.3	88.6	—	3/A00L2	BXN80MB4	MXN20MB4	5450	5450	18400	21300	3120	257
17.8	375	1.7	80.2	—	3/A00L2	BXN80MB4	MXN20MB4	5280	5280	17800	20700	3010	257
20.1	330	2.0	71.0	—	3/A00L2	BXN80MB4	MXN20MB4	5060	5060	17200	20000	2890	257
23.4	285	2.3	61.2	—	3/A00L2	BXN80MB4	MXN20MB4	4820	4820	16400	19100	2750	257
27.6	240	2.3	51.8	—	3/A00L2	BXN80MB4	MXN20MB4	4560	4560	15600	18200	2610	257
36	185	3.0	39.6	—	3/A00L2	BXN80MB4	MXN20MB4	4170	4170	14400	16800	2380	257

$P_1 = 1.1 \text{ kW}$

n_2 min ⁻¹	M_2 Nm	S	i	3V		IE2		IE3		R_{n2} [N]					Icon
				3V11ML4	3V13ML4	IE2	IE3	IE2	IE3	MC/PC	MZ/PZ	HC	HZ	FZ	
0.27	27300	1.7	5326	3V11ML4	—	BE90S4	BX90S4	ME3SA4	MX3SA4	—	—	147800	150800	65000	360
0.28	25200	2.0	5046	3V13ML4	—	BE90S4	BX90S4	ME3SA4	MX3SA4	—	—	192000	231000	80000	372
0.29	24400	1.1	4959	3/V10ML4	—	BE90S4	BX90S4	ME3SA4	MX3SA4	—	—	116400	147600	65000	348
0.29	24400	1.1	4959	3/V10ML4	—	BE90S4	BX90S4	ME3SA4	MX3SA4	—	—	116400	147600	65000	348
0.31	22900	1.3	4637	3/V10ML4	—	BE90S4	BX90S4	ME3SA4	MX3SA4	—	—	115300	146200	65000	348
0.31	22900	1.3	4637	3/V10ML4	—	BE90S4	BX90S4	ME3SA4	MX3SA4	—	—	115300	146200	65000	348
0.32	22900	2.1	4410	3/V11ML4	—	BE90S4	BX90S4	ME3SA4	MX3SA4	—	—	143900	146800	65000	360
0.32	23600	2.4	4536	3/V13ML4	—	BE90S4	BX90S4	ME3SA4	MX3SA4	—	—	192000	231000	80000	372
0.35	22900	1.3	4036	3/V10ML4	—	BE90S4	BX90S4	ME3SA4	MX3SA4	—	—	113100	143400	65000	348
0.35	22900	1.3	4036	3/V10ML4	—	BE90S4	BX90S4	ME3SA4	MX3SA4	—	—	113100	143400	65000	348
0.35	20500	2.4	4106	3/V11ML4	—	BE90S4	BX90S4	ME3SA4	MX3SA4	—	—	142400	145300	65000	360
0.35	21000	2.9	4046	3/V13ML4	—	BE90S4	BX90S4	ME3SA4	MX3SA4	—	—	192000	231000	80000	372
0.40	18300	1.6	3570	3/V10ML4	—	BE90S4	BX90S4	ME3SA4	MX3SA4	—	—	111100	140900	65000	348
0.40	18300	1.6	3570	3/V10ML4	—	BE90S4	BX90S4	ME3SA4	MX3SA4	—	—	111100	140900	65000	348
0.40	17800	2.4	3557	3/V11ML4	—	BE90S4	BX90S4	ME3SA4	MX3SA4	—	—	139500	142400	65000	360
0.41	19900	2.9	3515	3/V13ML4	—	BE90S4	BX90S4	ME3SA4	MX3SA4	—	—	192000	231000	80000	372
0.44	18600	1.5	3273	3/V10ML4	—	BE90S4	BX90S4	ME3SA4	MX3SA4	—	—	109700	139100	65000	348
0.44	18600	1.5	3273	3/V10ML4	—	BE90S4	BX90S4	ME3SA4	MX3SA4	—	—	109700	139100	65000	348
0.44	18300	2.6	3222	3/V11ML4	—	BE90S4	BX90S4	ME3SA4	MX3SA4	—	—	137600	140400	65000	360
0.44	18500	2.9	3263	3/V13ML4	—	BE90S4	BX90S4	ME3SA4	MX3SA4	—	—	192000	231000	80000	372
0.47	17200	2.8	3063	3/V11ML4	—	BE90S4	BX90S4	ME3SA4	MX3SA4	—	—	136600	139400	65000	360
0.48	16900	1.8	2987	3/V10ML4	—	BE90S4	BX90S4	ME3SA4	MX3SA4	—	—	108300	137300	65000	348
0.48	16900	1.8	2987	3/V10ML4	—	BE90S4	BX90S4	ME3SA4	MX3SA4	—	—	108300	137300	65000	348
0.58	12000	0.9	2472	3V07L3	—	BE90S4	BX90S4	ME3SA4	MX3SA4	40500	50700	91200	120000	45000	324
0.58	14100	1.9	2455	3/V10ML4	—	BE90S4	BX90S4	ME3SA4	MX3SA4	—	—	105300	133500	65000	348
0.58	14100	1.9	2455	3/V10ML4	—	BE90S4	BX90S4	ME3SA4	MX3SA4	—	—	105300	133500	65000	348
0.66	12200	2.3	2156	3/V10ML4	—	BE90S4	BX90S4	ME3SA4	MX3SA4	—	—	103400	131100	65000	348
0.66	12200	2.3	2156	3/V10ML4	—	BE90S4	BX90S4	ME3SA4	MX3SA4	—	—	103400	131100	65000	348
0.67	11100	1.0	2150	3V07L3	—	BE90S4	BX90S4	ME3SA4	MX3SA4	39700	49700	89400	117600	45000	324
0.71	11400	2.6	2016	3/V10ML4	—	BE90S4	BX90S4	ME3SA4	MX3SA4	—	—	102400	129800	65000	348
0.71	11400	2.6	2016	3/V10ML4	—	BE90S4	BX90S4	ME3SA4	MX3SA4	—	—	102400	129800	65000	348

A

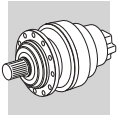

$P_1 = 1.1 \text{ kW}$

n ₂ min ⁻¹	M ₂ Nm	S	i					Rn ₂ [N]							
				IE2	IE3	IE2	IE3	MC/PC	MZ/PZ	HC	HZ	FZ			
0.73	9570	1.3	1964	3/V07L3	—	BE90S4	BX90S4	ME3SA4	MX3SA4	39200	49000	88300	116100	45000	324
0.77	10500	2.6	1855	3/V10ML4	—	BE90S4	BX90S4	ME3SA4	MX3SA4	—	—	101200	128300	65000	348
0.77	10500	2.6	1855	3/V10ML4	—	BE90S4	BX90S4	ME3SA4	MX3SA4	—	—	101200	128300	65000	348
0.81	8990	1.0	1768	3/V06L3	—	BE90S4	BX90S4	ME3SA4	MX3SA4	32200	36700	73400	84800	35000	312
0.93	8180	1.3	1545	3/V07L3	—	BE90S4	BX90S4	ME3SA4	MX3SA4	37900	47400	85300	112200	45000	324
1.0	7380	1.1	1395	3/V06L3	—	BE90S4	BX90S4	ME3SA4	MX3SA4	31100	35500	71000	82000	34200	312
1.0	7270	1.7	1411	3/V07L3	—	BE90S4	BX90S4	ME3SA4	MX3SA4	37400	46800	84200	110800	44100	324
1.1	6640	2.2	1288	3/V07L3	—	BE90S4	BX90S4	ME3SA4	MX3SA4	36900	46200	83100	109300	42800	324
1.2	6100	1.4	1153	3/V06L3	—	BE90S4	BX90S4	ME3SA4	MX3SA4	30300	34500	69100	79800	32100	312
1.2	6160	1.3	1212	3/V06L3	—	BE90S4	BX90S4	ME3SA4	MX3SA4	30500	34800	69600	80300	32600	312
1.2	6210	1.7	1159	3/V07L3	—	BE90S4	BX90S4	ME3SA4	MX3SA4	36400	45500	81900	107700	41300	324
1.4	5250	1.8	992	3/V06L3	—	BE90S4	BX90S4	ME3SA4	MX3SA4	29700	33800	67600	78100	30500	312
1.4	5370	2.7	1015	3/V07L3	—	BE90S4	BX90S4	ME3SA4	MX3SA4	35700	44600	80300	105700	39500	324
1.5	5440	1.5	930	3/V06L3	—	BE90S4	BX90S4	ME3SA4	MX3SA4	29400	33500	67000	77300	29800	312
1.6	4930	2.5	920	3/V07L3	—	BE90S4	BX90S4	ME3SA4	MX3SA4	35200	44000	79200	104200	38200	324
1.8	4250	1.0	793	3/V05L3	—	BE90S4	BX90S4	ME3SA4	MX3SA4	24100	27600	46500	55100	19400	300
1.8	4190	1.8	791	3/V06L3	—	BE90S4	BX90S4	ME3SA4	MX3SA4	28700	32700	65500	75600	28300	312
1.8	4520	2.2	773	3/V07L3	—	BE90S4	BX90S4	ME3SA4	MX3SA4	34300	42900	77300	101600	36100	324
2.0	4130	1.0	715	3/V05L3	—	BE90S4	BX90S4	ME3SA4	MX3SA4	23800	27200	45900	54300	18800	300
2.0	4130	1.8	698	3/V06L3	—	BE90S4	BX90S4	ME3SA4	MX3SA4	28200	32200	64300	74200	27100	312
2.1	4530	1.3	671	—	3/A06L2	BE90S4	BX90S4	ME3SA4	MX3SA4	28000	32000	64000	73800	26800	313
2.2	3870	2.4	661	3/V06L3	—	BE90S4	BX90S4	ME3SA4	MX3SA4	28000	31900	63800	73700	26600	312
2.3	4120	1.4	611	—	3/A06L2	BE90S4	BX90S4	ME3SA4	MX3SA4	27700	31600	63100	72800	25900	313
2.3	3340	1.1	623	3/V04L3	—	BE90S4	BX90S4	ME3SA4	MX3SA4	23300	26600	45000	53300	17900	288
2.3	3340	1.3	623	3/V05L3	—	BE90S4	BX90S4	ME3SA4	MX3SA4	23300	26600	45000	53300	17900	300
2.5	3160	1.0	568	3/V04L3	—	BE90S4	BX90S4	ME3SA4	MX3SA4	23000	26300	44400	52600	17400	288
2.5	3410	1.4	576	3/V05L3	—	BE90S4	BX90S4	ME3SA4	MX3SA4	23100	26300	44500	52700	17400	300
2.5	3330	2.6	569	3/V06L3	—	BE90S4	BX90S4	ME3SA4	MX3SA4	27400	31200	62500	72100	25300	312
2.6	3740	1.9	555	—	3/A06L2	BE90S4	BX90S4	ME3SA4	MX3SA4	27300	31100	62200	71800	25100	313
2.6	2800	1.0	544	3/V03L3	—	BE90S4	BX90S4	ME3SA4	MX3SA4	22900	26100	44100	52300	17100	276
2.7	3060	1.3	529	3/V05L3	—	BE90S4	BX90S4	ME3SA4	MX3SA4	22800	26000	43900	52000	17000	300
2.7	3080	2.5	527	3/V06L3	—	BE90S4	BX90S4	ME3SA4	MX3SA4	27100	30900	61800	71300	24700	312
2.8	3410	2.1	505	—	3/A06L2	BE90S4	BX90S4	ME3SA4	MX3SA4	26900	30700	61400	70900	24400	313
2.9	3380	1.1	491	—	3/A05L2	BE90S4	BX90S4	ME3SA4	MX3SA4	22500	25800	43500	51500	16500	301
2.9	2510	1.2	501	3/V04L3	—	BE90S4	BX90S4	ME3SA4	MX3SA4	22600	25800	43600	51700	16700	288
3.1	2370	1.0	460	3/V03L3	—	BE90S4	BX90S4	ME3SA4	MX3SA4	22300	25500	43100	51000	16200	276
3.1	2730	1.8	462	3/V05L3	—	BE90S4	BX90S4	ME3SA4	MX3SA4	22300	25500	43100	51000	16200	300
3.2	2520	1.5	453	3/V04L3	—	BE90S4	BX90S4	ME3SA4	MX3SA4	22300	25500	43000	50900	16100	288
3.3	2940	2.6	435	—	3/A06L2	BE90S4	BX90S4	ME3SA4	MX3SA4	26400	30100	60100	69400	23200	313
3.4	2910	1.5	422	—	3/A05L2	BE90S4	BX90S4	ME3SA4	MX3SA4	22100	25200	42500	50400	15700	301
3.6	2740	1.2	398	—	3/A05L2	BE90S4	BX90S4	ME3SA4	MX3SA4	21900	25000	42200	50000	15400	301
3.6	2230	1.0	395	3/V03L3	—	BE90S4	BX90S4	ME3SA4	MX3SA4	21800	25000	42100	49900	15400	276
3.6	2340	1.6	396	3/V05L3	—	BE90S4	BX90S4	ME3SA4	MX3SA4	21900	25000	42100	50000	15400	300
3.7	2660	0.9	386	—	3/A04L2	BE90S4	BX90S4	ME3SA4	MX3SA4	21800	24900	42000	49800	15300	289
3.7	2620	2.2	388	—	3/A06L2	BE90S4	BX90S4	ME3SA4	MX3SA4	25900	29600	59100	68300	22300	313
3.7	2140	1.6	384	3/V04L3	—	BE90S4	BX90S4	ME3SA4	MX3SA4	21800	24900	41900	49700	15200	288
3.8	2560	2.4	380	—	3/A06L2	BE90S4	BX90S4	ME3SA4	MX3SA4	25900	29500	59000	68100	22200	313
4.1	2400	1.0	349	—	3/A04L2	BE90S4	BX90S4	ME3SA4	MX3SA4	21500	24500	41400	49000	14800	289
4.3	2270	1.6	329	—	3/A05L2	BE90S4	BX90S4	ME3SA4	MX3SA4	21300	24300	41000	48600	14500	301
4.5	2180	1.1	317	—	3/A04L2	BE90S4	BX90S4	ME3SA4	MX3SA4	21200	24200	40800	48400	14300	289
5.1	1950	1.5	283	—	3/A04L2	BE90S4	BX90S4	ME3SA4	MX3SA4	21000	24000	40500	48000	13800	289
5.1	1930	1.9	280	—	3/A05L2	BE90S4	BX90S4	ME3SA4	MX3SA4	21000	24000	40500	48000	13700	301
5.3	1850	1.0	269	—	3/A03L2	BE90S4	BX90S4	ME3SA4	MX3SA4	21000	24000	40500	48000	13500	277
5.3	1850	1.0	269	—	3/A03L2	BE90S4	BX90S4	ME3SA4	MX3SA4	21000	24000	40500	48000	13500	277
5.7	1720	2.0	250	—	3/A04L2	BE90S4	BX90S4	ME3SA4	MX3SA4	21000	24000	40500	48000	13200	289
5.9	1660	2.6	241	—	3/A05L2	BE90S4	BX90S4	ME3SA4	MX3SA4	21000	24000	40500	48000	13000	301
6.3	1560	2.2	226	—	3/A04L2	BE90S4	BX90S4	ME3SA4	MX3SA4	21000	24000	40500	48000	12800	289
6.5	1520	1.1	220	—	3/A03L2	BE90S4	BX90S4	ME3SA4	MX3SA4	21000	24000	40500	48000	12700	277
6.7	1460	2.1	212	—	3/A05L2	BE90S4	BX90S4	ME3SA4	MX3SA4	21000	24000	40500	48000	12500	301
6.7	1460	2.1	212	—	3/A05L2	BE90S4	BX90S4	ME3SA4	MX3SA4	21000	24000	40500	48000	12500	301
7.0	1410	0.9	204	—	3/A01L2	BE90S4	BX90S4	ME3SA4	MX3SA4	6500	6500	21500	23500	4120	267
7.0	1410	2.5	205	—	3/A04L2	BE90S4	BX90S4	ME3SA4	MX3SA4	21000	24000	40500	48000	12400	289
7.9	1250	1.5	182	—	3/A03L2	BE90S4	BX90S4	ME3SA4	MX3SA4	21000	24000	40500	48000	11900	277
8.2	1200	2.5	174	—	3/A04L2	BE90S4	BX90S4	ME3SA4	MX3SA4	21000	24000	40500	48000	11700	289
8.2	1210	3.0	175	—	3/A05L2	BE90S4	BX90S4	ME3SA4	MX3SA4	21000	24000	40500	48000	11700	301

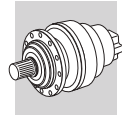

$P_1 = 1.1 \text{ kW}$

n_2 min ⁻¹	M_2 Nm	S	i					R_{n_2} [N]							
						IE2	IE3	IE2	IE3	MC/PC	MZ/PZ	HC		HZ	FZ
8.6	1140	1.0	166	—	3/A01L2	BE90S4	BX90S4	ME3SA4	MX3SA4	6500	6500	21500	23500	3840	267
8.8	1120	2.6	162	—	3/A04L2	BE90S4	BX90S4	ME3SA4	MX3SA4	21000	24000	40500	48000	11400	289
8.8	1120	2.6	162	—	3/A05L2	BE90S4	BX90S4	ME3SA4	MX3SA4	21000	24000	40500	48000	11400	301
9.6	1030	2.3	149	—	3/A04L2	BE90S4	BX90S4	ME3SA4	MX3SA4	21000	24000	40400	47900	11100	289
10.8	920	1.4	133	—	3/A01L2	BE90S4	BX90S4	ME3SA4	MX3SA4	6250	6250	20800	22700	3570	267
12.2	810	3.0	117	—	3/A04L2	BE90S4	BX90S4	ME3SA4	MX3SA4	19300	22100	37600	44500	10300	289
14.0	700	1.6	102	—	3/A01L2	BE90S4	BX90S4	ME3SA4	MX3SA4	5710	5710	19100	20900	3260	267
14.8	670	2.5	96.9	—	3/A03L2	BE90S4	BX90S4	ME3SA4	MX3SA4	18200	20700	35500	42100	9630	277
16.1	610	0.9	88.6	—	3/A00L2	BE90S4	BX90S4	ME3SA4	MX3SA4	5450	5450	18400	21300	3120	257
16.2	610	2.7	88.5	—	3/A03L2	BE90S4	BX90S4	ME3SA4	MX3SA4	17600	20100	34600	41000	9340	277
17.6	560	2.3	81.3	—	3/A01L2	BE90S4	BX90S4	ME3SA4	MX3SA4	5300	5300	17900	19600	3030	267
17.8	550	1.2	80.2	—	3/A00L2	BE90S4	BX90S4	ME3SA4	MX3SA4	5280	5280	17800	20700	3010	257
19.3	510	2.2	74.2	—	3/A01L2	BE90S4	BX90S4	ME3SA4	MX3SA4	5140	5140	17400	19000	2940	267
20.1	490	1.3	71.0	—	3/A00L2	BE90S4	BX90S4	ME3SA4	MX3SA4	5060	5060	17200	20000	2890	257
23.4	420	1.5	61.2	—	3/A00L2	BE90S4	BX90S4	ME3SA4	MX3SA4	4820	4820	16400	19100	2750	257
27.6	355	1.5	51.8	—	3/A00L2	BE90S4	BX90S4	ME3SA4	MX3SA4	4560	4560	15600	18200	2610	257
29.1	340	2.5	49.1	—	3/A01L2	BE90S4	BX90S4	ME3SA4	MX3SA4	4480	4480	15400	16800	2560	267
34	285	2.3	41.5	—	3/A00L2	BE90S4	BX90S4	ME3SA4	MX3SA4	4240	4240	14600	17000	2420	257
36	275	2.0	39.6	—	3/A00L2	BE90S4	BX90S4	ME3SA4	MX3SA4	4170	4170	14400	16800	2380	257
45	220	3.0	31.7	—	3/A00L2	BE90S4	BX90S4	ME3SA4	MX3SA4	3870	3870	13500	15700	2210	257

$P_1 = 1.1 \text{ kW}$

n_2 min ⁻¹	M_2 Nm	S	i					R_{n_2} [N]					
						IE3	IE3	MC/PC	MZ/PZ	HC	HZ	FZ	
0.27	27300	1.7	5326	3/V11ML4	—	BXN90S4	—	—	—	147800	150800	65000	360
0.28	25200	2.0	5046	3/V13ML4	—	BXN90S4	—	—	—	192000	231000	80000	372
0.29	24400	1.1	4959	3/V10ML4	—	BXN90S4	—	—	—	116400	147600	65000	348
0.29	24400	1.1	4959	3/V10ML4	—	BXN90S4	—	—	—	116400	147600	65000	348
0.31	22900	1.3	4637	3/V10ML4	—	BXN90S4	—	—	—	115300	146200	65000	348
0.31	22900	1.3	4637	3/V10ML4	—	BXN90S4	—	—	—	115300	146200	65000	348
0.32	22900	2.1	4410	3/V11ML4	—	BXN90S4	—	—	—	143900	146800	65000	360
0.32	23600	2.4	4536	3/V13ML4	—	BXN90S4	—	—	—	192000	231000	80000	372
0.35	22900	1.3	4036	3/V10ML4	—	BXN90S4	—	—	—	113100	143400	65000	348
0.35	22900	1.3	4036	3/V10ML4	—	BXN90S4	—	—	—	113100	143400	65000	348
0.35	20500	2.4	4106	3/V11ML4	—	BXN90S4	—	—	—	142400	145300	65000	360
0.35	21000	2.9	4046	3/V13ML4	—	BXN90S4	—	—	—	192000	231000	80000	372
0.40	18300	1.6	3570	3/V10ML4	—	BXN90S4	—	—	—	111100	140900	65000	348
0.40	18300	1.6	3570	3/V10ML4	—	BXN90S4	—	—	—	111100	140900	65000	348
0.40	17800	2.4	3557	3/V11ML4	—	BXN90S4	—	—	—	139500	142400	65000	360
0.41	19900	2.9	3515	3/V13ML4	—	BXN90S4	—	—	—	192000	231000	80000	372
0.44	18600	1.5	3273	3/V10ML4	—	BXN90S4	—	—	—	109700	139100	65000	348
0.44	18600	1.5	3273	3/V10ML4	—	BXN90S4	—	—	—	109700	139100	65000	348
0.44	18300	2.6	3222	3/V11ML4	—	BXN90S4	—	—	—	137600	140400	65000	360
0.44	18500	2.9	3263	3/V13ML4	—	BXN90S4	—	—	—	192000	231000	80000	372
0.47	17200	2.8	3063	3/V11ML4	—	BXN90S4	—	—	—	136600	139400	65000	360
0.48	16900	1.8	2987	3/V10ML4	—	BXN90S4	—	—	—	108300	137300	65000	348
0.48	16900	1.8	2987	3/V10ML4	—	BXN90S4	—	—	—	108300	137300	65000	348
0.58	12000	0.9	2472	3/V07L3	—	BXN90S4	—	40500	50700	91200	120000	45000	324
0.58	14100	1.9	2455	3/V10ML4	—	BXN90S4	—	—	—	105300	133500	65000	348
0.58	14100	1.9	2455	3/V10ML4	—	BXN90S4	—	—	—	105300	133500	65000	348
0.66	12200	2.3	2156	3/V10ML4	—	BXN90S4	—	—	—	103400	131100	65000	348
0.66	12200	2.3	2156	3/V10ML4	—	BXN90S4	—	—	—	103400	131100	65000	348
0.67	11100	1.0	2150	3/V07L3	—	BXN90S4	—	39700	49700	89400	117600	45000	324
0.71	11400	2.6	2016	3/V10ML4	—	BXN90S4	—	—	—	102400	129800	65000	348
0.71	11400	2.6	2016	3/V10ML4	—	BXN90S4	—	—	—	102400	129800	65000	348
0.73	9570	1.3	1964	3/V07L3	—	BXN90S4	—	39200	49000	88300	116100	45000	324
0.77	10500	2.6	1855	3/V10ML4	—	BXN90S4	—	—	—	101200	128300	65000	348
0.77	10500	2.6	1855	3/V10ML4	—	BXN90S4	—	—	—	101200	128300	65000	348
0.81	8990	1.0	1768	3/V06L3	—	BXN90S4	—	32200	36700	73400	84800	35000	312
0.93	8180	1.3	1545	3/V07L3	—	BXN90S4	—	37900	47400	85300	112200	45000	324
1.0	7380	1.1	1395	3/V06L3	—	BXN90S4	—	31100	35500	71000	82000	34200	312



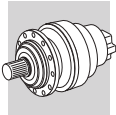

$P_1 = 1.1 \text{ kW}$

n ₂ min ⁻¹	M ₂ Nm	S	i			IE3	IE3	Rn ₂ [N]					
				MC/PC	MZ/PZ			HC	HZ	FZ			
1.0	7270	1.7	1411	3/V07L3	—	BXN90S4	—	37400	46800	84200	110800	44100	324
1.1	6640	2.2	1288	3/V07L3	—	BXN90S4	—	36900	46200	83100	109300	42800	324
1.2	6100	1.4	1153	3/V06L3	—	BXN90S4	—	30300	34500	69100	79800	32100	312
1.2	6160	1.3	1212	3/V06L3	—	BXN90S4	—	30500	34800	69600	80300	32600	312
1.2	6210	1.7	1159	3/V07L3	—	BXN90S4	—	36400	45500	81900	107700	41300	324
1.4	5250	1.8	992	3/V06L3	—	BXN90S4	—	29700	33800	67600	78100	30500	312
1.4	5370	2.7	1015	3/V07L3	—	BXN90S4	—	35700	44600	80300	105700	39500	324
1.5	5440	1.5	930	3/V06L3	—	BXN90S4	—	29400	33500	67000	77300	29800	312
1.6	4930	2.5	920	3/V07L3	—	BXN90S4	—	35200	44000	79200	104200	38200	324
1.8	4250	1.0	793	3/V05L3	—	BXN90S4	—	24100	27600	46500	55100	19400	300
1.8	4190	1.8	791	3/V06L3	—	BXN90S4	—	28700	32700	65500	75600	28300	312
1.8	4520	2.2	773	3/V07L3	—	BXN90S4	—	34300	42900	77300	101600	36100	324
2.0	4130	1.0	715	3/V05L3	—	BXN90S4	—	23800	27200	45900	54300	18800	300
2.0	4130	1.8	698	3/V06L3	—	BXN90S4	—	28200	32200	64300	74200	27100	312
2.1	4530	1.3	671	—	3/A06L2	BXN90S4	—	28000	32000	64000	73800	26800	313
2.2	3870	2.4	661	3/V06L3	—	BXN90S4	—	28000	31900	63800	73700	26600	312
2.3	4120	1.4	611	—	3/A06L2	BXN90S4	—	27700	31600	63100	72800	25900	313
2.3	3340	1.1	623	3/V04L3	—	BXN90S4	—	23300	26600	45000	53300	17900	288
2.3	3340	1.3	623	3/V05L3	—	BXN90S4	—	23300	26600	45000	53300	17900	300
2.5	3160	1.0	568	3/V04L3	—	BXN90S4	—	23000	26300	44400	52600	17400	288
2.5	3410	1.4	576	3/V05L3	—	BXN90S4	—	23100	26300	44500	52700	17400	300
2.5	3330	2.6	569	3/V06L3	—	BXN90S4	—	27400	31200	62500	72100	25300	312
2.6	3740	1.9	555	—	3/A06L2	BXN90S4	—	27300	31100	62200	71800	25100	313
2.6	2800	1.0	544	3/V03L3	—	BXN90S4	—	22900	26100	44100	52300	17100	276
2.7	3060	1.3	529	3/V05L3	—	BXN90S4	—	22800	26000	43900	52000	17000	300
2.7	3080	2.5	527	3/V06L3	—	BXN90S4	—	27100	30900	61800	71300	24700	312
2.8	3410	2.1	505	—	3/A06L2	BXN90S4	—	26900	30700	61400	70900	24400	313
2.9	3380	1.1	491	—	3/A05L2	BXN90S4	—	22500	25800	43500	51500	16500	301
2.9	2510	1.2	501	3/V04L3	—	BXN90S4	—	22600	25800	43600	51700	16700	288
3.1	2370	1.0	460	3/V03L3	—	BXN90S4	—	22300	25500	43100	51000	16200	276
3.1	2730	1.8	462	3/V05L3	—	BXN90S4	—	22300	25500	43100	51000	16200	300
3.2	2520	1.5	453	3/V04L3	—	BXN90S4	—	22300	25500	43000	50900	16100	288
3.3	2940	2.6	435	—	3/A06L2	BXN90S4	—	26400	30100	60100	69400	23200	313
3.4	2910	1.5	422	—	3/A05L2	BXN90S4	—	22100	25200	42500	50400	15700	301
3.6	2740	1.2	398	—	3/A05L2	BXN90S4	—	21900	25000	42200	50000	15400	301
3.6	2230	1.0	395	3/V03L3	—	BXN90S4	—	21800	25000	42100	49900	15400	276
3.6	2340	1.6	396	3/V05L3	—	BXN90S4	—	21900	25000	42100	50000	15400	300
3.7	2660	0.9	386	—	3/A04L2	BXN90S4	—	21800	24900	42000	49800	15300	289
3.7	2620	2.2	388	—	3/A06L2	BXN90S4	—	25900	29600	59100	68300	22300	313
3.7	2140	1.6	384	3/V04L3	—	BXN90S4	—	21800	24900	41900	49700	15200	288
3.8	2560	2.4	380	—	3/A06L2	BXN90S4	—	25900	29500	59000	68100	22200	313
4.1	2400	1.0	349	—	3/A04L2	BXN90S4	—	21500	24500	41400	49000	14800	289
4.3	2270	1.6	329	—	3/A05L2	BXN90S4	—	21300	24300	41000	48600	14500	301
4.5	2180	1.1	317	—	3/A04L2	BXN90S4	—	21200	24200	40800	48400	14300	289
5.1	1950	1.5	283	—	3/A04L2	BXN90S4	—	21000	24000	40500	48000	13800	289
5.1	1930	1.9	280	—	3/A05L2	BXN90S4	—	21000	24000	40500	48000	13700	301
5.3	1850	1.0	269	—	3/A03L2	BXN90S4	—	21000	24000	40500	48000	13500	277
5.3	1850	1.0	269	—	3/A03L2	BXN90S4	—	21000	24000	40500	48000	13500	277
5.7	1720	2.0	250	—	3/A04L2	BXN90S4	—	21000	24000	40500	48000	13200	289
5.9	1660	2.6	241	—	3/A05L2	BXN90S4	—	21000	24000	40500	48000	13000	301
6.3	1560	2.2	226	—	3/A04L2	BXN90S4	—	21000	24000	40500	48000	12800	289
6.5	1520	1.1	220	—	3/A03L2	BXN90S4	—	21000	24000	40500	48000	12700	277
6.7	1460	2.1	212	—	3/A05L2	BXN90S4	—	21000	24000	40500	48000	12500	301
6.7	1460	2.1	212	—	3/A05L2	BXN90S4	—	21000	24000	40500	48000	12500	301
7.0	1410	0.9	204	—	3/A01L2	BXN90S4	—	6500	6500	21500	23500	4120	267
7.0	1410	2.5	205	—	3/A04L2	BXN90S4	—	21000	24000	40500	48000	12400	289
7.9	1250	1.5	182	—	3/A03L2	BXN90S4	—	21000	24000	40500	48000	11900	277
8.2	1200	2.5	174	—	3/A04L2	BXN90S4	—	21000	24000	40500	48000	11700	289
8.2	1210	3.0	175	—	3/A05L2	BXN90S4	—	21000	24000	40500	48000	11700	301
8.6	1140	1.0	166	—	3/A01L2	BXN90S4	—	6500	6500	21500	23500	3840	267
8.8	1120	2.6	162	—	3/A04L2	BXN90S4	—	21000	24000	40500	48000	11400	289
8.8	1120	2.6	162	—	3/A05L2	BXN90S4	—	21000	24000	40500	48000	11400	301
9.6	1030	2.3	149	—	3/A04L2	BXN90S4	—	21000	24000	40400	47900	11100	289
10.8	920	1.4	133	—	3/A01L2	BXN90S4	—	6250	6250	20800	22700	3570	267
12.2	810	3.0	117	—	3/A04L2	BXN90S4	—	19300	22100	37600	44500	10300	289

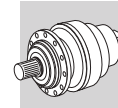

$P_1 = 1.1 \text{ kW}$

n_2 min ⁻¹	M_2 Nm	S	i					Rn_2 [N]					
				IE3	IE3	MC/PC	MZ/PZ	HC	HZ	FZ			
14.0	700	1.6	102	—	3/A01L2	BXN90S4	—	5710	5710	19100	20900	3260	267
14.8	670	2.5	96.9	—	3/A03L2	BXN90S4	—	18200	20700	35500	42100	9630	277
16.1	610	0.9	88.6	—	3/A00L2	BXN90S4	—	5450	5450	18400	21300	3120	257
16.2	610	2.7	88.5	—	3/A03L2	BXN90S4	—	17600	20100	34600	41000	9340	277
17.6	560	2.3	81.3	—	3/A01L2	BXN90S4	—	5300	5300	17900	19600	3030	267
17.8	550	1.2	80.2	—	3/A00L2	BXN90S4	—	5280	5280	17800	20700	3010	257
19.3	510	2.2	74.2	—	3/A01L2	BXN90S4	—	5140	5140	17400	19000	2940	267
20.1	490	1.3	71.0	—	3/A00L2	BXN90S4	—	5060	5060	17200	20000	2890	257
23.4	420	1.5	61.2	—	3/A00L2	BXN90S4	—	4820	4820	16400	19100	2750	257
27.6	355	1.5	51.8	—	3/A00L2	BXN90S4	—	4560	4560	15600	18200	2610	257
29.1	340	2.5	49.1	—	3/A01L2	BXN90S4	—	4480	4480	15400	16800	2560	267
34	285	2.3	41.5	—	3/A00L2	BXN90S4	—	4240	4240	14600	17000	2420	257
36	275	2.0	39.6	—	3/A00L2	BXN90S4	—	4170	4170	14400	16800	2380	257
45	220	3.0	31.7	—	3/A00L2	BXN90S4	—	3870	3870	13500	15700	2210	257

$P_1 = 1.5 \text{ kW}$

n_2 min ⁻¹	M_2 Nm	S	i					Rn_2 [N]							
				IE2	IE3	IE2	IE3	MC/PC	MZ/PZ	HC	HZ	FZ			
0.27	36900	1.3	5326	3/V11ML4	—	BE90LA4	BX90LA4	ME3SB4	MX3SB4	—	—	147800	150800	65000	360
0.28	34100	1.5	5046	3/V13ML4	—	BE90LA4	BX90LA4	ME3SB4	MX3SB4	—	—	192000	231000	80000	372
0.31	30900	1.0	4637	3/V10ML4	—	BE90LA4	BX90LA4	ME3SB4	MX3SB4	—	—	115300	146200	65000	348
0.31	30900	1.0	4637	3/V10ML4	—	BE90LA4	BX90LA4	ME3SB4	MX3SB4	—	—	115300	146200	65000	348
0.32	31000	1.5	4410	3/V11ML4	—	BE90LA4	BX90LA4	ME3SB4	MX3SB4	—	—	143900	146800	65000	360
0.32	31900	1.8	4536	3/V13ML4	—	BE90LA4	BX90LA4	ME3SB4	MX3SB4	—	—	192000	231000	80000	372
0.35	30900	1.0	4036	3/V10ML4	—	BE90LA4	BX90LA4	ME3SB4	MX3SB4	—	—	113100	143400	65000	348
0.35	30900	1.0	4036	3/V10ML4	—	BE90LA4	BX90LA4	ME3SB4	MX3SB4	—	—	113100	143400	65000	348
0.35	27700	1.8	4106	3/V11ML4	—	BE90LA4	BX90LA4	ME3SB4	MX3SB4	—	—	142400	145300	65000	360
0.35	28400	2.1	4046	3/V13ML4	—	BE90LA4	BX90LA4	ME3SB4	MX3SB4	—	—	192000	231000	80000	372
0.40	24800	1.2	3570	3/V10ML4	—	BE90LA4	BX90LA4	ME3SB4	MX3SB4	—	—	111100	140900	65000	348
0.40	24800	1.2	3570	3/V10ML4	—	BE90LA4	BX90LA4	ME3SB4	MX3SB4	—	—	111100	140900	65000	348
0.40	24000	1.8	3557	3/V11ML4	—	BE90LA4	BX90LA4	ME3SB4	MX3SB4	—	—	139500	142400	65000	360
0.41	26900	2.1	3515	3/V13ML4	—	BE90LA4	BX90LA4	ME3SB4	MX3SB4	—	—	192000	231000	80000	372
0.44	25100	1.1	3273	3/V10ML4	—	BE90LA4	BX90LA4	ME3SB4	MX3SB4	—	—	109700	139100	65000	348
0.44	25100	1.1	3273	3/V10ML4	—	BE90LA4	BX90LA4	ME3SB4	MX3SB4	—	—	109700	139100	65000	348
0.44	24700	1.9	3222	3/V11ML4	—	BE90LA4	BX90LA4	ME3SB4	MX3SB4	—	—	137600	140400	65000	360
0.44	25000	2.2	3263	3/V13ML4	—	BE90LA4	BX90LA4	ME3SB4	MX3SB4	—	—	192000	231000	80000	372
0.47	23200	2.1	3063	3/V11ML4	—	BE90LA4	BX90LA4	ME3SB4	MX3SB4	—	—	136600	139400	65000	360
0.48	22900	1.3	2987	3/V10ML4	—	BE90LA4	BX90LA4	ME3SB4	MX3SB4	—	—	108300	137300	65000	348
0.48	22900	1.3	2987	3/V10ML4	—	BE90LA4	BX90LA4	ME3SB4	MX3SB4	—	—	108300	137300	65000	348
0.54	20400	2.3	2663	3/V11ML4	—	BE90LA4	BX90LA4	ME3SB4	MX3SB4	—	—	133900	136600	65000	360
0.58	19000	1.4	2455	3/V10ML4	—	BE90LA4	BX90LA4	ME3SB4	MX3SB4	—	—	105300	133500	65000	348
0.58	19000	1.4	2455	3/V10ML4	—	BE90LA4	BX90LA4	ME3SB4	MX3SB4	—	—	105300	133500	65000	348
0.66	16500	1.7	2156	3/V10ML4	—	BE90LA4	BX90LA4	ME3SB4	MX3SB4	—	—	103400	131100	65000	348
0.66	16500	1.7	2156	3/V10ML4	—	BE90LA4	BX90LA4	ME3SB4	MX3SB4	—	—	103400	131100	65000	348
0.71	15500	1.9	2016	3/V10ML4	—	BE90LA4	BX90LA4	ME3SB4	MX3SB4	—	—	102400	129800	65000	348
0.71	15500	1.9	2016	3/V10ML4	—	BE90LA4	BX90LA4	ME3SB4	MX3SB4	—	—	102400	129800	65000	348
0.73	12900	1.0	1964	3/V07L3	—	BE90LA4	BX90LA4	ME3SB4	MX3SB4	39200	49000	88300	116100	45000	324
0.77	14200	1.9	1855	3/V10ML4	—	BE90LA4	BX90LA4	ME3SB4	MX3SB4	—	—	101200	128300	65000	348
0.77	14200	1.9	1855	3/V10ML4	—	BE90LA4	BX90LA4	ME3SB4	MX3SB4	—	—	101200	128300	65000	348
0.88	12500	2.2	1617	3/V10ML4	—	BE90LA4	BX90LA4	ME3SB4	MX3SB4	—	—	99200	125800	65000	348
0.88	12500	2.2	1617	3/V10ML4	—	BE90LA4	BX90LA4	ME3SB4	MX3SB4	—	—	99200	125800	65000	348
0.93	11000	1.0	1545	3/V07L3	—	BE90LA4	BX90LA4	ME3SB4	MX3SB4	37900	47400	85300	112200	45000	324
1.0	9820	1.3	1411	3/V07L3	—	BE90LA4	BX90LA4	ME3SB4	MX3SB4	37400	46800	84200	110800	44100	324
1.1	8970	1.6	1288	3/V07L3	—	BE90LA4	BX90LA4	ME3SB4	MX3SB4	36900	46200	83100	109300	42800	324
1.2	8240	1.0	1153	3/V06L3	—	BE90LA4	BX90LA4	ME3SB4	MX3SB4	30300	34500	69100	79800	32100	312
1.2	8320	0.9	1212	3/V06L3	—	BE90LA4	BX90LA4	ME3SB4	MX3SB4	30500	34800	69600	80300	32600	312
1.2	8400	1.3	1159	3/V07L3	—	BE90LA4	BX90LA4	ME3SB4	MX3SB4	36400	45500	81900	107700	41300	324
1.4	7090	1.3	992	3/V06L3	—	BE90LA4	BX90LA4	ME3SB4	MX3SB4	29700	33800	67600	78100	30500	312
1.4	7260	2.0	1015	3/V07L3	—	BE90LA4	BX90LA4	ME3SB4	MX3SB4	35700	44600	80300	105700	39500	324
1.5	7350	1.1	930	3/V06L3	—	BE90LA4	BX90LA4	ME3SB4	MX3SB4	29400	33500	67000	77300	29800	312
1.6	6670	1.8	920	3/V07L3	—	BE90LA4	BX90LA4	ME3SB4	MX3SB4	35200	44000	79200	104200	38200	324

A

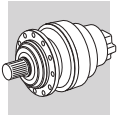

$P_1 = 1.5 \text{ kW}$

n_2 min ⁻¹	M_2 Nm	S	i	IE2		IE3		IE2		IE3		R _{n2} [N]					
				MC/PC	MZ/PZ	HC	HZ	FZ									
1.8	5660	1.4	791	3/V06L3	—	BE90LA4	BX90LA4	ME3SB4	MX3SB4	28700	32700	65500	75600	28300	312		
1.8	6110	1.6	773	3/V07L3	—	BE90LA4	BX90LA4	ME3SB4	MX3SB4	34300	42900	77300	101600	36100	324		
1.9	5510	2.6	761	3/V07L3	—	BE90LA4	BX90LA4	ME3SB4	MX3SB4	34300	42800	77100	101400	35900	324		
2.0	5580	1.4	698	3/V06L3	—	BE90LA4	BX90LA4	ME3SB4	MX3SB4	28200	32200	64300	74200	27100	312		
2.1	6120	1.0	671	—	3/A06L2	BE90LA4	BX90LA4	ME3SB4	MX3SB4	28000	32000	64000	73800	26800	313		
2.2	5220	1.8	661	3/V06L3	—	BE90LA4	BX90LA4	ME3SB4	MX3SB4	28000	31900	63800	73700	26600	312		
2.3	5570	1.1	611	—	3/A06L2	BE90LA4	BX90LA4	ME3SB4	MX3SB4	27700	31600	63100	72800	25900	313		
2.3	4510	1.0	623	3/V05L3	—	BE90LA4	BX90LA4	ME3SB4	MX3SB4	23300	26600	45000	53300	17900	300		
2.5	4610	1.1	576	3/V05L3	—	BE90LA4	BX90LA4	ME3SB4	MX3SB4	23100	26300	44500	52700	17400	300		
2.5	4500	1.9	569	3/V06L3	—	BE90LA4	BX90LA4	ME3SB4	MX3SB4	27400	31200	62500	72100	25300	312		
2.6	5060	1.4	555	—	3/A06L2	BE90LA4	BX90LA4	ME3SB4	MX3SB4	27300	31100	62200	71800	25100	313		
2.7	4130	0.9	529	3/V05L3	—	BE90LA4	BX90LA4	ME3SB4	MX3SB4	22800	26000	43900	52000	17000	300		
2.7	4170	1.8	527	3/V06L3	—	BE90LA4	BX90LA4	ME3SB4	MX3SB4	27100	30900	61800	71300	24700	312		
2.8	4600	1.6	505	—	3/A06L2	BE90LA4	BX90LA4	ME3SB4	MX3SB4	26900	30700	61400	70900	24400	313		
3.1	3690	1.3	462	3/V05L3	—	BE90LA4	BX90LA4	ME3SB4	MX3SB4	22300	25500	43100	51000	16200	300		
3.2	3410	1.1	453	3/V04L3	—	BE90LA4	BX90LA4	ME3SB4	MX3SB4	22300	25500	43000	50900	16100	288		
3.3	3970	2.0	435	—	3/A06L2	BE90LA4	BX90LA4	ME3SB4	MX3SB4	26400	30100	60100	69400	23200	313		
3.3	4000	2.3	439	—	3/A07L2	BE90LA4	BX90LA4	ME3SB4	MX3SB4	31700	39600	71300	93800	29900	325		
3.3	3410	2.6	427	3/V06L3	—	BE90LA4	BX90LA4	ME3SB4	MX3SB4	26300	30000	59900	69200	23000	312		
3.4	3930	1.1	422	—	3/A05L2	BE90LA4	BX90LA4	ME3SB4	MX3SB4	22100	25200	42500	50400	15700	301		
3.5	3690	2.5	405	—	3/A07L2	BE90LA4	BX90LA4	ME3SB4	MX3SB4	31300	39100	70500	92700	29100	325		
3.6	3170	1.2	396	3/V05L3	—	BE90LA4	BX90LA4	ME3SB4	MX3SB4	21900	25000	42100	50000	15400	300		
3.6	3160	2.4	395	3/V06L3	—	BE90LA4	BX90LA4	ME3SB4	MX3SB4	26000	29600	59300	68400	22400	312		
3.7	3540	1.6	388	—	3/A06L2	BE90LA4	BX90LA4	ME3SB4	MX3SB4	25900	29600	59100	68300	22300	313		
3.7	2890	1.2	384	3/V04L3	—	BE90LA4	BX90LA4	ME3SB4	MX3SB4	21800	24900	41900	49700	15200	288		
3.7	3160	2.9	386	3/V07L3	—	BE90LA4	BX90LA4	ME3SB4	MX3SB4	31100	38900	70000	92100	28600	324		
3.8	3460	1.8	380	—	3/A06L2	BE90LA4	BX90LA4	ME3SB4	MX3SB4	25900	29500	59000	68100	22200	313		
4.3	3060	1.2	329	—	3/A05L2	BE90LA4	BX90LA4	ME3SB4	MX3SB4	21300	24300	41000	48600	14500	301		
4.5	2930	2.3	321	—	3/A06L2	BE90LA4	BX90LA4	ME3SB4	MX3SB4	25200	28800	57500	66400	20900	313		
5.1	2640	1.1	283	—	3/A04L2	BE90LA4	BX90LA4	ME3SB4	MX3SB4	21000	24000	40500	48000	13800	289		
5.1	2610	1.4	280	—	3/A05L2	BE90LA4	BX90LA4	ME3SB4	MX3SB4	21000	24000	40500	48000	13700	301		
5.4	2430	2.3	267	—	3/A06L2	BE90LA4	BX90LA4	ME3SB4	MX3SB4	25000	28500	57000	65800	19700	313		
5.7	2330	1.5	250	—	3/A04L2	BE90LA4	BX90LA4	ME3SB4	MX3SB4	21000	24000	40500	48000	13200	289		
5.9	2240	1.9	241	—	3/A05L2	BE90LA4	BX90LA4	ME3SB4	MX3SB4	21000	24000	40500	48000	13000	301		
6.3	2100	1.7	226	—	3/A04L2	BE90LA4	BX90LA4	ME3SB4	MX3SB4	21000	24000	40500	48000	12800	289		
6.7	1970	1.6	212	—	3/A05L2	BE90LA4	BX90LA4	ME3SB4	MX3SB4	21000	24000	40500	48000	12500	301		
6.7	1970	1.6	212	—	3/A05L2	BE90LA4	BX90LA4	ME3SB4	MX3SB4	21000	24000	40500	48000	12500	301		
7.0	1910	1.8	205	—	3/A04L2	BE90LA4	BX90LA4	ME3SB4	MX3SB4	21000	24000	40500	48000	12400	289		
7.9	1690	1.1	182	—	3/A03L2	BE90LA4	BX90LA4	ME3SB4	MX3SB4	21000	24000	40500	48000	11900	277		
8.2	1620	1.8	174	—	3/A04L2	BE90LA4	BX90LA4	ME3SB4	MX3SB4	21000	24000	40500	48000	11700	289		
8.2	1630	2.2	175	—	3/A05L2	BE90LA4	BX90LA4	ME3SB4	MX3SB4	21000	24000	40500	48000	11700	301		
8.8	1510	1.9	162	—	3/A04L2	BE90LA4	BX90LA4	ME3SB4	MX3SB4	21000	24000	40500	48000	11400	289		
8.8	1510	1.9	162	—	3/A05L2	BE90LA4	BX90LA4	ME3SB4	MX3SB4	21000	24000	40500	48000	11400	301		
9.6	1390	1.7	149	—	3/A04L2	BE90LA4	BX90LA4	ME3SB4	MX3SB4	21000	24000	40400	47900	11100	289		
10.1	1310	2.7	141	—	3/A05L2	BE90LA4	BX90LA4	ME3SB4	MX3SB4	20600	23500	39700	47100	10900	301		
10.8	1240	1.0	133	—	3/A01L2	BE90LA4	BX90LA4	ME3SB4	MX3SB4	6250	6250	20800	22700	3570	267		
11.1	1200	2.3	129	—	3/A04L2	BE90LA4	BX90LA4	ME3SB4	MX3SB4	20000	22800	38700	45900	10600	289		
12.2	1090	2.2	117	—	3/A04L2	BE90LA4	BX90LA4	ME3SB4	MX3SB4	19300	22100	37600	44500	10300	289		
14.0	950	1.2	102	—	3/A01L2	BE90LA4	BX90LA4	ME3SB4	MX3SB4	5710	5710	19100	20900	3260	267		
14.0	950	2.7	102	—	3/A04L2	BE90LA4	BX90LA4	ME3SB4	MX3SB4	18500	21100	36100	42700	9790	289		
14.8	900	1.9	96.9	—	3/A03L2	BE90LA4	BX90LA4	ME3SB4	MX3SB4	18200	20700	35500	42100	9630	277		
15.8	840	2.8	90.7	—	3/A04L2	BE90LA4	BX90LA4	ME3SB4	MX3SB4	17800	20300	34800	41300	9420	289		
16.2	820	2.0	88.5	—	3/A03L2	BE90LA4	BX90LA4	ME3SB4	MX3SB4	17600	20100	34600	41000	9340	277		
17.6	760	1.7	81.3	—	3/A01L2	BE90LA4	BX90LA4	ME3SB4	MX3SB4	5300	5300	17900	19600	3030	267		
19.3	690	1.7	74.2	—	3/A01L2	BE90LA4	BX90LA4	ME3SB4	MX3SB4	5140	5140	17400	19000	2940	267		
19.5	680	2.6	73.2	—	3/A03L2	BE90LA4	BX90LA4	ME3SB4	MX3SB4	16500	18900	32700	38700	8770	277		
20.1	660	1.0	71.0	—	3/A00L2	BE90LA4	BX90LA4	ME3SB4	MX3SB4	5060	5060	17200	20000	2890	257		
22.7	590	2.6	62.9	—	3/A03L2	BE90LA4	BX90LA4	ME3SB4	MX3SB4	15700	18000	31200	37000	8340	277		
23.4	570	1.1	61.2	—	3/A00L2	BE90LA4	BX90LA4	ME3SB4	MX3SB4	4820	4820	16400	19100	2750	257		
24.1	550	2.3	59.4	—	3/A01L2	BE90LA4	BX90LA4	ME3SB4	MX3SB4	4770	4770	16300	17800	2730	267		
26.4	500	2.3	54.2	—	3/A01L2	BE90LA4	BX90LA4	ME3SB4	MX3SB4	4630	4630	15800	17300	2650	267		
27.6	480	1.1	51.8	—	3/A00L2	BE90LA4	BX90LA4	ME3SB4	MX3SB4	4560	4560	15600	18200	2610	257		
29.1	455	1.8	49.1	—	3/A01L2	BE90LA4	BX90LA4	ME3SB4	MX3SB4	4480	4480	15400	16800	2560	267		
33	410	2.3	43.9	—	3/A01L2	BE90LA4	BX90LA4	ME3SB4	MX3SB4	4320	4320	14900	16300	2470	267		
34	385	1.7	41.5	—	3/A00L2	BE90LA4	BX90LA4	ME3SB4	MX3SB4	4240	4240	14600	17000	2420	257		

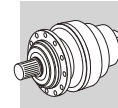

$P_1 = 1.5 \text{ kW}$

n_2 min ⁻¹	M_2 Nm	S	i	3/A00L2		IE2		IE3		Rn_2 [N]					
						IE2	IE3	IE2	IE3	MC/PC	MZ/PZ	HC	HZ	FZ	
36	370	1.5	39.6	—	3/A00L2	BE90LA4	BX90LA4	ME3SB4	MX3SB4	4170	4170	14400	16800	2380	257
36	375	2.3	40.1	—	3/A01L2	BE90LA4	BX90LA4	ME3SB4	MX3SB4	4190	4190	14500	15800	2390	267
40	335	2.3	35.8	—	3/A01L2	BE90LA4	BX90LA4	ME3SB4	MX3SB4	4030	4030	14000	15300	2300	267
45	295	2.2	31.7	—	3/A00L2	BE90LA4	BX90LA4	ME3SB4	MX3SB4	3870	3870	13500	15700	2210	257
61	220	2.7	23.4	—	3/A00L2	BE90LA4	BX90LA4	ME3SB4	MX3SB4	3500	3500	12300	14300	2000	257
75	180	2.6	19.1	—	3/A00L2	BE90LA4	BX90LA4	ME3SB4	MX3SB4	3270	3270	11600	13500	1870	257

$P_1 = 1.5 \text{ kW}$

n_2 min ⁻¹	M_2 Nm	S	i	3/V11ML4		3/V13ML4		3/V10ML4		Rn_2 [N]					
						IE3	IE3	MC/PC	MZ/PZ	HC	HZ	FZ			
0.27	36900	1.3	5326	3/V11ML4	—	BXN90L4	—	—	—	147800	150800	65000	360		
0.28	34100	1.5	5046	3/V13ML4	—	BXN90L4	—	—	—	192000	231000	80000	372		
0.31	30900	1.0	4637	3/V10ML4	—	BXN90L4	—	—	—	115300	146200	65000	348		
0.31	30900	1.0	4637	3/V10ML4	—	BXN90L4	—	—	—	115300	146200	65000	348		
0.32	31000	1.5	4410	3/V11ML4	—	BXN90L4	—	—	—	143900	146800	65000	360		
0.32	31900	1.8	4536	3/V13ML4	—	BXN90L4	—	—	—	192000	231000	80000	372		
0.35	30900	1.0	4036	3/V10ML4	—	BXN90L4	—	—	—	113100	143400	65000	348		
0.35	30900	1.0	4036	3/V10ML4	—	BXN90L4	—	—	—	113100	143400	65000	348		
0.35	27700	1.8	4106	3/V11ML4	—	BXN90L4	—	—	—	142400	145300	65000	360		
0.35	28400	2.1	4046	3/V13ML4	—	BXN90L4	—	—	—	192000	231000	80000	372		
0.40	24800	1.2	3570	3/V10ML4	—	BXN90L4	—	—	—	111100	140900	65000	348		
0.40	24800	1.2	3570	3/V10ML4	—	BXN90L4	—	—	—	111100	140900	65000	348		
0.40	24000	1.8	3557	3/V11ML4	—	BXN90L4	—	—	—	139500	142400	65000	360		
0.41	26900	2.1	3515	3/V13ML4	—	BXN90L4	—	—	—	192000	231000	80000	372		
0.44	25100	1.1	3273	3/V10ML4	—	BXN90L4	—	—	—	109700	139100	65000	348		
0.44	25100	1.1	3273	3/V10ML4	—	BXN90L4	—	—	—	109700	139100	65000	348		
0.44	24700	1.9	3222	3/V11ML4	—	BXN90L4	—	—	—	137600	140400	65000	360		
0.44	25000	2.2	3263	3/V13ML4	—	BXN90L4	—	—	—	192000	231000	80000	372		
0.47	23200	2.1	3063	3/V11ML4	—	BXN90L4	—	—	—	136600	139400	65000	360		
0.48	22900	1.3	2987	3/V10ML4	—	BXN90L4	—	—	—	108300	137300	65000	348		
0.48	22900	1.3	2987	3/V10ML4	—	BXN90L4	—	—	—	108300	137300	65000	348		
0.54	20400	2.3	2663	3/V11ML4	—	BXN90L4	—	—	—	133900	136600	65000	360		
0.58	19000	1.4	2455	3/V10ML4	—	BXN90L4	—	—	—	105300	133500	65000	348		
0.58	19000	1.4	2455	3/V10ML4	—	BXN90L4	—	—	—	105300	133500	65000	348		
0.66	16500	1.7	2156	3/V10ML4	—	BXN90L4	—	—	—	103400	131100	65000	348		
0.66	16500	1.7	2156	3/V10ML4	—	BXN90L4	—	—	—	103400	131100	65000	348		
0.71	15500	1.9	2016	3/V10ML4	—	BXN90L4	—	—	—	102400	129800	65000	348		
0.71	15500	1.9	2016	3/V10ML4	—	BXN90L4	—	—	—	102400	129800	65000	348		
0.73	12900	1.0	1964	3/V07L3	—	BXN90L4	—	39200	49000	88300	116100	45000	324		
0.77	14200	1.9	1855	3/V10ML4	—	BXN90L4	—	—	—	101200	128300	65000	348		
0.77	14200	1.9	1855	3/V10ML4	—	BXN90L4	—	—	—	101200	128300	65000	348		
0.88	12500	2.2	1617	3/V10ML4	—	BXN90L4	—	—	—	99200	125800	65000	348		
0.88	12500	2.2	1617	3/V10ML4	—	BXN90L4	—	—	—	99200	125800	65000	348		
0.93	11000	1.0	1545	3/V07L3	—	BXN90L4	—	37900	47400	85300	112200	45000	324		
1.0	9820	1.3	1411	3/V07L3	—	BXN90L4	—	37400	46800	84200	110800	44100	324		
1.1	8970	1.6	1288	3/V07L3	—	BXN90L4	—	36900	46200	83100	109300	42800	324		
1.2	8240	1.0	1153	3/V06L3	—	BXN90L4	—	30300	34500	69100	79800	32100	312		
1.2	8320	0.9	1212	3/V06L3	—	BXN90L4	—	30500	34800	69600	80300	32600	312		
1.2	8400	1.3	1159	3/V07L3	—	BXN90L4	—	36400	45500	81900	107700	41300	324		
1.4	7090	1.3	992	3/V06L3	—	BXN90L4	—	29700	33800	67600	78100	30500	312		
1.4	7260	2.0	1015	3/V07L3	—	BXN90L4	—	35700	44600	80300	105700	39500	324		
1.5	7350	1.1	930	3/V06L3	—	BXN90L4	—	29400	33500	67000	77300	29800	312		
1.6	6670	1.8	920	3/V07L3	—	BXN90L4	—	35200	44000	79200	104200	38200	324		
1.8	5660	1.4	791	3/V06L3	—	BXN90L4	—	28700	32700	65500	75600	28300	312		
1.8	6110	1.6	773	3/V07L3	—	BXN90L4	—	34300	42900	77300	101600	36100	324		
1.9	5510	2.6	761	3/V07L3	—	BXN90L4	—	34300	42800	77100	101400	35900	324		
2.0	5580	1.4	698	3/V06L3	—	BXN90L4	—	28200	32200	64300	74200	27100	312		
2.1	6120	1.0	671	—	3/A06L2	BXN90L4	—	28000	32000	64000	73800	26800	313		
2.2	5220	1.8	661	3/V06L3	—	BXN90L4	—	28000	31900	63800	73700	26600	312		
2.3	5570	1.1	611	—	3/A06L2	BXN90L4	—	27700	31600	63100	72800	25900	313		
2.3	4510	1.0	623	3/V05L3	—	BXN90L4	—	23300	26600	45000	53300	17900	300		



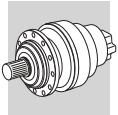

$P_1 = 1.5 \text{ kW}$

n_2 min ⁻¹	M_2 Nm	S	i					R_{n2} [N]					
				MC/PC	MZ/PZ	HC	HZ	FZ					
2.5	4610	1.1	576	3/V05L3	—	BXN90L4	—	23100	26300	44500	52700	17400	300
2.5	4500	1.9	569	3/V06L3	—	BXN90L4	—	27400	31200	62500	72100	25300	312
2.6	5060	1.4	555	—	3/A06L2	BXN90L4	—	27300	31100	62200	71800	25100	313
2.7	4130	0.9	529	3/V05L3	—	BXN90L4	—	22800	26000	43900	52000	17000	300
2.7	4170	1.8	527	3/V06L3	—	BXN90L4	—	27100	30900	61800	71300	24700	312
2.8	4600	1.6	505	—	3/A06L2	BXN90L4	—	26900	30700	61400	70900	24400	313
3.1	3690	1.3	462	3/V05L3	—	BXN90L4	—	22300	25500	43100	51000	16200	300
3.2	3410	1.1	453	3/V04L3	—	BXN90L4	—	22300	25500	43000	50900	16100	288
3.3	3970	2.0	435	—	3/A06L2	BXN90L4	—	26400	30100	60100	69400	23200	313
3.3	4000	2.3	439	—	3/A07L2	BXN90L4	—	31700	39600	71300	93800	29900	325
3.3	3410	2.6	427	3/V06L3	—	BXN90L4	—	26300	30000	59900	69200	23000	312
3.4	3930	1.1	422	—	3/A05L2	BXN90L4	—	22100	25200	42500	50400	15700	301
3.5	3690	2.5	405	—	3/A07L2	BXN90L4	—	31300	39100	70500	92700	29100	325
3.6	3170	1.2	396	3/V05L3	—	BXN90L4	—	21900	25000	42100	50000	15400	300
3.6	3160	2.4	395	3/V06L3	—	BXN90L4	—	26000	29600	59300	68400	22400	312
3.7	3540	1.6	388	—	3/A06L2	BXN90L4	—	25900	29600	59100	68300	22300	313
3.7	2890	1.2	384	3/V04L3	—	BXN90L4	—	21800	24900	41900	49700	15200	288
3.7	3160	2.9	386	3/V07L3	—	BXN90L4	—	31100	38900	70000	92100	28600	324
3.8	3460	1.8	380	—	3/A06L2	BXN90L4	—	25900	29500	59000	68100	22200	313
4.3	3060	1.2	329	—	3/A05L2	BXN90L4	—	21300	24300	41000	48600	14500	301
4.5	2930	2.3	321	—	3/A06L2	BXN90L4	—	25200	28800	57500	66400	20900	313
5.1	2640	1.1	283	—	3/A04L2	BXN90L4	—	21000	24000	40500	48000	13800	289
5.1	2610	1.4	280	—	3/A05L2	BXN90L4	—	21000	24000	40500	48000	13700	301
5.4	2430	2.3	267	—	3/A06L2	BXN90L4	—	25000	28500	57000	65800	19700	313
5.7	2330	1.5	250	—	3/A04L2	BXN90L4	—	21000	24000	40500	48000	13200	289
5.9	2240	1.9	241	—	3/A05L2	BXN90L4	—	21000	24000	40500	48000	13000	301
6.3	2100	1.7	226	—	3/A04L2	BXN90L4	—	21000	24000	40500	48000	12800	289
6.7	1970	1.6	212	—	3/A05L2	BXN90L4	—	21000	24000	40500	48000	12500	301
6.7	1970	1.6	212	—	3/A05L2	BXN90L4	—	21000	24000	40500	48000	12500	301
7.0	1910	1.8	205	—	3/A04L2	BXN90L4	—	21000	24000	40500	48000	12400	289
7.9	1690	1.1	182	—	3/A03L2	BXN90L4	—	21000	24000	40500	48000	11900	277
8.2	1620	1.8	174	—	3/A04L2	BXN90L4	—	21000	24000	40500	48000	11700	289
8.2	1630	2.2	175	—	3/A05L2	BXN90L4	—	21000	24000	40500	48000	11700	301
8.8	1510	1.9	162	—	3/A04L2	BXN90L4	—	21000	24000	40500	48000	11400	289
8.8	1510	1.9	162	—	3/A05L2	BXN90L4	—	21000	24000	40500	48000	11400	301
9.6	1390	1.7	149	—	3/A04L2	BXN90L4	—	21000	24000	40400	47900	11100	289
10.1	1310	2.7	141	—	3/A05L2	BXN90L4	—	20600	23500	39700	47100	10900	301
10.8	1240	1.0	133	—	3/A01L2	BXN90L4	—	6250	6250	20800	22700	3570	267
11.1	1200	2.3	129	—	3/A04L2	BXN90L4	—	20000	22800	38700	45900	10600	289
12.2	1090	2.2	117	—	3/A04L2	BXN90L4	—	19300	22100	37600	44500	10300	289
14.0	950	1.2	102	—	3/A01L2	BXN90L4	—	5710	5710	19100	20900	3260	267
14.0	950	2.7	102	—	3/A04L2	BXN90L4	—	18500	21100	36100	42700	9790	289
14.8	900	1.9	96.9	—	3/A03L2	BXN90L4	—	18200	20700	35500	42100	9630	277
15.8	840	2.8	90.7	—	3/A04L2	BXN90L4	—	17800	20300	34800	41300	9420	289
16.2	820	2.0	88.5	—	3/A03L2	BXN90L4	—	17600	20100	34600	41000	9340	277
17.6	760	1.7	81.3	—	3/A01L2	BXN90L4	—	5300	5300	17900	19600	3030	267
19.3	690	1.7	74.2	—	3/A01L2	BXN90L4	—	5140	5140	17400	19000	2940	267
19.5	680	2.6	73.2	—	3/A03L2	BXN90L4	—	16500	18900	32700	38700	8770	277
20.1	660	1.0	71.0	—	3/A00L2	BXN90L4	—	5060	5060	17200	20000	2890	257
22.7	590	2.6	62.9	—	3/A03L2	BXN90L4	—	15700	18000	31200	37000	8340	277
23.4	570	1.1	61.2	—	3/A00L2	BXN90L4	—	4820	4820	16400	19100	2750	257
24.1	550	2.3	59.4	—	3/A01L2	BXN90L4	—	4770	4770	16300	17800	2730	267
26.4	500	2.3	54.2	—	3/A01L2	BXN90L4	—	4630	4630	15800	17300	2650	267
27.6	480	1.1	51.8	—	3/A00L2	BXN90L4	—	4560	4560	15600	18200	2610	257
29.1	455	1.8	49.1	—	3/A01L2	BXN90L4	—	4480	4480	15400	16800	2560	267
33	410	2.3	43.9	—	3/A01L2	BXN90L4	—	4320	4320	14900	16300	2470	267
34	385	1.7	41.5	—	3/A00L2	BXN90L4	—	4240	4240	14600	17000	2420	257
36	370	1.5	39.6	—	3/A00L2	BXN90L4	—	4170	4170	14400	16800	2380	257
36	375	2.3	40.1	—	3/A01L2	BXN90L4	—	4190	4190	14500	15800	2390	267
40	335	2.3	35.8	—	3/A01L2	BXN90L4	—	4030	4030	14000	15300	2300	267
45	295	2.2	31.7	—	3/A00L2	BXN90L4	—	3870	3870	13500	15700	2210	257
61	220	2.7	23.4	—	3/A00L2	BXN90L4	—	3500	3500	12300	14300	2000	257
75	180	2.6	19.1	—	3/A00L2	BXN90L4	—	3270	3270	11600	13500	1870	257

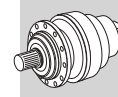

$P_1 = 2.2 \text{ kW}$

n ₂ min ⁻¹	M ₂ Nm	S	i	IE2		IE3		Rn ₂ [N]		MC/PC	MZ/PZ	HC	HZ	FZ	
				BE100LA4	BX100LA4	ME3LA4	MX3LA4	—	—						
0.27	56200	1.6	5234	3/V15ML4	—	BE100LA4	BX100LA4	—	—	—	—	198600	238200	90000	396
0.28	50100	1.0	5046	3/V13ML4	—	BE100LA4	BX100LA4	ME3LA4	MX3LA4	—	—	192000	231000	80000	372
0.29	51200	1.6	4959	3/V14ML4	—	BE100LA4	BX100LA4	—	—	—	—	197100	236300	90000	384
0.29	53100	1.9	4950	3/V15ML4	—	BE100LA4	BX100LA4	—	—	—	—	197000	236300	90000	396
0.29	53100	2.2	4950	3/V16ML4	—	BE100LA4	BX100LA4	—	—	—	—	301500	338200	150000	408
0.32	45600	1.0	4410	3/V11ML4	—	BE100LA4	BX100LA4	ME3LA4	MX3LA4	—	—	143900	146800	65000	360
0.32	46900	1.2	4536	3/V13ML4	—	BE100LA4	BX100LA4	ME3LA4	MX3LA4	—	—	192000	231000	80000	372
0.33	44500	1.8	4312	3/V14ML4	—	BE100LA4	BX100LA4	—	—	—	—	193200	231700	90000	384
0.34	44800	2.3	4171	3/V15ML4	—	BE100LA4	BX100LA4	—	—	—	—	192300	230600	90000	396
0.35	40800	1.2	4106	3/V11ML4	—	BE100LA4	BX100LA4	ME3LA4	MX3LA4	—	—	142400	145300	65000	360
0.35	41800	1.5	4046	3/V13ML4	—	BE100LA4	BX100LA4	ME3LA4	MX3LA4	—	—	192000	231000	80000	372
0.36	44500	1.6	3993	3/V14ML4	—	BE100LA4	BX100LA4	—	—	—	—	191100	229100	90000	384
0.40	35300	1.2	3557	3/V11ML4	—	BE100LA4	BX100LA4	ME3LA4	MX3LA4	—	—	139500	142400	65000	360
0.41	39600	1.4	3515	3/V13ML4	—	BE100LA4	BX100LA4	ME3LA4	MX3LA4	—	—	192000	231000	80000	372
0.44	36300	1.3	3222	3/V11ML4	—	BE100LA4	BX100LA4	ME3LA4	MX3LA4	—	—	137600	140400	65000	360
0.44	36800	1.5	3263	3/V13ML4	—	BE100LA4	BX100LA4	ME3LA4	MX3LA4	—	—	192000	231000	80000	372
0.45	35400	2.2	3182	3/V14ML4	—	BE100LA4	BX100LA4	—	—	—	—	185000	221800	90000	384
0.47	34100	1.4	3063	3/V11ML4	—	BE100LA4	BX100LA4	ME3LA4	MX3LA4	—	—	136600	139400	65000	360
0.51	29900	2.7	2782	3/V14ML4	—	BE100LA4	BX100LA4	—	—	—	—	181400	217600	90000	384
0.52	28600	2.1	2773	3/V13ML4	—	BE100LA4	BX100LA4	ME3LA4	MX3LA4	—	—	192000	228600	80000	372
0.54	30000	1.6	2663	3/V11ML4	—	BE100LA4	BX100LA4	ME3LA4	MX3LA4	—	—	133900	136600	65000	360
0.58	28000	1.0	2455	3/V10ML4	—	BE100LA4	BX100LA4	ME3LA4	MX3LA4	—	—	105300	133500	65000	348
0.58	28000	1.0	2455	3/V10ML4	—	BE100LA4	BX100LA4	ME3LA4	MX3LA4	—	—	105300	133500	65000	348
0.59	24900	1.6	2430	3/V13ML3	—	BE100LA4	BX100LA4	—	—	—	—	191500	224400	80000	372
0.61	23800	1.5	2329	3/V11ML3	—	BE100LA4	BX100LA4	—	—	—	—	131300	134000	65000	360
0.62	23700	2.7	2318	3/V14ML3	—	BE100LA4	BX100LA4	—	—	—	—	176800	212000	90000	384
0.66	24300	1.2	2156	3/V10ML4	—	BE100LA4	BX100LA4	ME3LA4	MX3LA4	—	—	103400	131100	65000	348
0.66	24300	1.2	2156	3/V10ML4	—	BE100LA4	BX100LA4	ME3LA4	MX3LA4	—	—	103400	131100	65000	348
0.71	22700	1.3	2016	3/V10ML4	—	BE100LA4	BX100LA4	ME3LA4	MX3LA4	—	—	102400	129800	65000	348
0.71	22700	1.3	2016	3/V10ML4	—	BE100LA4	BX100LA4	ME3LA4	MX3LA4	—	—	102400	129800	65000	348
0.71	20700	2.8	2019	3/V13ML3	—	BE100LA4	BX100LA4	—	—	—	—	186500	218500	80000	372
0.73	20100	2.1	1963	3/V11ML3	—	BE100LA4	BX100LA4	—	—	—	—	128200	130800	65000	360
0.77	20900	1.3	1855	3/V10ML4	—	BE100LA4	BX100LA4	ME3LA4	MX3LA4	—	—	101200	128300	65000	348
0.77	20900	1.3	1855	3/V10ML4	—	BE100LA4	BX100LA4	ME3LA4	MX3LA4	—	—	101200	128300	65000	348
0.80	17800	1.2	1792	3/V09L3	—	BE100LA4	BX100LA4	—	—	—	—	89100	114600	36000	336
0.87	17200	2.4	1636	3/V11ML3	—	BE100LA4	BX100LA4	—	—	—	—	124900	127400	65000	360
0.88	16200	0.9	1623	3/V09L3	—	BE100LA4	BX100LA4	—	—	—	—	87800	113000	36000	336
0.88	18400	1.5	1617	3/V10ML4	—	BE100LA4	BX100LA4	ME3LA4	MX3LA4	—	—	99200	125800	65000	348
0.88	18400	1.5	1617	3/V10ML4	—	BE100LA4	BX100LA4	ME3LA4	MX3LA4	—	—	99200	125800	65000	348
0.96	15900	1.1	1497	3/V09L3	—	BE100LA4	BX100LA4	—	—	—	—	86800	111700	36000	336
1.0	15000	1.3	1411	3/V10ML3	—	BE100LA4	BX100LA4	—	—	—	—	97300	123400	63700	348
1.1	13200	1.1	1288	3/V07L3	—	BE100LA4	BX100LA4	ME3LA4	MX3LA4	36900	46200	83100	109300	42800	324
1.1	13700	1.6	1288	3/V09L3	—	BE100LA4	BX100LA4	—	—	—	—	85000	109300	34200	336
1.1	13400	2.5	1274	3/V11ML3	—	BE100LA4	BX100LA4	—	—	—	—	120500	123000	61600	360
1.2	12800	1.3	1159	3/V09L3	—	BE100LA4	BX100LA4	—	—	—	—	83700	107700	33000	336
1.2	13100	1.5	1227	3/V10ML3	—	BE100LA4	BX100LA4	—	—	—	—	95400	120900	60800	348
1.3	11900	2.4	1120	3/V10ML3	—	BE100LA4	BX100LA4	—	—	—	—	94200	119400	59000	348
1.4	10400	0.9	992	3/V06L3	—	BE100LA4	BX100LA4	ME3LA4	MX3LA4	29700	33800	67600	78100	30500	312
1.4	10700	1.3	1015	3/V07L3	—	BE100LA4	BX100LA4	ME3LA4	MX3LA4	35700	44600	80300	105700	39500	324
1.4	10700	1.7	1004	3/V09L3	—	BE100LA4	BX100LA4	—	—	—	—	82000	105500	31500	336
1.4	10700	3.0	1004	3/V10ML3	—	BE100LA4	BX100LA4	—	—	—	—	92700	117500	56900	348
1.6	9800	1.3	920	3/V07L3	—	BE100LA4	BX100LA4	ME3LA4	MX3LA4	35200	44000	79200	104200	38200	324
1.6	10200	1.9	920	3/V10ML3	—	BE100LA4	BX100LA4	—	—	—	—	91500	116100	55200	348
1.7	9290	2.2	840	3/V09L3	—	BE100LA4	BX100LA4	—	—	—	—	79900	102900	29700	336
1.8	8310	0.9	791	3/V06L3	—	BE100LA4	BX100LA4	ME3LA4	MX3LA4	28700	32700	65500	75600	28300	312
1.8	8980	1.1	773	3/V07L3	—	BE100LA4	BX100LA4	ME3LA4	MX3LA4	34300	42900	77300	101600	36100	324
1.8	8520	2.5	800	3/V09L3	—	BE100LA4	BX100LA4	—	—	—	—	79400	102200	29200	336
1.9	8100	1.8	761	3/V07L3	—	BE100LA4	BX100LA4	ME3LA4	MX3LA4	34300	42800	77100	101400	35900	324
1.9	8420	1.7	761	3/V09L3	—	BE100LA4	BX100LA4	—	—	—	—	78800	101400	28700	336
2.0	8210	0.9	698	3/V06L3	—	BE100LA4	BX100LA4	ME3LA4	MX3LA4	28200	32200	64300	74200	27100	312
2.2	7680	1.2	661	3/V06L3	—	BE100LA4	BX100LA4	ME3LA4	MX3LA4	28000	31900	63800	73700	26600	312
2.2	6980	2.1	655	3/V07L3	—	BE100LA4	BX100LA4	ME3LA4	MX3LA4	33500	41900	75500	99300	34100	324
2.2	7250	2.4	655	3/V09L3	—	BE100LA4	BX100LA4	—	—	—	—	77100	99300	27300	336
2.5	6610	1.3	569	3/V06L3	—	BE100LA4	BX100LA4	ME3LA4	MX3LA4	27400	31200	62500	72100	25300	312
2.6	7440	1.0	555	—	3/A06L2	BE100LA4	BX100LA4	ME3LA4	MX3LA4	27300	31100	62200	71800	25100	313
2.7	6120	1.2	527	3/V06L3	—	BE100LA4	BX100LA4	ME3LA4	MX3LA4	27100	30900	61800	71300	24700	312

A

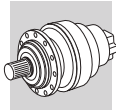

$P_1 = 2.2 \text{ kW}$

n_2 min ⁻¹	M_2 Nm	S	i	3/A06L2		IE2		IE3		R _{n2} [N]					
				3/V07L3	3/V06L3	IE2	IE3	IE2	IE3	MC/PC	MZ/PZ	HC	HZ	FZ	
2.8	6770	1.1	505	—	3/A06L2	BE100LA4	BX100LA4	ME3LA4	MX3LA4	26900	30700	61400	70900	24400	313
2.8	5890	2.3	507	3/V07L3	—	BE100LA4	BX100LA4	ME3LA4	MX3LA4	32300	40400	72800	95700	31400	324
3.1	5340	2.3	460	3/V07L3	—	BE100LA4	BX100LA4	ME3LA4	MX3LA4	31900	39900	71800	94400	30400	324
3.3	5830	1.3	435	—	3/A06L2	BE100LA4	BX100LA4	ME3LA4	MX3LA4	26400	30100	60100	69400	23200	313
3.3	5880	1.6	439	—	3/A07L2	BE100LA4	BX100LA4	ME3LA4	MX3LA4	31700	39600	71300	93800	29900	325
3.3	5020	1.8	427	3/V06L3	—	BE100LA4	BX100LA4	ME3LA4	MX3LA4	26300	30000	59900	69200	23000	312
3.5	5430	1.7	405	—	3/A07L2	BE100LA4	BX100LA4	ME3LA4	MX3LA4	31300	39100	70500	92700	29100	325
3.6	4640	1.6	395	3/V06L3	—	BE100LA4	BX100LA4	ME3LA4	MX3LA4	26000	29600	59300	68400	22400	312
3.7	5200	1.1	388	—	3/A06L2	BE100LA4	BX100LA4	ME3LA4	MX3LA4	25900	29600	59100	68300	22300	313
3.7	4640	1.9	386	3/V07L3	—	BE100LA4	BX100LA4	ME3LA4	MX3LA4	31100	38900	70000	92100	28600	324
3.8	5090	1.2	380	—	3/A06L2	BE100LA4	BX100LA4	ME3LA4	MX3LA4	25900	29500	59000	68100	22200	313
4.2	4570	2.5	341	—	3/A07L2	BE100LA4	BX100LA4	ME3LA4	MX3LA4	30600	38200	68800	90400	27500	325
4.5	4300	1.5	321	—	3/A06L2	BE100LA4	BX100LA4	ME3LA4	MX3LA4	25200	28800	57500	66400	20900	313
5.1	3830	0.9	280	—	3/A05L2	BE100LA4	BX100LA4	ME3LA4	MX3LA4	21000	24000	40500	48000	13700	301
5.1	3780	2.3	282	—	3/A07L2	BE100LA4	BX100LA4	ME3LA4	MX3LA4	30000	37500	67500	88800	25800	325
5.2	3700	2.1	276	—	3/A06L2	BE100LA4	BX100LA4	ME3LA4	MX3LA4	25000	28500	57000	65800	19900	313
5.4	3580	1.5	267	—	3/A06L2	BE100LA4	BX100LA4	ME3LA4	MX3LA4	25000	28500	57000	65800	19700	313
5.7	3420	1.0	250	—	3/A04L2	BE100LA4	BX100LA4	ME3LA4	MX3LA4	21000	24000	40500	48000	13200	289
5.9	3300	1.3	241	—	3/A05L2	BE100LA4	BX100LA4	ME3LA4	MX3LA4	21000	24000	40500	48000	13000	301
5.9	3230	2.8	241	—	3/A07L2	BE100LA4	BX100LA4	ME3LA4	MX3LA4	30000	37500	67500	88800	24500	325
6.3	3090	1.1	226	—	3/A04L2	BE100LA4	BX100LA4	ME3LA4	MX3LA4	21000	24000	40500	48000	12800	289
6.5	2960	2.2	221	—	3/A06L2	BE100LA4	BX100LA4	ME3LA4	MX3LA4	25000	28500	57000	65800	18500	313
6.7	2900	1.1	212	—	3/A05L2	BE100LA4	BX100LA4	ME3LA4	MX3LA4	21000	24000	40500	48000	12500	301
6.7	2900	1.1	212	—	3/A05L2	BE100LA4	BX100LA4	ME3LA4	MX3LA4	21000	24000	40500	48000	12500	301
7.0	2810	1.2	205	—	3/A04L2	BE100LA4	BX100LA4	ME3LA4	MX3LA4	21000	24000	40500	48000	12400	289
7.2	2650	2.1	198	—	3/A06L2	BE100LA4	BX100LA4	ME3LA4	MX3LA4	25000	28500	57000	65800	17800	313
8.2	2380	1.2	174	—	3/A04L2	BE100LA4	BX100LA4	ME3LA4	MX3LA4	21000	24000	40500	48000	11700	289
8.2	2400	1.5	175	—	3/A05L2	BE100LA4	BX100LA4	ME3LA4	MX3LA4	21000	24000	40500	48000	11700	301
8.7	2200	3.0	164	—	3/A06L2	BE100LA4	BX100LA4	ME3LA4	MX3LA4	25000	28500	57000	65800	16700	313
8.8	2220	1.3	162	—	3/A04L2	BE100LA4	BX100LA4	ME3LA4	MX3LA4	21000	24000	40500	48000	11400	289
8.8	2220	1.3	162	—	3/A05L2	BE100LA4	BX100LA4	ME3LA4	MX3LA4	21000	24000	40500	48000	11400	301
9.6	2040	1.2	149	—	3/A04L2	BE100LA4	BX100LA4	ME3LA4	MX3LA4	21000	24000	40400	47900	11100	289
10.1	1930	1.9	141	—	3/A05L2	BE100LA4	BX100LA4	ME3LA4	MX3LA4	20600	23500	39700	47100	10900	301
11.1	1770	1.5	129	—	3/A04L2	BE100LA4	BX100LA4	ME3LA4	MX3LA4	20000	22800	38700	45900	10600	289
11.8	1660	2.1	121	—	3/A05L2	BE100LA4	BX100LA4	ME3LA4	MX3LA4	19600	22300	38000	45000	10400	301
12.2	1600	1.5	117	—	3/A04L2	BE100LA4	BX100LA4	ME3LA4	MX3LA4	19300	22100	37600	44500	10300	289
13.8	1420	2.2	104	—	3/A05L2	BE100LA4	BX100LA4	ME3LA4	MX3LA4	18600	21200	36200	42900	9840	301
14.0	1400	1.8	102	—	3/A04L2	BE100LA4	BX100LA4	ME3LA4	MX3LA4	18500	21100	36100	42700	9790	289
14.8	1330	1.3	96.9	—	3/A03L2	BE100LA4	BX100LA4	ME3LA4	MX3LA4	18200	20700	35500	42100	9630	277
15.8	1240	1.9	90.7	—	3/A04L2	BE100LA4	BX100LA4	ME3LA4	MX3LA4	17800	20300	34800	41300	9420	289
16.2	1210	1.4	88.5	—	3/A03L2	BE100LA4	BX100LA4	ME3LA4	MX3LA4	17600	20100	34600	41000	9340	277
17.5	1120	2.1	81.7	—	3/A04L2	BE100LA4	BX100LA4	ME3LA4	MX3LA4	17200	19600	33800	40000	9100	289
17.6	1110	1.2	81.3	—	3/A01L2	BE100LA4	BX100LA4	ME3LA4	MX3LA4	5300	5300	17900	19600	3030	267
18.9	1040	2.9	75.8	—	3/A05L2	BE100LA4	BX100LA4	ME3LA4	MX3LA4	16700	19100	33000	39100	8870	301
19.3	1020	1.1	74.2	—	3/A01L2	BE100LA4	BX100LA4	ME3LA4	MX3LA4	5140	5140	17400	19000	2940	267
19.5	1000	1.8	73.2	—	3/A03L2	BE100LA4	BX100LA4	ME3LA4	MX3LA4	16500	18900	32700	38700	8770	277
20.9	940	2.7	68.4	—	3/A04L2	BE100LA4	BX100LA4	ME3LA4	MX3LA4	16200	18500	32000	37900	8580	289
22.7	860	1.8	62.9	—	3/A03L2	BE100LA4	BX100LA4	ME3LA4	MX3LA4	15700	18000	31200	37000	8340	277
24.1	810	1.5	59.4	—	3/A01L2	BE100LA4	BX100LA4	ME3LA4	MX3LA4	4770	4770	16300	17800	2730	267
26.4	740	1.6	54.2	—	3/A01L2	BE100LA4	BX100LA4	ME3LA4	MX3LA4	4630	4630	15800	17300	2650	267
27.2	720	2.3	52.5	—	3/A03L2	BE100LA4	BX100LA4	ME3LA4	MX3LA4	14800	16900	29600	35000	7850	277
27.2	720	2.3	52.5	—	3/A03L2	BE100LA4	BX100LA4	ME3LA4	MX3LA4	14800	16900	29600	35000	7850	277
29.1	670	1.2	49.1	—	3/A01L2	BE100LA4	BX100LA4	ME3LA4	MX3LA4	4480	4480	15400	16800	2560	267
33	600	1.5	43.9	—	3/A01L2	BE100LA4	BX100LA4	ME3LA4	MX3LA4	4320	4320	14900	16300	2470	267
34	570	1.1	41.5	—	3/A00L2	BE100LA4	BX100LA4	ME3LA4	MX3LA4	4240	4240	14600	17000	2420	257
35	550	3.0	40.5	—	3/A03L2	BE100LA4	BX100LA4	ME3LA4	MX3LA4	13600	15500	27300	32400	7200	277
36	540	1.0	39.6	—	3/A00L2	BE100LA4	BX100LA4	ME3LA4	MX3LA4	4170	4170	14400	16800	2380	257
36	550	1.6	40.1	—	3/A01L2	BE100LA4	BX100LA4	ME3LA4	MX3LA4	4190	4190	14500	15800	2390	267
40	490	1.6	35.8	—	3/A01L2	BE100LA4	BX100LA4	ME3LA4	MX3LA4	4030	4030	14000	15300	2300	267
45	435	1.5	31.7	—	3/A00L2	BE100LA4	BX100LA4	ME3LA4	MX3LA4	3870	3870	13500	15700	2210	257
46	425	2.8	31.2	—	3/A01L2	BE100LA4	BX100LA4	ME3LA4	MX3LA4	3850	3850	13400	14700	2200	267
61	320	1.8	23.4	—	3/A00L2	BE100LA4	BX100LA4	ME3LA4	MX3LA4	3500	3500	12300	14300	2000	257
62	315	2.8	23.0	—	3/A01L2	BE100LA4	BX100LA4	ME3LA4	MX3LA4	3480	3480	12300	13400	1990	267
75	260	1.8	19.1	—	3/A00L2	BE100LA4	BX100LA4	ME3LA4	MX3LA4	3270	3270	11600	13500	1870	257
76	255	2.8	18.8	—	3/A01L2	BE100LA4	BX100LA4	ME3LA4	MX3LA4	3250	3250	11500	12600	1860	267

A

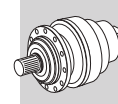

$P_1 = 3 \text{ kW}$

n_2 min ⁻¹	M_2 Nm	S	i	IE2		IE3		IE2		IE3		R _{n2} [N]					
				MC/PC	MZ/PZ	HC	HZ	FZ									
0.27	76400	1.2	5234	3/V15ML4	—	BE100LB4	BX100LB4	—	—	—	—	—	—	198600	238200	90000	396
0.29	69700	1.2	4959	3/V14ML4	—	BE100LB4	BX100LB4	—	—	—	—	—	—	197100	236300	90000	384
0.29	72300	1.4	4950	3/V15ML4	—	BE100LB4	BX100LB4	—	—	—	—	—	—	197000	236300	90000	396
0.29	72300	1.6	4950	3/V16ML4	—	BE100LB4	BX100LB4	—	—	—	—	—	—	301500	338200	150000	408
0.33	60600	1.3	4312	3/V14ML4	—	BE100LB4	BX100LB4	—	—	—	—	—	—	193200	231700	90000	384
0.34	60900	1.7	4171	3/V15ML4	—	BE100LB4	BX100LB4	—	—	—	—	—	—	192300	230600	90000	396
0.34	60900	2.2	4171	3/V16ML4	—	BE100LB4	BX100LB4	—	—	—	—	—	—	294200	330000	150000	408
0.35	56900	1.1	4046	3/V13ML4	—	BE100LB4	BX100LB4	ME3LB4	MX3LB4	—	—	—	—	192000	231000	80000	372
0.36	60500	1.2	3993	3/V14ML4	—	BE100LB4	BX100LB4	—	—	—	—	—	—	191100	229100	90000	384
0.40	53900	1.1	3515	3/V13ML4	—	BE100LB4	BX100LB4	ME3LB4	MX3LB4	—	—	—	—	192000	231000	80000	372
0.40	51300	2.6	3514	3/V16ML4	—	BE100LB4	BX100LB4	—	—	—	—	—	—	287100	322100	150000	408
0.44	49400	1.0	3222	3/V11ML4	—	BE100LB4	BX100LB4	ME3LB4	MX3LB4	—	—	—	—	137600	140400	65000	360
0.44	50000	1.1	3263	3/V13ML4	—	BE100LB4	BX100LB4	ME3LB4	MX3LB4	—	—	—	—	192000	231000	80000	372
0.45	48200	1.6	3182	3/V14ML4	—	BE100LB4	BX100LB4	—	—	—	—	—	—	185000	221800	90000	384
0.46	46400	1.0	3063	3/V11ML4	—	BE100LB4	BX100LB4	ME3LB4	MX3LB4	—	—	—	—	136600	139400	65000	360
0.49	42100	2.9	2880	3/V16ML4	—	BE100LB4	BX100LB4	—	—	—	—	—	—	279000	313000	150000	408
0.51	39000	1.5	2773	3/V13ML4	—	BE100LB4	BX100LB4	ME3LB4	MX3LB4	—	—	—	—	192000	228600	80000	372
0.51	40600	2.0	2782	3/V14ML4	—	BE100LB4	BX100LB4	—	—	—	—	—	—	181400	217600	90000	384
0.53	40800	1.2	2663	3/V11ML4	—	BE100LB4	BX100LB4	ME3LB4	MX3LB4	—	—	—	—	133900	136600	65000	360
0.53	39100	2.9	2678	3/V16ML4	—	BE100LB4	BX100LB4	—	—	—	—	—	—	276200	309800	150000	408
0.57	35200	2.3	2504	3/V14ML4	—	BE100LB4	BX100LB4	—	—	—	—	—	—	178700	214300	90000	384
0.58	33800	1.2	2430	3/V13ML3	—	BE100LB4	BX100LB4	—	—	—	—	—	—	191500	224400	80000	372
0.61	32400	1.1	2329	3/V11ML3	—	BE100LB4	BX100LB4	—	—	—	—	—	—	131300	134000	65000	360
0.61	32300	2.0	2318	3/V14ML3	—	BE100LB4	BX100LB4	—	—	—	—	—	—	176800	212000	90000	384
0.70	30900	1.0	2016	3/V10ML4	—	BE100LB4	BX100LB4	ME3LB4	MX3LB4	—	—	—	—	102400	129800	65000	348
0.70	30900	1.0	2016	3/V10ML4	—	BE100LB4	BX100LB4	ME3LB4	MX3LB4	—	—	—	—	102400	129800	65000	348
0.70	28100	2.0	2019	3/V13ML3	—	BE100LB4	BX100LB4	—	—	—	—	—	—	186500	218500	80000	372
0.71	27800	2.6	1994	3/V14ML3	—	BE100LB4	BX100LB4	—	—	—	—	—	—	173000	207500	90000	384
0.72	27300	1.5	1963	3/V11ML3	—	BE100LB4	BX100LB4	—	—	—	—	—	—	128200	130800	65000	360
0.77	28400	1.0	1855	3/V10ML4	—	BE100LB4	BX100LB4	ME3LB4	MX3LB4	—	—	—	—	101200	128300	65000	348
0.77	28400	1.0	1855	3/V10ML4	—	BE100LB4	BX100LB4	ME3LB4	MX3LB4	—	—	—	—	101200	128300	65000	348
0.79	24300	0.9	1792	3/V09L3	—	BE100LB4	BX100LB4	—	—	—	—	—	—	89100	114600	36000	336
0.84	24100	2.4	1682	3/V13ML3	—	BE100LB4	BX100LB4	—	—	—	—	—	—	181700	212900	80000	372
0.87	23400	1.8	1636	3/V11ML3	—	BE100LB4	BX100LB4	—	—	—	—	—	—	124900	127400	65000	360
0.88	25100	1.1	1617	3/V10ML4	—	BE100LB4	BX100LB4	ME3LB4	MX3LB4	—	—	—	—	99200	125800	65000	348
0.88	25100	1.1	1617	3/V10ML4	—	BE100LB4	BX100LB4	ME3LB4	MX3LB4	—	—	—	—	99200	125800	65000	348
0.89	22100	2.6	1589	3/V14ML3	—	BE100LB4	BX100LB4	—	—	—	—	—	—	167500	200900	90000	384
1.0	20400	1.0	1411	3/V10ML3	—	BE100LB4	BX100LB4	—	—	—	—	—	—	97300	123400	63000	348
1.0	19700	2.4	1378	3/V11ML3	—	BE100LB4	BX100LB4	—	—	—	—	—	—	121800	124300	63200	360
1.0	20300	2.8	1418	3/V13ML3	—	BE100LB4	BX100LB4	—	—	—	—	—	—	177300	207700	78500	372
1.1	18700	1.2	1288	3/V09L3	—	BE100LB4	BX100LB4	—	—	—	—	—	—	85000	109300	34200	336
1.1	18200	1.8	1274	3/V11ML3	—	BE100LB4	BX100LB4	—	—	—	—	—	—	120500	123000	61600	360
1.1	18500	2.7	1291	3/V13ML3	—	BE100LB4	BX100LB4	—	—	—	—	—	—	174900	205000	76100	372
1.1	18600	2.6	1339	3/V14ML3	—	BE100LB4	BX100LB4	—	—	—	—	—	—	163400	196000	86700	384
1.2	17400	0.9	1159	3/V09L3	—	BE100LB4	BX100LB4	—	—	—	—	—	—	83700	107700	33000	336
1.2	17800	1.1	1227	3/V10ML3	—	BE100LB4	BX100LB4	—	—	—	—	—	—	95400	120900	60800	348
1.3	16200	1.8	1120	3/V10ML3	—	BE100LB4	BX100LB4	—	—	—	—	—	—	94200	119400	59000	348
1.4	14500	1.0	1015	3/V07L3	—	BE100LB4	BX100LB4	ME3LB4	MX3LB4	35700	44600	80300	105700	39500	39500	324	
1.4	14500	1.2	1004	3/V09L3	—	BE100LB4	BX100LB4	—	—	—	—	—	—	82000	105500	31500	336
1.4	14500	2.2	1004	3/V10ML3	—	BE100LB4	BX100LB4	—	—	—	—	—	—	92700	117500	56900	348
1.4	14000	2.6	1004	3/V11ML3	—	BE100LB4	BX100LB4	—	—	—	—	—	—	116500	118800	56900	360
1.5	13300	0.9	920	3/V07L3	—	BE100LB4	BX100LB4	ME3LB4	MX3LB4	35200	44000	79200	104200	38200	38200	324	
1.5	13900	1.4	920	3/V10ML3	—	BE100LB4	BX100LB4	—	—	—	—	—	—	91500	116100	55200	348
1.7	12600	1.6	840	3/V09L3	—	BE100LB4	BX100LB4	—	—	—	—	—	—	79900	102900	29700	336
1.8	11600	1.8	800	3/V09L3	—	BE100LB4	BX100LB4	—	—	—	—	—	—	79400	102200	29200	336
1.9	11000	1.3	761	3/V07L3	—	BE100LB4	BX100LB4	ME3LB4	MX3LB4	34300	42800	77100	101400	35900	35900	324	
1.9	11500	1.3	761	3/V09L3	—	BE100LB4	BX100LB4	—	—	—	—	—	—	78800	101400	28700	336
2.2	9490	1.5	655	3/V07L3	—	BE100LB4	BX100LB4	ME3LB4	MX3LB4	33500	41900	75500	99300	34100	34100	324	
2.2	9860	1.8	655	3/V09L3	—	BE100LB4	BX100LB4	—	—	—	—	—	—	77100	99300	27300	336
2.5	8990	1.0	569	3/V06L3	—	BE100LB4	BX100LB4	ME3LB4	MX3LB4	27400	31200	62500	72100	25300	25300	312	
2.7	8330	0.9	527	3/V06L3	—	BE100LB4	BX100LB4	ME3LB4	MX3LB4	27100	30900	61800	71300	24700	24700	312	
2.8	8010	1.7	507	3/V07L3	—	BE100LB4	BX100LB4	ME3LB4	MX3LB4	32300	40400	72800	95700	31400	31400	324	
3.1	7270	1.7	460	3/V07L3	—	BE100LB4	BX100LB4	ME3LB4	MX3LB4	31900	39900	71800	94400	30400	30400	324	
3.2	8010	1.1	439	—	3/A07L2	BE100LB4	BX100LB4	ME3LB4	MX3LB4	31700	39600	71300	93800	29900	29900	325	
3.2	6650	2.7	442	3/V09L3	—	BE100LB4	BX100LB4	—	—	—	—	—	—	72900	93800	24000	336
3.3	7930	1.0	435	—	3/A06L2	BE100LB4	BX100LB4	ME3LB4	MX3LB4	26400	30100	60100	69400	23200	23200	313	

A

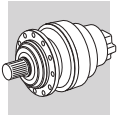

$P_1 = 3 \text{ kW}$

n ₂ min ⁻¹	M ₂ Nm	S	i	3/V06L3		3/V07L3		3/V09L3		Rn ₂ [N]					Icon
				IE2	IE3	IE2	IE3	MC/PC	MZ/PZ	HC	HZ	FZ			
3.3	6830	1.3	427	3/V06L3	—	BE100LB4	BX100LB4	ME3LB4	MX3LB4	26300	30000	59900	69200	23000	312
3.5	7390	1.2	405	—	3/A07L2	BE100LB4	BX100LB4	ME3LB4	MX3LB4	31300	39100	70500	92700	29100	325
3.6	6320	1.2	395	3/V06L3	—	BE100LB4	BX100LB4	ME3LB4	MX3LB4	26000	29600	59300	68400	22400	312
3.7	6320	1.4	386	3/V07L3	—	BE100LB4	BX100LB4	ME3LB4	MX3LB4	31100	38900	70000	92100	28600	324
3.8	5570	2.3	370	3/V09L3	—	BE100LB4	BX100LB4	—	—	—	—	71100	91500	22600	336
4.2	6220	1.8	341	—	3/A07L2	BE100LB4	BX100LB4	ME3LB4	MX3LB4	30600	38200	68800	90400	27500	325
4.4	5850	1.1	321	—	3/A06L2	BE100LB4	BX100LB4	ME3LB4	MX3LB4	25200	28800	57500	66400	20900	313
5.0	5140	1.7	282	—	3/A07L2	BE100LB4	BX100LB4	ME3LB4	MX3LB4	30000	37500	67500	88800	25800	325
5.1	5030	1.5	276	—	3/A06L2	BE100LB4	BX100LB4	ME3LB4	MX3LB4	25000	28500	57000	65800	19900	313
5.3	4870	1.1	267	—	3/A06L2	BE100LB4	BX100LB4	ME3LB4	MX3LB4	25000	28500	57000	65800	19700	313
5.9	4490	1.0	241	—	3/A05L2	BE100LB4	BX100LB4	ME3LB4	MX3LB4	21000	24000	40500	48000	13000	301
5.9	4390	2.0	241	—	3/A07L2	BE100LB4	BX100LB4	ME3LB4	MX3LB4	30000	37500	67500	88800	24500	325
6.4	4030	1.6	221	—	3/A06L2	BE100LB4	BX100LB4	ME3LB4	MX3LB4	25000	28500	57000	65800	18500	313
6.4	4070	2.2	223	—	3/A07L2	BE100LB4	BX100LB4	ME3LB4	MX3LB4	30000	37500	67500	88800	23800	325
6.9	3820	0.9	205	—	3/A04L2	BE100LB4	BX100LB4	ME3LB4	MX3LB4	21000	24000	40500	48000	12400	289
7.2	3610	1.5	198	—	3/A06L2	BE100LB4	BX100LB4	ME3LB4	MX3LB4	25000	28500	57000	65800	17800	313
7.2	3610	2.4	198	—	3/A07L2	BE100LB4	BX100LB4	ME3LB4	MX3LB4	30000	37500	67500	88800	22900	325
7.5	3460	2.2	190	—	3/A06L2	BE100LB4	BX100LB4	ME3LB4	MX3LB4	25000	28500	57000	65800	17600	313
8.1	3260	1.1	175	—	3/A05L2	BE100LB4	BX100LB4	ME3LB4	MX3LB4	21000	24000	40500	48000	11700	301
8.2	3240	0.9	174	—	3/A04L2	BE100LB4	BX100LB4	ME3LB4	MX3LB4	21000	24000	40500	48000	11700	289
8.7	2990	2.2	164	—	3/A06L2	BE100LB4	BX100LB4	ME3LB4	MX3LB4	25000	28500	57000	65800	16700	313
8.8	3020	1.0	162	—	3/A04L2	BE100LB4	BX100LB4	ME3LB4	MX3LB4	21000	24000	40500	48000	11400	289
8.8	3020	1.0	162	—	3/A05L2	BE100LB4	BX100LB4	ME3LB4	MX3LB4	21000	24000	40500	48000	11400	301
10.1	2630	1.4	141	—	3/A05L2	BE100LB4	BX100LB4	ME3LB4	MX3LB4	20600	23500	39700	47100	10900	301
11.0	2400	1.1	129	—	3/A04L2	BE100LB4	BX100LB4	ME3LB4	MX3LB4	20000	22800	38700	45900	10600	289
11.4	2330	2.3	125	—	3/A06L2	BE100LB4	BX100LB4	ME3LB4	MX3LB4	23500	26800	53900	62200	15300	313
11.7	2250	1.6	121	—	3/A05L2	BE100LB4	BX100LB4	ME3LB4	MX3LB4	19600	22300	38000	45000	10400	301
12.1	2180	1.1	117	—	3/A04L2	BE100LB4	BX100LB4	ME3LB4	MX3LB4	19300	22100	37600	44500	10300	289
13.7	1940	1.6	104	—	3/A05L2	BE100LB4	BX100LB4	ME3LB4	MX3LB4	18600	21200	36200	42900	9840	301
13.9	1900	1.3	102	—	3/A04L2	BE100LB4	BX100LB4	ME3LB4	MX3LB4	18500	21100	36100	42700	9790	289
14.4	1830	2.9	98.3	—	3/A06L2	BE100LB4	BX100LB4	ME3LB4	MX3LB4	21700	24800	50200	58000	14100	313
14.7	1800	0.9	96.9	—	3/A03L2	BE100LB4	BX100LB4	ME3LB4	MX3LB4	18200	20700	35500	42100	9630	277
15.7	1690	1.4	90.7	—	3/A04L2	BE100LB4	BX100LB4	ME3LB4	MX3LB4	17800	20300	34800	41300	9420	289
16.0	1650	1.0	88.5	—	3/A03L2	BE100LB4	BX100LB4	ME3LB4	MX3LB4	17600	20100	34600	41000	9340	277
16.6	1590	2.2	85.6	—	3/A05L2	BE100LB4	BX100LB4	ME3LB4	MX3LB4	17400	19900	34200	40600	9240	301
17.4	1520	1.6	81.7	—	3/A04L2	BE100LB4	BX100LB4	ME3LB4	MX3LB4	17200	19600	33800	40000	9100	289
18.7	1410	2.2	75.8	—	3/A05L2	BE100LB4	BX100LB4	ME3LB4	MX3LB4	16700	19100	33000	39100	8870	301
19.4	1360	1.3	73.2	—	3/A03L2	BE100LB4	BX100LB4	ME3LB4	MX3LB4	16500	18900	32700	38700	8770	277
19.6	1350	2.5	72.5	—	3/A05L2	BE100LB4	BX100LB4	ME3LB4	MX3LB4	16500	18800	32600	38600	8740	301
20.8	1270	2.0	68.4	—	3/A04L2	BE100LB4	BX100LB4	ME3LB4	MX3LB4	16200	18500	32000	37900	8580	289
22.6	1170	1.3	62.9	—	3/A03L2	BE100LB4	BX100LB4	ME3LB4	MX3LB4	15700	18000	31200	37000	8340	277
22.7	1170	2.8	62.6	—	3/A05L2	BE100LB4	BX100LB4	ME3LB4	MX3LB4	15700	17900	31200	36900	8330	301
22.8	1160	2.5	62.4	—	3/A04L2	BE100LB4	BX100LB4	ME3LB4	MX3LB4	15700	17900	31100	36900	8320	289
23.9	1110	1.1	59.4	—	3/A01L2	BE100LB4	BX100LB4	ME3LB4	MX3LB4	4770	4770	16300	17800	2730	267
26.1	1020	2.4	54.5	—	3/A04L2	BE100LB4	BX100LB4	ME3LB4	MX3LB4	15000	17100	29900	35400	7950	289
26.2	1010	1.2	54.2	—	3/A01L2	BE100LB4	BX100LB4	ME3LB4	MX3LB4	4630	4630	15800	17300	2650	267
27.0	980	1.7	52.5	—	3/A03L2	BE100LB4	BX100LB4	ME3LB4	MX3LB4	14800	16900	29600	35000	7850	277
27.0	980	1.7	52.5	—	3/A03L2	BE100LB4	BX100LB4	ME3LB4	MX3LB4	14800	16900	29600	35000	7850	277
28.6	930	2.5	49.7	—	3/A04L2	BE100LB4	BX100LB4	ME3LB4	MX3LB4	14500	16600	29100	34500	7710	289
28.9	910	0.9	49.1	—	3/A01L2	BE100LB4	BX100LB4	ME3LB4	MX3LB4	4480	4480	15400	16800	2560	267
32	820	1.1	43.9	—	3/A01L2	BE100LB4	BX100LB4	ME3LB4	MX3LB4	4320	4320	14900	16300	2470	267
33	810	2.2	43.4	—	3/A03L2	BE100LB4	BX100LB4	ME3LB4	MX3LB4	13900	15900	27900	33100	7370	277
35	750	1.2	40.1	—	3/A01L2	BE100LB4	BX100LB4	ME3LB4	MX3LB4	4190	4190	14500	15800	2390	267
35	750	2.2	40.5	—	3/A03L2	BE100LB4	BX100LB4	ME3LB4	MX3LB4	13600	15500	27300	32400	7200	277
40	670	1.1	35.8	—	3/A01L2	BE100LB4	BX100LB4	ME3LB4	MX3LB4	4030	4030	14000	15300	2300	267
42	620	2.9	33.5	—	3/A03L2	BE100LB4	BX100LB4	ME3LB4	MX3LB4	12700	14600	25800	30600	6760	277
45	590	1.1	31.7	—	3/A00L2	BE100LB4	BX100LB4	ME3LB4	MX3LB4	3870	3870	13500	15700	2210	257
46	580	2.0	31.2	—	3/A01L2	BE100LB4	BX100LB4	ME3LB4	MX3LB4	3850	3850	13400	14700	2200	267
49	540	2.9	28.8	—	3/A03L2	BE100LB4	BX100LB4	ME3LB4	MX3LB4	12100	13800	24700	29300	6430	277
61	435	1.3	23.4	—	3/A00L2	BE100LB4	BX100LB4	ME3LB4	MX3LB4	3500	3500	12300	14300	2000	257
62	430	2.0	23.0	—	3/A01L2	BE100LB4	BX100LB4	ME3LB4	MX3LB4	3480	3480	12300	13400	1990	267
62	430	2.9	23.0	—	3/A03L2	BE100LB4	BX100LB4	ME3LB4	MX3LB4	11200	12800	23100	27300	5960	277
73	360	2.9	19.4	—	3/A03L2	BE100LB4	BX100LB4	ME3LB4	MX3LB4	10600	12100	21900	26000	5640	277
74	355	1.3	19.1	—	3/A00L2	BE100LB4	BX100LB4	ME3LB4	MX3LB4	3270	3270	11600	13500	1870	257
76	350	2.0	18.8	—	3/A01L2	BE100LB4	BX100LB4	ME3LB4	MX3LB4	3250	3250	11500	12600	1860	267

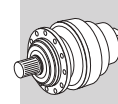

$P_1 = 4 \text{ kW}$

n ₂ min ⁻¹	M ₂ Nm	S	i	Motor Type		IE2		IE3		Rn ₂ [N]					Icon
				BE	BX	IE2	IE3	MC/PC	MZ/PZ	HC	HZ	FZ			
0.29	97600	1.0	4950	3/V15ML4	—	BE112M4	BX112M4	—	—	—	—	197000	236300	90000	396
0.29	97600	1.2	4950	3/V16ML4	—	BE112M4	BX112M4	—	—	—	—	301500	338200	150000	408
0.32	83300	2.4	4449	3/V17ML4	—	BE112M4	BX112M4	—	—	—	—	442000	470000	150000	418
0.33	81800	1.0	4312	3/V14ML4	—	BE112M4	BX112M4	—	—	—	—	193200	231700	90000	384
0.35	82200	1.2	4171	3/V15ML4	—	BE112M4	BX112M4	—	—	—	—	192300	230600	90000	396
0.35	82200	1.6	4171	3/V16ML4	—	BE112M4	BX112M4	—	—	—	—	294200	330000	150000	408
0.41	69300	1.9	3514	3/V16ML4	—	BE112M4	BX112M4	—	—	—	—	287100	322100	150000	408
0.45	65100	1.2	3182	3/V14ML4	—	BE112M4	BX112M4	—	—	—	—	185000	221800	90000	384
0.50	56800	2.1	2880	3/V16ML4	—	BE112M4	BX112M4	—	—	—	—	279000	313000	150000	408
0.52	52600	1.1	2773	3/V13ML4	—	BE112M4	BX112M4	ME4SA4	MX4SA4	—	—	192000	228600	80000	372
0.52	54800	1.5	2782	3/V14ML4	—	BE112M4	BX112M4	—	—	—	—	181400	217600	90000	384
0.54	52800	2.1	2678	3/V16ML4	—	BE112M4	BX112M4	—	—	—	—	276200	309800	150000	408
0.58	47500	1.7	2504	3/V14ML4	—	BE112M4	BX112M4	—	—	—	—	178700	214300	90000	384
0.62	43600	1.5	2318	3/V14ML3	—	BE112M4	BX112M4	—	—	—	—	176800	212000	90000	384
0.71	38000	1.5	2019	3/V13ML3	—	BE112M4	BX112M4	—	—	—	—	186500	218500	80000	372
0.72	37500	1.9	1994	3/V14ML3	—	BE112M4	BX112M4	—	—	—	—	173000	207500	90000	384
0.73	36900	1.1	1963	3/V11ML3	—	BE112M4	BX112M4	—	—	—	—	128200	130800	65000	360
0.86	32500	1.8	1682	3/V13ML3	—	BE112M4	BX112M4	—	—	—	—	181700	212900	80000	372
0.87	32100	2.3	1662	3/V14ML3	—	BE112M4	BX112M4	—	—	—	—	168600	202200	90000	384
0.88	31600	1.3	1636	3/V11ML3	—	BE112M4	BX112M4	—	—	—	—	124900	127400	65000	360
0.91	29900	1.9	1589	3/V14ML3	—	BE112M4	BX112M4	—	—	—	—	167500	200900	90000	384
1.0	26600	1.8	1378	3/V11ML3	—	BE112M4	BX112M4	—	—	—	—	121800	124300	63200	360
1.0	27400	2.1	1418	3/V13ML3	—	BE112M4	BX112M4	—	—	—	—	177300	207700	78500	372
1.1	24600	1.3	1274	3/V11ML3	—	BE112M4	BX112M4	—	—	—	—	120500	123000	61600	360
1.1	24900	2.0	1291	3/V13ML3	—	BE112M4	BX112M4	—	—	—	—	174900	205000	76100	372
1.1	25600	2.4	1324	3/V14ML3	—	BE112M4	BX112M4	—	—	—	—	163200	195700	86300	384
1.1	25200	1.9	1339	3/V14ML3	—	BE112M4	BX112M4	—	—	—	—	163400	196000	86700	384
1.3	21900	1.3	1120	3/V10ML3	—	BE112M4	BX112M4	—	—	—	—	94200	119400	59000	348
1.3	21000	2.4	1088	3/V13ML3	—	BE112M4	BX112M4	—	—	—	—	170700	200000	71900	372
1.3	21500	2.4	1116	3/V14ML3	—	BE112M4	BX112M4	—	—	—	—	159200	191000	81500	384
1.4	19600	0.9	1004	3/V09L3	—	BE112M4	BX112M4	—	—	—	—	82000	105500	31500	336
1.4	19600	1.6	1004	3/V10ML3	—	BE112M4	BX112M4	—	—	—	—	92700	117500	56900	348
1.4	18900	1.9	1004	3/V11ML3	—	BE112M4	BX112M4	—	—	—	—	116500	118800	56900	360
1.6	18700	1.0	920	3/V10ML3	—	BE112M4	BX112M4	—	—	—	—	91500	116100	55200	348
1.6	17400	2.4	900	3/V11ML3	—	BE112M4	BX112M4	—	—	—	—	114700	117000	54800	360
1.7	17100	1.2	840	3/V09L3	—	BE112M4	BX112M4	—	—	—	—	79900	102900	29700	336
1.8	15600	1.4	800	3/V09L3	—	BE112M4	BX112M4	—	—	—	—	79400	102200	29200	336
1.9	14900	1.0	761	3/V07L3	—	BE112M4	BX112M4	ME4SA4	MX4SA4	34300	42800	77100	101400	35900	324
1.9	15500	0.9	761	3/V09L3	—	BE112M4	BX112M4	—	—	—	—	78800	101400	28700	336
2.2	12800	1.1	655	3/V07L3	—	BE112M4	BX112M4	ME4SA4	MX4SA4	33500	41900	75500	99300	34100	324
2.2	13300	1.3	655	3/V09L3	—	BE112M4	BX112M4	—	—	—	—	77100	99300	27300	336
2.8	10800	1.3	507	3/V07L3	—	BE112M4	BX112M4	ME4SA4	MX4SA4	32300	40400	72800	95700	31400	324
3.1	9820	1.3	460	3/V07L3	—	BE112M4	BX112M4	ME4SA4	MX4SA4	31900	39900	71800	94400	30400	324
3.3	8980	2.0	442	3/V09L3	—	BE112M4	BX112M4	—	—	—	—	72900	93800	24000	336
3.4	9220	1.0	427	3/V06L3	—	BE112M4	BX112M4	ME4SA4	MX4SA4	26300	30000	59900	69200	23000	312
3.6	9970	0.9	405	—	3/A07L2	BE112M4	BX112M4	ME4SA4	MX4SA4	31300	39100	70500	92700	29100	325
3.7	8530	1.1	386	3/V07L3	—	BE112M4	BX112M4	ME4SA4	MX4SA4	31100	38900	70000	92100	28600	324
3.9	7520	1.7	370	3/V09L3	—	BE112M4	BX112M4	—	—	—	—	71100	91500	22600	336
4.2	8390	1.4	341	—	3/A07L2	BE112M4	BX112M4	ME4SA4	MX4SA4	30600	38200	68800	90400	27500	325
5.1	6940	1.3	282	—	3/A07L2	BE112M4	BX112M4	ME4SA4	MX4SA4	30000	37500	67500	88800	25800	325
5.2	6790	1.1	276	—	3/A06L2	BE112M4	BX112M4	ME4SA4	MX4SA4	25000	28500	57000	65800	19900	313
6.0	5930	1.5	241	—	3/A07L2	BE112M4	BX112M4	ME4SA4	MX4SA4	30000	37500	67500	88800	24500	325
6.5	5440	1.2	221	—	3/A06L2	BE112M4	BX112M4	ME4SA4	MX4SA4	25000	28500	57000	65800	18500	313
6.5	5490	1.6	223	—	3/A07L2	BE112M4	BX112M4	ME4SA4	MX4SA4	30000	37500	67500	88800	23800	325
7.3	4870	1.1	198	—	3/A06L2	BE112M4	BX112M4	ME4SA4	MX4SA4	25000	28500	57000	65800	17800	313
7.3	4870	1.8	198	—	3/A07L2	BE112M4	BX112M4	ME4SA4	MX4SA4	30000	37500	67500	88800	22900	325
7.6	4680	1.7	190	—	3/A06L2	BE112M4	BX112M4	ME4SA4	MX4SA4	25000	28500	57000	65800	17600	313
8.0	4430	2.5	180	—	3/A07L2	BE112M4	BX112M4	ME4SA4	MX4SA4	30000	37500	67500	88800	22200	325
8.8	4040	1.6	164	—	3/A06L2	BE112M4	BX112M4	ME4SA4	MX4SA4	25000	28500	57000	65800	16700	313
9.3	3820	2.4	155	—	3/A07L2	BE112M4	BX112M4	ME4SA4	MX4SA4	30000	37500	67500	88800	21100	325
10.2	3550	1.0	141	—	3/A05L2	BE112M4	BX112M4	ME4SA4	MX4SA4	20600	23500	39700	47100	10900	301
10.2	3470	2.2	141	—	3/A06L2	BE112M4	BX112M4	ME4SA4	MX4SA4	24500	27900	55900	64600	15900	313
11.5	3140	1.7	125	—	3/A06L2	BE112M4	BX112M4	ME4SA4	MX4SA4	23500	26800	53900	62200	15300	313
11.9	3040	1.2	121	—	3/A05L2	BE112M4	BX112M4	ME4SA4	MX4SA4	19600	22300	38000	45000	10400	301
12.9	2760	2.2	112	—	3/A06L2	BE112M4	BX112M4	ME4SA4	MX4SA4	22700	25900	52200	60300	14700	313

A

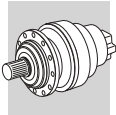

$P_1 = 4 \text{ kW}$

n_2 min ⁻¹	M_2 Nm	S	i	IE2		IE3		IE2		IE3		Rn_2 [N]					
				MC/PC	MZ/PZ	HC	HZ	FZ									
13.8	2610	1.2	104	—	3/A05L2	BE112M4	BX112M4	ME4SA4	MX4SA4	18600	21200	36200	42900	9840	301		
14.1	2560	1.0	102	—	3/A04L2	BE112M4	BX112M4	ME4SA4	MX4SA4	18500	21100	36100	42700	9790	289		
14.6	2470	2.2	98.3	—	3/A06L2	BE112M4	BX112M4	ME4SA4	MX4SA4	21700	24800	50200	58000	14100	313		
15.9	2280	1.0	90.7	—	3/A04L2	BE112M4	BX112M4	ME4SA4	MX4SA4	17800	20300	34800	41300	9420	289		
16.3	2230	2.8	88.5	—	3/A06L2	BE112M4	BX112M4	ME4SA4	MX4SA4	21000	23900	48700	56200	13600	313		
16.8	2150	1.6	85.6	—	3/A05L2	BE112M4	BX112M4	ME4SA4	MX4SA4	17400	19900	34200	40600	9240	301		
17.6	2050	1.2	81.7	—	3/A04L2	BE112M4	BX112M4	ME4SA4	MX4SA4	17200	19600	33800	40000	9100	289		
19.0	1910	1.6	75.8	—	3/A05L2	BE112M4	BX112M4	ME4SA4	MX4SA4	16700	19100	33000	39100	8870	301		
19.7	1840	1.0	73.2	—	3/A03L2	BE112M4	BX112M4	ME4SA4	MX4SA4	16500	18900	32700	38700	8770	277		
19.9	1820	1.8	72.5	—	3/A05L2	BE112M4	BX112M4	ME4SA4	MX4SA4	16500	18800	32600	38600	8740	301		
21.1	1720	1.5	68.4	—	3/A04L2	BE112M4	BX112M4	ME4SA4	MX4SA4	16200	18500	32000	37900	8580	289		
22.9	1580	1.0	62.9	—	3/A03L2	BE112M4	BX112M4	ME4SA4	MX4SA4	15700	18000	31200	37000	8340	277		
23.0	1570	2.0	62.6	—	3/A05L2	BE112M4	BX112M4	ME4SA4	MX4SA4	15700	17900	31200	36900	8330	301		
23.1	1570	1.8	62.4	—	3/A04L2	BE112M4	BX112M4	ME4SA4	MX4SA4	15700	17900	31100	36900	8320	289		
25.3	1430	2.3	57.0	—	3/A05L2	BE112M4	BX112M4	ME4SA4	MX4SA4	15200	17400	30300	35900	8070	301		
26.4	1370	1.7	54.5	—	3/A04L2	BE112M4	BX112M4	ME4SA4	MX4SA4	15000	17100	29900	35400	7950	289		
27.0	1340	2.3	53.3	—	3/A05L2	BE112M4	BX112M4	ME4SA4	MX4SA4	14900	17000	29700	35200	7890	301		
27.4	1320	1.3	52.5	—	3/A03L2	BE112M4	BX112M4	ME4SA4	MX4SA4	14800	16900	29600	35000	7850	277		
27.4	1320	1.3	52.5	—	3/A03L2	BE112M4	BX112M4	ME4SA4	MX4SA4	14800	16900	29600	35000	7850	277		
29	1250	1.8	49.7	—	3/A04L2	BE112M4	BX112M4	ME4SA4	MX4SA4	14500	16600	29100	34500	7710	289		
33	1090	1.6	43.4	—	3/A03L2	BE112M4	BX112M4	ME4SA4	MX4SA4	13900	15900	27900	33100	7370	277		
33	1110	2.6	44.3	—	3/A04L2	BE112M4	BX112M4	ME4SA4	MX4SA4	14000	16000	28100	33300	7420	289		
33	1110	3.0	44.0	—	3/A05L2	BE112M4	BX112M4	ME4SA4	MX4SA4	14000	15900	28000	33200	7400	301		
36	1020	1.6	40.5	—	3/A03L2	BE112M4	BX112M4	ME4SA4	MX4SA4	13600	15500	27300	32400	7200	277		
37	980	2.3	39.1	—	3/A04L2	BE112M4	BX112M4	ME4SA4	MX4SA4	13400	15300	27100	32100	7120	289		
41	890	2.6	35.3	—	3/A04L2	BE112M4	BX112M4	ME4SA4	MX4SA4	13000	14800	26200	31100	6880	289		
43	840	2.1	33.5	—	3/A03L2	BE112M4	BX112M4	ME4SA4	MX4SA4	12700	14600	25800	30600	6760	277		
46	780	1.5	31.2	—	3/A01L2	BE112M4	BX112M4	ME4SA4	MX4SA4	3850	3850	13400	14700	2200	267		
48	760	3.0	30.2	—	3/A04L2	BE112M4	BX112M4	ME4SA4	MX4SA4	12300	14100	25000	29700	6530	289		
50	720	2.1	28.8	—	3/A03L2	BE112M4	BX112M4	ME4SA4	MX4SA4	12100	13800	24700	29300	6430	277		
56	640	3.0	25.6	—	3/A04L2	BE112M4	BX112M4	ME4SA4	MX4SA4	11600	13300	23800	28200	6180	289		
62	590	1.0	23.4	—	3/A00L2	BE112M4	BX112M4	ME4SA4	MX4SA4	3500	3500	12300	14300	2000	257		
63	580	1.5	23.0	—	3/A01L2	BE112M4	BX112M4	ME4SA4	MX4SA4	3480	3480	12300	13400	1990	267		
63	580	2.1	23.0	—	3/A03L2	BE112M4	BX112M4	ME4SA4	MX4SA4	11200	12800	23100	27300	5960	277		
74	490	2.2	19.4	—	3/A03L2	BE112M4	BX112M4	ME4SA4	MX4SA4	10600	12100	21900	26000	5640	277		
75	480	1.0	19.1	—	3/A00L2	BE112M4	BX112M4	ME4SA4	MX4SA4	3270	3270	11600	13500	1870	257		
77	475	1.5	18.8	—	3/A01L2	BE112M4	BX112M4	ME4SA4	MX4SA4	3250	3250	11500	12600	1860	267		

$P_1 = 5.5 \text{ kW}$

n_2 min ⁻¹	M_2 Nm	S	i	IE2		IE3		IE2		IE3		Rn_2 [N]					
				MC/PC	MZ/PZ	HC	HZ	FZ									
0.29	130100	0.9	4950	3/V16ML4	—	BE132S4	BX132SB4	—	—	—	—	301500	338200	150000	408		
0.29	135500	0.9	4970	3/V17ML4	—	BE132S4	BX132SB4	—	—	—	—	442000	470000	150000	418		
0.29	139100	1.9	5099	3/V18ML4	—	BE132S4	BX132SB4	—	—	—	—	448200	506000	200000	428		
0.33	111100	1.8	4449	3/V17ML4	—	BE132S4	BX132SB4	—	—	—	—	442000	470000	150000	418		
0.33	119600	2.5	4386	3/V18ML4	—	BE132S4	BX132SB4	—	—	—	—	438600	495300	200000	428		
0.33	124500	2.7	4457	3/V19L4	—	BE132S4	BX132SB4	—	—	—	—	534200	588100	200000	438		
0.35	109600	0.9	4171	3/V15ML4	—	BE132S4	BX132SB4	—	—	—	—	192300	230600	90000	396		
0.35	109600	1.2	4171	3/V16ML4	—	BE132S4	BX132SB4	—	—	—	—	294200	330000	150000	408		
0.35	112600	1.6	4129	3/V17ML4	—	BE132S4	BX132SB4	—	—	—	—	442000	470000	150000	418		
0.40	100800	3.0	3696	3/V18ML4	—	BE132S4	BX132SB4	—	—	—	—	428000	483300	200000	428		
0.42	96300	1.0	3489	3/V15ML4	—	BE132S4	BX132SB4	—	—	—	—	187400	224800	90000	396		
0.42	92400	1.5	3514	3/V16ML4	—	BE132S4	BX132SB4	—	—	—	—	287100	322100	150000	408		
0.44	91100	1.1	3300	3/V15ML4	—	BE132S4	BX132SB4	—	—	—	—	185900	223000	90000	396		
0.46	86400	2.2	3168	3/V17ML4	—	BE132S4	BX132SB4	—	—	—	—	440100	467600	150000	418		
0.51	75700	1.6	2880	3/V16ML4	—	BE132S4	BX132SB4	—	—	—	—	279000	313000	150000	408		
0.52	73100	1.1	2782	3/V14ML4	—	BE132S4	BX132SB4	—	—	—	—	181400	217600	90000	384		
0.53	76700	1.3	2780	3/V15ML4	—	BE132S4	BX132SB4	—	—	—	—	181400	217600	90000	396		
0.53	71100	2.3	2773	3/V17ML4	—	BE132S4	BX132SB4	—	—	—	—	431800	458800	150000	418		
0.55	70400	1.6	2678	3/V16ML4	—	BE132S4	BX132SB4	—	—	—	—	276200	309800	150000	408		
0.58	63300	1.3	2504	3/V14ML4	—	BE132S4	BX132SB4	—	—	—	—	178700	214300	90000	384		

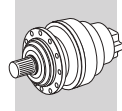

$P_1 = 5.5 \text{ kW}$

n_2 min ⁻¹	M_2 Nm	S	i	Motor Type		IE2		IE3		R _{n2} [N]					Icon
				BE132S4	BX132SB4	IE2	IE3	MC/PC	MZ/PZ	HC	HZ	FZ			
0.62	64700	2.1	2343	3/V16ML4	—	BE132S4	BX132SB4	—	—	—	—	270900	303900	150000	408
0.63	58100	1.1	2318	3/V14ML3	—	BE132S4	BX132SB4	—	—	—	—	176800	212000	90000	384
0.63	57300	1.4	2318	3/V15ML3	—	BE132S4	BX132SB4	—	—	—	—	176800	212000	90000	396
0.72	50600	1.1	2019	3/V13ML3	—	BE132S4	BX132SB4	—	—	—	—	186500	218500	80000	372
0.73	50000	1.4	1994	3/V14ML3	—	BE132S4	BX132SB4	—	—	—	—	173000	207500	90000	384
0.73	49300	1.9	1994	3/V15ML3	—	BE132S4	BX132SB4	—	—	—	—	173000	207500	90000	396
0.76	53000	2.1	1920	3/V16ML4	—	BE132S4	BX132SB4	—	—	—	—	263300	295400	150000	408
0.82	49300	2.1	1785	3/V16ML4	—	BE132S4	BX132SB4	—	—	—	—	260600	292400	150000	408
0.87	43300	1.3	1682	3/V13ML3	—	BE132S4	BX132SB4	—	—	—	—	181700	212900	80000	372
0.88	42800	1.7	1662	3/V14ML3	—	BE132S4	BX132SB4	—	—	—	—	168600	202200	90000	384
0.88	42800	2.1	1662	3/V15ML3	—	BE132S4	BX132SB4	—	—	—	—	168600	202200	90000	396
0.89	42100	1.0	1636	3/V11ML3	—	BE132S4	BX132SB4	—	—	—	—	124900	127400	65000	360
0.90	42800	0.9	1620	3/V13ML3	—	BE132S4	BX132SB4	—	—	—	—	180700	211700	80000	372
0.92	39800	1.4	1589	3/V14ML3	—	BE132S4	BX132SB4	—	—	—	—	167500	200900	90000	384
0.92	40900	2.7	1589	3/V16ML3	—	BE132S4	BX132SB4	—	—	—	—	256300	287500	150000	408
1.0	36500	1.6	1418	3/V13ML3	—	BE132S4	BX132SB4	—	—	—	—	177300	207700	78500	372
1.0	36000	2.4	1400	3/V15ML3	—	BE132S4	BX132SB4	—	—	—	—	164500	197300	88000	396
1.1	32800	1.0	1274	3/V11ML3	—	BE132S4	BX132SB4	—	—	—	—	120500	123000	61600	360
1.1	35500	1.3	1378	3/V11ML3	—	BE132S4	BX132SB4	—	—	—	—	121800	124300	63200	360
1.1	33200	1.5	1291	3/V13ML3	—	BE132S4	BX132SB4	—	—	—	—	174900	205000	76100	372
1.1	34100	1.8	1324	3/V14ML3	—	BE132S4	BX132SB4	—	—	—	—	163200	195700	86300	384
1.1	33600	1.4	1339	3/V14ML3	—	BE132S4	BX132SB4	—	—	—	—	163400	196000	86700	384
1.1	35100	2.6	1329	3/V15ML3	—	BE132S4	BX132SB4	—	—	—	—	163300	195800	86400	396
1.3	29200	1.0	1120	3/V10ML3	—	BE132S4	BX132SB4	—	—	—	—	94200	119400	59000	348
1.3	29100	1.6	1103	3/V11ML3	—	BE132S4	BX132SB4	—	—	—	—	118000	120400	58700	360
1.3	28000	1.8	1088	3/V13ML3	—	BE132S4	BX132SB4	—	—	—	—	170700	200000	71900	372
1.3	28700	1.8	1116	3/V14ML3	—	BE132S4	BX132SB4	—	—	—	—	159200	191000	81500	384
1.4	28400	1.9	1009	3/V13ML3	—	BE132S4	BX132SB4	—	—	—	—	168900	197900	70100	372
1.5	26200	1.2	1004	3/V10ML3	—	BE132S4	BX132SB4	—	—	—	—	92700	117500	56900	348
1.5	25200	1.4	1004	3/V11ML3	—	BE132S4	BX132SB4	—	—	—	—	116500	118800	56900	360
1.5	28000	2.2	997	3/V14ML3	—	BE132S4	BX132SB4	—	—	—	—	156700	187900	78500	384
1.6	23200	1.8	900	3/V11ML3	—	BE132S4	BX132SB4	—	—	—	—	114700	117000	54800	360
1.6	23600	2.3	893	3/V14ML3	—	BE132S4	BX132SB4	—	—	—	—	154200	185000	75700	384
1.7	23000	2.3	870	3/V13ML3	—	BE132S4	BX132SB4	—	—	—	—	165300	193700	66700	372
1.8	20900	1.0	800	3/V09L3	—	BE132S4	BX132SB4	—	—	—	—	79400	102200	29200	336
1.8	23300	1.9	827	3/V11ML3	—	BE132S4	BX132SB4	—	—	—	—	113300	115600	53300	360
1.8	22300	2.2	794	3/V14ML3	—	BE132S4	BX132SB4	—	—	—	—	151700	181900	72800	384
1.9	22000	1.0	773	3/V10ML3	—	BE132S4	BX132SB4	—	—	—	—	89300	113200	52100	348
2.0	19000	2.2	720	3/V11ML3	—	BE132S4	BX132SB4	—	—	—	—	111100	113300	50900	360
2.0	19600	2.3	741	3/V13ML3	—	BE132S4	BX132SB4	—	—	—	—	161600	189300	63200	372
2.1	20700	1.0	701	3/V10ML3	—	BE132S4	BX132SB4	—	—	—	—	88100	111600	50400	348
2.1	18400	2.3	695	3/V14ML3	—	BE132S4	BX132SB4	—	—	—	—	148800	178500	69700	384
2.2	17700	1.0	655	3/V09L3	—	BE132S4	BX132SB4	—	—	—	—	77100	99300	27300	336
2.3	18100	2.2	644	3/V11ML3	—	BE132S4	BX132SB4	—	—	—	—	109300	111500	49000	360
2.4	17500	1.1	614	3/V10ML3	—	BE132S4	BX132SB4	—	—	—	—	86400	109500	48300	348
2.6	15900	1.6	560	3/V10ML3	—	BE132S4	BX132SB4	—	—	—	—	85300	108100	46800	348
2.9	14400	0.9	507	3/V07L3	—	BE132S4	BX132SB4	—	—	32300	40400	72800	95700	31400	324
2.9	14400	1.0	507	3/V09L3	—	BE132S4	BX132SB4	—	—	—	—	74400	95700	25100	336
2.9	14400	1.7	507	3/V10ML3	—	BE132S4	BX132SB4	—	—	—	—	84100	106600	45300	348
3.2	13100	0.9	460	3/V07L3	—	BE132S4	BX132SB4	—	—	31900	39900	71800	94400	30400	324
3.3	12000	1.5	442	3/V09L3	—	BE132S4	BX132SB4	—	—	—	—	72900	93800	24000	336
3.3	12400	2.2	436	3/V10ML3	—	BE132S4	BX132SB4	—	—	—	—	82300	104300	43100	348
3.9	10000	1.3	370	3/V09L3	—	BE132S4	BX132SB4	—	—	—	—	71100	91500	22600	336
4.3	11200	1.0	341	—	3/A07L2	BE132S4	BX132SB4	ME4SB4	MX4SB4	30600	38200	68800	90400	27500	325
5.2	9260	0.9	282	—	3/A07L2	BE132S4	BX132SB4	ME4SB4	MX4SB4	30000	37500	67500	88800	25800	325
6.1	7910	1.1	241	—	3/A07L2	BE132S4	BX132SB4	ME4SB4	MX4SB4	30000	37500	67500	88800	24500	325
6.5	7320	1.2	223	—	3/A07L2	BE132S4	BX132SB4	ME4SB4	MX4SB4	30000	37500	67500	88800	23800	325
7.4	6500	1.3	198	—	3/A07L2	BE132S4	BX132SB4	ME4SB4	MX4SB4	30000	37500	67500	88800	22900	325
7.7	6240	1.2	190	—	3/A06L2	BE132S4	BX132SB4	ME4SB4	MX4SB4	25000	28500	57000	65800	17600	313
8.1	5910	1.8	180	—	3/A07L2	BE132S4	BX132SB4	ME4SB4	MX4SB4	30000	37500	67500	88800	22200	325
8.9	5380	1.2	164	—	3/A06L2	BE132S4	BX132SB4	ME4SB4	MX4SB4	25000	28500	57000	65800	16700	313
9.4	5090	1.8	155	—	3/A07L2	BE132S4	BX132SB4	ME4SB4	MX4SB4	30000	37500	67500	88800	21100	325
10.4	4630	1.7	141	—	3/A06L2	BE132S4	BX132SB4	ME4SB4	MX4SB4	24500	27900	55900	64600	15900	313
10.4	4600	2.4	140	—	3/A07L2	BE132S4	BX132SB4	ME4SB4	MX4SB4	29300	36700	66200	87000	20400	325
11.2	4270	2.6	130	—	3/A07L2	BE132S4	BX132SB4	ME4SB4	MX4SB4	28600	35700	64600	85000	19900	325

A

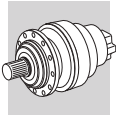

$P_1 = 5.5 \text{ kW}$

n_2 min ⁻¹	M_2 Nm	S	i	IE2		IE3		IE2		IE3		Rn ₂ [N]					
				MC/PC	MZ/PZ	HC	HZ	FZ									
11.7	4190	1.3	125	—	3/A06L2	BE132S4	BX132SB4	ME4SB4	MX4SB4	23500	26800	53900	62200	15300	313		
13.0	3680	1.7	112	—	3/A06L2	BE132S4	BX132SB4	ME4SB4	MX4SB4	22700	25900	52200	60300	14700	313		
13.4	3580	2.5	109	—	3/A07L2	BE132S4	BX132SB4	ME4SB4	MX4SB4	26900	33700	61300	80600	18800	325		
14.9	3300	1.6	98.3	—	3/A06L2	BE132S4	BX132SB4	ME4SB4	MX4SB4	21700	24800	50200	58000	14100	313		
16.5	2970	2.1	88.5	—	3/A06L2	BE132S4	BX132SB4	ME4SB4	MX4SB4	21000	23900	48700	56200	13600	313		
17.1	2870	1.2	85.6	—	3/A05L2	BE132S4	BX132SB4	ME4SB4	MX4SB4	17400	19900	34200	40600	9240	301		
18.0	2720	2.4	81.2	—	3/A06L2	BE132S4	BX132SB4	ME4SB4	MX4SB4	20400	23200	47400	54700	13200	313		
19.3	2540	1.2	75.8	—	3/A05L2	BE132S4	BX132SB4	ME4SB4	MX4SB4	16700	19100	33000	39100	8870	301		
20.1	2430	1.4	72.5	—	3/A05L2	BE132S4	BX132SB4	ME4SB4	MX4SB4	16500	18800	32600	38600	8740	301		
20.9	2340	2.4	69.9	—	3/A06L2	BE132S4	BX132SB4	ME4SB4	MX4SB4	19400	22100	45300	52300	12600	313		
21.3	2290	1.1	68.4	—	3/A04L2	BE132S4	BX132SB4	ME4SB4	MX4SB4	16200	18500	32000	37900	8580	289		
23.3	2100	1.5	62.6	—	3/A05L2	BE132S4	BX132SB4	ME4SB4	MX4SB4	15700	17900	31200	36900	8330	301		
23.4	2090	1.4	62.4	—	3/A04L2	BE132S4	BX132SB4	ME4SB4	MX4SB4	15700	17900	31100	36900	8320	289		
24.3	2010	3.0	60.1	—	3/A06L2	BE132S4	BX132SB4	ME4SB4	MX4SB4	18400	21000	43300	50000	12000	313		
25.6	1910	1.7	57.0	—	3/A05L2	BE132S4	BX132SB4	ME4SB4	MX4SB4	15200	17400	30300	35900	8070	301		
26.2	1870	2.4	55.7	—	3/A06L2	BE132S4	BX132SB4	ME4SB4	MX4SB4	18000	20500	42300	48900	11700	313		
26.8	1830	1.3	54.5	—	3/A04L2	BE132S4	BX132SB4	ME4SB4	MX4SB4	15000	17100	29900	35400	7950	289		
27.4	1790	1.7	53.3	—	3/A05L2	BE132S4	BX132SB4	ME4SB4	MX4SB4	14900	17000	29700	35200	7890	301		
28.2	1730	3.0	51.7	—	3/A06L2	BE132S4	BX132SB4	ME4SB4	MX4SB4	17500	20000	41400	47800	11400	313		
29.4	1670	1.4	49.7	—	3/A04L2	BE132S4	BX132SB4	ME4SB4	MX4SB4	14500	16600	29100	34500	7710	289		
31	1580	2.4	47.2	—	3/A06L2	BE132S4	BX132SB4	ME4SB4	MX4SB4	17000	19400	40300	46500	11000	313		
33	1490	1.9	44.3	—	3/A04L2	BE132S4	BX132SB4	ME4SB4	MX4SB4	14000	16000	28100	33300	7420	289		
33	1480	2.2	44.0	—	3/A05L2	BE132S4	BX132SB4	ME4SB4	MX4SB4	14000	15900	28000	33200	7400	301		
37	1310	1.7	39.1	—	3/A04L2	BE132S4	BX132SB4	ME4SB4	MX4SB4	13400	15300	27100	32100	7120	289		
37	1310	2.3	39.0	—	3/A05L2	BE132S4	BX132SB4	ME4SB4	MX4SB4	13400	15300	27000	32000	7110	301		
41	1180	1.9	35.3	—	3/A04L2	BE132S4	BX132SB4	ME4SB4	MX4SB4	13000	14800	26200	31100	6880	289		
42	1170	3.0	34.9	—	3/A06L2	BE132S4	BX132SB4	ME4SB4	MX4SB4	15400	17500	36800	42500	9990	313		
48	1010	2.2	30.2	—	3/A04L2	BE132S4	BX132SB4	ME4SB4	MX4SB4	12300	14100	25000	29700	6530	289		
57	860	2.2	25.6	—	3/A04L2	BE132S4	BX132SB4	ME4SB4	MX4SB4	11600	13300	23800	28200	6180	289		

$P_1 = 7.5 \text{ kW}$

n_2 min ⁻¹	M_2 Nm	S	i	IE2		IE3		IE2		IE3		Rn ₂ [N]					
				MC/PC	MZ/PZ	HC	HZ	FZ									
0.28	180100	2.3	5164	3/V19L4	—	BE132MA4	BX132MA4	—	—	—	—	545500	600600	200000	438		
0.29	189300	1.4	5099	3/V18ML4	—	BE132MA4	BX132MA4	—	—	—	—	448200	506000	200000	428		
0.33	151200	1.3	4449	3/V17ML4	—	BE132MA4	BX132MA4	—	—	—	—	442000	470000	150000	418		
0.33	162800	1.8	4386	3/V18ML4	—	BE132MA4	BX132MA4	—	—	—	—	438600	495300	200000	428		
0.33	169400	2.0	4457	3/V19L4	—	BE132MA4	BX132MA4	—	—	—	—	534200	588100	200000	438		
0.35	149200	0.9	4171	3/V16ML4	—	BE132MA4	BX132MA4	—	—	—	—	294200	330000	150000	408		
0.35	153300	1.2	4129	3/V17ML4	—	BE132MA4	BX132MA4	—	—	—	—	442000	470000	150000	418		
0.36	152000	2.5	4095	3/V19L4	—	BE132MA4	BX132MA4	—	—	—	—	527700	581100	200000	438		
0.40	137200	2.2	3696	3/V18ML4	—	BE132MA4	BX132MA4	—	—	—	—	428000	483300	200000	428		
0.42	125700	1.1	3514	3/V16ML4	—	BE132MA4	BX132MA4	—	—	—	—	287100	322100	150000	408		
0.42	129700	2.3	3495	3/V18ML4	—	BE132MA4	BX132MA4	—	—	—	—	424600	479400	200000	428		
0.45	122800	2.9	3231	3/V19L4	—	BE132MA4	BX132MA4	—	—	—	—	510200	561700	200000	438		
0.46	117600	1.6	3168	3/V17ML4	—	BE132MA4	BX132MA4	—	—	—	—	440100	467600	150000	418		
0.50	109300	2.5	2945	3/V18ML4	—	BE132MA4	BX132MA4	—	—	—	—	414400	467900	200000	428		
0.51	103000	1.2	2880	3/V16ML4	—	BE132MA4	BX132MA4	—	—	—	—	279000	313000	150000	408		
0.53	104400	1.0	2780	3/V15ML4	—	BE132MA4	BX132MA4	—	—	—	—	181400	217600	90000	396		
0.53	96700	1.7	2773	3/V17ML4	—	BE132MA4	BX132MA4	—	—	—	—	431800	458800	150000	418		
0.55	95800	1.2	2678	3/V16ML4	—	BE132MA4	BX132MA4	—	—	—	—	276200	309800	150000	408		
0.58	86200	0.9	2504	3/V14ML4	—	BE132MA4	BX132MA4	—	—	—	—	178700	214300	90000	384		
0.62	88000	1.5	2343	3/V16ML4	—	BE132MA4	BX132MA4	—	—	—	—	270900	303900	150000	408		
0.63	78000	1.0	2318	3/V15ML3	—	BE132MA4	BX132MA4	—	—	—	—	176800	212000	90000	396		
0.64	85200	2.5	2295	3/V18ML4	—	BE132MA4	BX132MA4	—	—	—	—	399900	451500	200000	428		
0.73	68000	1.0	1994	3/V14ML3	—	BE132MA4	BX132MA4	—	—	—	—	173000	207500	90000	384		
0.73	67100	1.4	1994	3/V15ML3	—	BE132MA4	BX132MA4	—	—	—	—	173000	207500	90000	396		
0.76	72100	1.6	1920	3/V16ML4	—	BE132MA4	BX132MA4	—	—	—	—	263300	295400	150000	408		
0.82	67100	1.6	1785	3/V16ML4	—	BE132MA4	BX132MA4	—	—	—	—	260600	292400	150000	408		
0.87	58900	1.0	1682	3/V13ML3	—	BE132MA4	BX132MA4	—	—	—	—	181700	212900	80000	372		
0.88	58200	1.3	1662	3/V14ML3	—	BE132MA4	BX132MA4	—	—	—	—	168600	202200	90000	384		

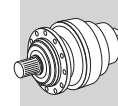

$P_1 = 7.5 \text{ kW}$

n ₂ min ⁻¹	M ₂ Nm	S	i	IE2		IE3		Rn ₂ [N]					Icon		
				IE2	IE3	IE2	IE3	MC/PC	MZ/PZ	HC	HZ	FZ			
0.88	58200	1.6	1662	3/V15ML3	—	BE132MA4	BX132MA4	—	—	—	—	168600	202200	90000	396
0.92	54200	1.0	1589	3/V14ML3	—	BE132MA4	BX132MA4	—	—	—	—	167500	200900	90000	384
0.92	55700	2.0	1589	3/V16ML3	—	BE132MA4	BX132MA4	—	—	—	—	256300	287500	150000	408
1.0	49700	1.1	1418	3/V13ML3	—	BE132MA4	BX132MA4	—	—	—	—	177300	207700	78500	372
1.0	49100	1.8	1400	3/V15ML3	—	BE132MA4	BX132MA4	—	—	—	—	164500	197300	88000	396
1.1	48300	1.0	1378	3/V11ML3	—	BE132MA4	BX132MA4	—	—	—	—	121800	124300	63200	360
1.1	45200	1.1	1291	3/V13ML3	—	BE132MA4	BX132MA4	—	—	—	—	174900	205000	76100	372
1.1	46400	1.3	1324	3/V14ML3	—	BE132MA4	BX132MA4	—	—	—	—	163200	195700	86300	384
1.1	45700	1.0	1339	3/V14ML3	—	BE132MA4	BX132MA4	—	—	—	—	163400	196000	86700	384
1.1	47800	1.9	1329	3/V15ML3	—	BE132MA4	BX132MA4	—	—	—	—	163300	195800	86400	396
1.1	46400	2.4	1324	3/V16ML3	—	BE132MA4	BX132MA4	—	—	—	—	249700	280100	143900	408
1.3	39700	1.1	1103	3/V11ML3	—	BE132MA4	BX132MA4	—	—	—	—	118000	120400	58700	360
1.3	38100	1.3	1088	3/V13ML3	—	BE132MA4	BX132MA4	—	—	—	—	170700	200000	71900	372
1.3	39100	1.3	1116	3/V14ML3	—	BE132MA4	BX132MA4	—	—	—	—	159200	191000	81500	384
1.3	40300	2.2	1120	3/V15ML3	—	BE132MA4	BX132MA4	—	—	—	—	159300	191100	81600	396
1.4	38600	1.4	1009	3/V13ML3	—	BE132MA4	BX132MA4	—	—	—	—	168900	197900	70100	372
1.5	34300	1.0	1004	3/V11ML3	—	BE132MA4	BX132MA4	—	—	—	—	116500	118800	56900	360
1.5	38200	1.6	997	3/V14ML3	—	BE132MA4	BX132MA4	—	—	—	—	156700	187900	78500	384
1.5	38200	2.3	997	3/V15ML3	—	BE132MA4	BX132MA4	—	—	—	—	156700	187900	78500	396
1.6	31500	1.3	900	3/V11ML3	—	BE132MA4	BX132MA4	—	—	—	—	114700	117000	54800	360
1.6	32100	1.7	893	3/V14ML3	—	BE132MA4	BX132MA4	—	—	—	—	154200	185000	75700	384
1.7	31300	1.7	870	3/V13ML3	—	BE132MA4	BX132MA4	—	—	—	—	165300	193700	66700	372
1.7	32100	2.5	840	3/V15ML3	—	BE132MA4	BX132MA4	—	—	—	—	152900	183400	74200	396
1.8	31600	1.4	827	3/V11ML3	—	BE132MA4	BX132MA4	—	—	—	—	113300	115600	53300	360
1.8	30400	1.6	794	3/V14ML3	—	BE132MA4	BX132MA4	—	—	—	—	151700	181900	72800	384
2.0	25900	1.6	720	3/V11ML3	—	BE132MA4	BX132MA4	—	—	—	—	111100	113300	50900	360
2.0	26600	1.7	741	3/V13ML3	—	BE132MA4	BX132MA4	—	—	—	—	161600	189300	63200	372
2.1	25000	1.7	695	3/V14ML3	—	BE132MA4	BX132MA4	—	—	—	—	148800	178500	69700	384
2.3	24600	1.6	644	3/V11ML3	—	BE132MA4	BX132MA4	—	—	—	—	109300	111500	49000	360
2.6	21700	1.2	560	3/V10ML3	—	BE132MA4	BX132MA4	—	—	—	—	85300	108100	46800	348
2.9	19600	1.3	507	3/V10ML3	—	BE132MA4	BX132MA4	—	—	—	—	84100	106600	45300	348
3.3	16300	1.1	442	3/V09L3	—	BE132MA4	BX132MA4	—	—	—	—	72900	93800	24000	336
3.3	16900	1.6	436	3/V10ML3	—	BE132MA4	BX132MA4	—	—	—	—	82300	104300	43100	348
3.9	13600	1.0	370	3/V09L3	—	BE132MA4	BX132MA4	—	—	—	—	71100	91500	22600	336
6.5	9960	0.9	223	—	3/A07L2	BE132MA4	BX132MA4	ME4LA4	MX4LA4	30000	37500	67500	88800	23800	325
7.4	8850	1.0	198	—	3/A07L2	BE132MA4	BX132MA4	ME4LA4	MX4LA4	30000	37500	67500	88800	22900	325
7.7	8490	0.9	190	—	3/A06L2	BE132MA4	BX132MA4	ME4LA4	MX4LA4	25000	28500	57000	65800	17600	313
8.1	8040	1.4	180	—	3/A07L2	BE132MA4	BX132MA4	ME4LA4	MX4LA4	30000	37500	67500	88800	22200	325
9.4	6930	1.3	155	—	3/A07L2	BE132MA4	BX132MA4	ME4LA4	MX4LA4	30000	37500	67500	88800	21100	325
10.4	6300	1.2	141	—	3/A06L2	BE132MA4	BX132MA4	ME4LA4	MX4LA4	24500	27900	55900	64600	15900	313
10.4	6250	1.8	140	—	3/A07L2	BE132MA4	BX132MA4	ME4LA4	MX4LA4	29300	36700	66200	87000	20400	325
11.2	5810	1.9	130	—	3/A07L2	BE132MA4	BX132MA4	ME4LA4	MX4LA4	28600	35700	64600	85000	19900	325
11.7	5700	1.0	125	—	3/A06L2	BE132MA4	BX132MA4	ME4LA4	MX4LA4	23500	26800	53900	62200	15300	313
13.0	5000	1.2	112	—	3/A06L2	BE132MA4	BX132MA4	ME4LA4	MX4LA4	22700	25900	52200	60300	14700	313
13.4	4870	1.8	109	—	3/A07L2	BE132MA4	BX132MA4	ME4LA4	MX4LA4	26900	33700	61300	80600	18800	325
14.9	4490	1.2	98.3	—	3/A06L2	BE132MA4	BX132MA4	ME4LA4	MX4LA4	21700	24800	50200	58000	14100	313
16.5	4040	1.5	88.5	—	3/A06L2	BE132MA4	BX132MA4	ME4LA4	MX4LA4	21000	23900	48700	56200	13600	313
16.6	4000	2.5	87.7	—	3/A07L2	BE132MA4	BX132MA4	ME4LA4	MX4LA4	25100	31400	57500	75600	17500	325
17.1	3910	0.9	85.6	—	3/A05L2	BE132MA4	BX132MA4	ME4LA4	MX4LA4	17400	19900	34200	40600	9240	301
18.0	3710	1.7	81.2	—	3/A06L2	BE132MA4	BX132MA4	ME4LA4	MX4LA4	20400	23200	47400	54700	13200	313
20.1	3310	1.0	72.5	—	3/A05L2	BE132MA4	BX132MA4	ME4LA4	MX4LA4	16500	18800	32600	38600	8740	301
20.9	3190	1.8	69.9	—	3/A06L2	BE132MA4	BX132MA4	ME4LA4	MX4LA4	19400	22100	45300	52300	12600	313
21.4	3120	2.5	68.3	—	3/A07L2	BE132MA4	BX132MA4	ME4LA4	MX4LA4	23100	28900	53300	70100	16100	325
23.3	2860	1.1	62.6	—	3/A05L2	BE132MA4	BX132MA4	ME4LA4	MX4LA4	15700	17900	31200	36900	8330	301
23.4	2850	1.0	62.4	—	3/A04L2	BE132MA4	BX132MA4	ME4LA4	MX4LA4	15700	17900	31100	36900	8320	289
24.3	2740	2.2	60.1	—	3/A06L2	BE132MA4	BX132MA4	ME4LA4	MX4LA4	18400	21000	43300	50000	12000	313
25.5	2610	2.5	57.3	—	3/A07L2	BE132MA4	BX132MA4	ME4LA4	MX4LA4	21800	27200	50600	66500	15200	325
25.6	2600	1.3	57.0	—	3/A05L2	BE132MA4	BX132MA4	ME4LA4	MX4LA4	15200	17400	30300	35900	8070	301
26.2	2540	1.8	55.7	—	3/A06L2	BE132MA4	BX132MA4	ME4LA4	MX4LA4	18000	20500	42300	48900	11700	313
26.8	2490	1.0	54.5	—	3/A04L2	BE132MA4	BX132MA4	ME4LA4	MX4LA4	15000	17100	29900	35400	7950	289
27.4	2430	1.2	53.3	—	3/A05L2	BE132MA4	BX132MA4	ME4LA4	MX4LA4	14900	17000	29700	35200	7890	301
28.2	2360	2.2	51.7	—	3/A06L2	BE132MA4	BX132MA4	ME4LA4	MX4LA4	17500	20000	41400	47800	11400	313
29.4	2270	1.0	49.7	—	3/A04L2	BE132MA4	BX132MA4	ME4LA4	MX4LA4	14500	16600	29100	34500	7710	289
31	2150	1.8	47.2	—	3/A06L2	BE132MA4	BX132MA4	ME4LA4	MX4LA4	17000	19400	40300	46500	11000	313
33	2020	1.4	44.3	—	3/A04L2	BE132MA4	BX132MA4	ME4LA4	MX4LA4	14000	16000	28100	33300	7420	289



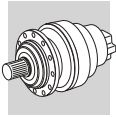

$P_1 = 7.5 \text{ kW}$

n_2 min ⁻¹	M_2 Nm	S	i					R_{n_2} [N]							
						IE2	IE3	IE2	IE3	MC/PC	MZ/PZ	HC		HZ	FZ
33	2010	1.6	44.0	—	3/A05L2	BE132MA4	BX132MA4	ME4LA4	MX4LA4	14000	15900	28000	33200	7400	301
36	1880	2.6	41.1	—	3/A06L2	BE132MA4	BX132MA4	ME4LA4	MX4LA4	16200	18500	38600	44600	10500	313
37	1780	1.3	39.1	—	3/A04L2	BE132MA4	BX132MA4	ME4LA4	MX4LA4	13400	15300	27100	32100	7120	289
37	1780	1.7	39.0	—	3/A05L2	BE132MA4	BX132MA4	ME4LA4	MX4LA4	13400	15300	27000	32000	7110	301
41	1610	1.4	35.3	—	3/A04L2	BE132MA4	BX132MA4	ME4LA4	MX4LA4	13000	14800	26200	31100	6880	289
42	1590	2.2	34.9	—	3/A06L2	BE132MA4	BX132MA4	ME4LA4	MX4LA4	15400	17500	36800	42500	9990	313
45	1470	2.3	32.2	—	3/A05L2	BE132MA4	BX132MA4	ME4LA4	MX4LA4	12600	14400	25500	30300	6670	301
45	1490	2.6	32.7	—	3/A06L2	BE132MA4	BX132MA4	ME4LA4	MX4LA4	15000	17200	36100	41700	9780	313
48	1380	1.6	30.2	—	3/A04L2	BE132MA4	BX132MA4	ME4LA4	MX4LA4	12300	14100	25000	29700	6530	289
53	1260	2.2	27.7	—	3/A04L2	BE132MA4	BX132MA4	ME4LA4	MX4LA4	12000	13700	24400	28900	6350	289
53	1260	2.3	27.7	—	3/A05L2	BE132MA4	BX132MA4	ME4LA4	MX4LA4	12000	13700	24400	28900	6350	301
53	1260	2.6	27.7	—	3/A06L2	BE132MA4	BX132MA4	ME4LA4	MX4LA4	14200	16200	34300	39600	9250	313
57	1170	1.6	25.6	—	3/A04L2	BE132MA4	BX132MA4	ME4LA4	MX4LA4	11600	13300	23800	28200	6180	289
66	1010	2.3	22.1	—	3/A04L2	BE132MA4	BX132MA4	ME4LA4	MX4LA4	11100	12700	22800	27000	5880	289
66	1010	2.3	22.1	—	3/A05L2	BE132MA4	BX132MA4	ME4LA4	MX4LA4	11100	12700	22800	27000	5880	301
78	850	2.3	18.7	—	3/A04L2	BE132MA4	BX132MA4	ME4LA4	MX4LA4	10500	12000	21700	25700	5570	289
78	850	2.3	18.7	—	3/A05L2	BE132MA4	BX132MA4	ME4LA4	MX4LA4	10500	12000	21700	25700	5570	301

$P_1 = 9.2 \text{ kW}$

n_2 min ⁻¹	M_2 Nm	S	i					R_{n_2} [N]						
						IE2	IE3	IE2	IE3	MC/PC	MZ/PZ	HC		HZ
0.28	220600	1.9	5164	3/V19L4	—	BE132MB4	BX160MA4	—	—	—	545500	600600	200000	438
0.29	231800	1.1	5099	3/V18ML4	—	BE132MB4	BX160MA4	—	—	—	448200	506000	200000	428
0.29	218000	2.5	5040	3/V21L4	—	BE132MB4	BX160MA4	—	—	—	769000	915300	1200000	448
0.32	209300	2.6	4550	3/V21L4	—	BE132MB4	BX160MA4	—	—	—	757800	902100	1200000	448
0.33	185200	1.1	4449	3/V17ML4	—	BE132MB4	BX160MA4	—	—	—	442000	470000	150000	418
0.33	199300	1.5	4386	3/V18ML4	—	BE132MB4	BX160MA4	—	—	—	438600	495300	200000	428
0.33	207500	1.6	4457	3/V19L4	—	BE132MB4	BX160MA4	—	—	—	534200	588100	200000	438
0.35	187700	1.0	4129	3/V17ML4	—	BE132MB4	BX160MA4	—	—	—	442000	470000	150000	418
0.36	186100	2.0	4095	3/V19L4	—	BE132MB4	BX160MA4	—	—	—	527700	581100	200000	438
0.39	173900	2.6	3780	3/V21L4	—	BE132MB4	BX160MA4	—	—	—	738000	878500	1200000	448
0.40	168000	1.8	3696	3/V18ML4	—	BE132MB4	BX160MA4	—	—	—	428000	483300	200000	428
0.42	158900	1.9	3495	3/V18ML4	—	BE132MB4	BX160MA4	—	—	—	424600	479400	200000	428
0.45	150400	2.4	3231	3/V19L4	—	BE132MB4	BX160MA4	—	—	—	510200	561700	200000	438
0.46	144000	1.3	3168	3/V17ML4	—	BE132MB4	BX160MA4	—	—	—	440100	467600	150000	418
0.50	133900	2.0	2945	3/V18ML4	—	BE132MB4	BX160MA4	—	—	—	414400	467900	200000	428
0.51	126200	1.0	2880	3/V16ML4	—	BE132MB4	BX160MA4	—	—	—	279000	313000	150000	408
0.53	118400	1.4	2773	3/V17ML4	—	BE132MB4	BX160MA4	—	—	—	431800	458800	150000	418
0.55	117300	1.0	2678	3/V16ML4	—	BE132MB4	BX160MA4	—	—	—	276200	309800	150000	408
0.59	114700	2.6	2464	3/V18ML4	—	BE132MB4	BX160MA4	—	—	—	403900	456100	200000	428
0.62	107800	1.2	2343	3/V16ML4	—	BE132MB4	BX160MA4	—	—	—	270900	303900	150000	408
0.64	104300	2.0	2295	3/V18ML4	—	BE132MB4	BX160MA4	—	—	—	399900	451500	200000	428
0.73	82200	1.1	1994	3/V15ML3	—	BE132MB4	BX160MA4	—	—	—	173000	207500	90000	396
0.76	88300	1.3	1920	3/V16ML4	—	BE132MB4	BX160MA4	—	—	—	263300	295400	150000	408
0.82	82100	1.3	1785	3/V16ML4	—	BE132MB4	BX160MA4	—	—	—	260600	292400	150000	408
0.88	71300	1.0	1662	3/V14ML3	—	BE132MB4	BX160MA4	—	—	—	168600	202200	90000	384
0.88	71300	1.3	1662	3/V15ML3	—	BE132MB4	BX160MA4	—	—	—	168600	202200	90000	396
0.92	68200	1.6	1589	3/V16ML3	—	BE132MB4	BX160MA4	—	—	—	256300	287500	150000	408
1.0	60800	0.9	1418	3/V13ML3	—	BE132MB4	BX160MA4	—	—	—	177300	207700	78500	372
1.0	60100	1.4	1400	3/V15ML3	—	BE132MB4	BX160MA4	—	—	—	164500	197300	88000	396
1.1	55400	0.9	1291	3/V13ML3	—	BE132MB4	BX160MA4	—	—	—	174900	205000	76100	372
1.1	56800	1.1	1324	3/V14ML3	—	BE132MB4	BX160MA4	—	—	—	163200	195700	86300	384
1.1	58500	1.5	1329	3/V15ML3	—	BE132MB4	BX160MA4	—	—	—	163300	195800	86400	396
1.1	56800	2.0	1324	3/V16ML3	—	BE132MB4	BX160MA4	—	—	—	249700	280100	143900	408
1.1	60900	2.5	1365	3/V17ML3	—	BE132MB4	BX160MA4	—	—	—	390300	414600	145400	418
1.2	57600	2.5	1215	3/V17ML3	—	BE132MB4	BX160MA4	—	—	—	383800	407800	139800	418
1.3	48600	0.9	1103	3/V11ML3	—	BE132MB4	BX160MA4	—	—	—	118000	120400	58700	360
1.3	46700	1.1	1088	3/V13ML3	—	BE132MB4	BX160MA4	—	—	—	170700	200000	71900	372
1.3	47900	1.1	1116	3/V14ML3	—	BE132MB4	BX160MA4	—	—	—	159200	191000	81500	384
1.3	49300	1.8	1120	3/V15ML3	—	BE132MB4	BX160MA4	—	—	—	159300	191100	81600	396
1.3	50600	2.5	1134	3/V17ML3	—	BE132MB4	BX160MA4	—	—	—	380100	403800	136600	418

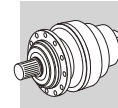

$P_1 = 9.2 \text{ kW}$

n ₂ min ⁻¹	M ₂ Nm	S	i	IE2		IE3		IE2		IE3		Rn ₂ [N]					📄
				MC/PC	MZ/PZ	HC	HZ	FZ									
1.4	47300	1.1	1009	3/V13ML3	—	BE132MB4	BX160MA4	—	—	—	—	168900	197900	70100	372		
1.4	47200	2.5	1059	3/V16ML3	—	BE132MB4	BX160MA4	—	—	—	—	241900	271300	133600	408		
1.4	48600	2.6	1024	3/V17ML3	—	BE132MB4	BX160MA4	—	—	—	—	374500	397900	132100	418		
1.5	46700	1.3	997	3/V14ML3	—	BE132MB4	BX160MA4	—	—	—	—	156700	187900	78500	384		
1.5	46700	1.9	997	3/V15ML3	—	BE132MB4	BX160MA4	—	—	—	—	156700	187900	78500	396		
1.6	38600	1.1	900	3/V11ML3	—	BE132MB4	BX160MA4	—	—	—	—	114700	117000	54800	360		
1.6	39300	1.4	893	3/V14ML3	—	BE132MB4	BX160MA4	—	—	—	—	154200	185000	75700	384		
1.6	39800	2.5	893	3/V16ML3	—	BE132MB4	BX160MA4	—	—	—	—	236000	264800	126200	408		
1.7	38300	1.4	870	3/V13ML3	—	BE132MB4	BX160MA4	—	—	—	—	165300	193700	66700	372		
1.7	39400	2.0	840	3/V15ML3	—	BE132MB4	BX160MA4	—	—	—	—	152900	183400	74200	396		
1.7	40400	2.6	851	3/V17ML3	—	BE132MB4	BX160MA4	—	—	—	—	364700	387500	124200	418		
1.8	38800	1.1	827	3/V11ML3	—	BE132MB4	BX160MA4	—	—	—	—	113300	115600	53300	360		
1.8	37200	1.3	794	3/V14ML3	—	BE132MB4	BX160MA4	—	—	—	—	151700	181900	72800	384		
1.8	37700	2.6	794	3/V16ML3	—	BE132MB4	BX160MA4	—	—	—	—	232200	260400	121400	408		
2.0	31700	1.3	720	3/V11ML3	—	BE132MB4	BX160MA4	—	—	—	—	111100	113300	50900	360		
2.0	32600	1.4	741	3/V13ML3	—	BE132MB4	BX160MA4	—	—	—	—	161600	189300	63200	372		
2.1	30600	1.4	695	3/V14ML3	—	BE132MB4	BX160MA4	—	—	—	—	148800	178500	69700	384		
2.2	31900	2.7	665	3/V15ML3	—	BE132MB4	BX160MA4	—	—	—	—	147900	177300	68600	396		
2.2	31700	2.6	669	3/V16ML3	—	BE132MB4	BX160MA4	—	—	—	—	226500	254100	114600	408		
2.3	30200	1.3	644	3/V11ML3	—	BE132MB4	BX160MA4	—	—	—	—	109300	111500	49000	360		
2.6	26600	1.0	560	3/V10ML3	—	BE132MB4	BX160MA4	—	—	—	—	85300	108100	46800	348		
2.9	24000	1.0	507	3/V10ML3	—	BE132MB4	BX160MA4	—	—	—	—	84100	106600	45300	348		
3.3	20700	1.3	436	3/V10ML3	—	BE132MB4	BX160MA4	—	—	—	—	82300	104300	43100	348		
8.1	9850	1.1	180	—	3/A07L2	BE132MB4	BX160MA4	ME4LB4	MX5SA4	30000	37500	67500	88800	22200	325		
9.4	8480	1.1	155	—	3/A07L2	BE132MB4	BX160MA4	ME4LB4	MX5SA4	30000	37500	67500	88800	21100	325		
10.4	7710	1.0	141	—	3/A06L2	BE132MB4	BX160MA4	ME4LB4	MX5SA4	24500	27900	55900	64600	15900	313		
10.4	7660	1.4	140	—	3/A07L2	BE132MB4	BX160MA4	ME4LB4	MX5SA4	29300	36700	66200	87000	20400	325		
11.2	7110	1.6	130	—	3/A07L2	BE132MB4	BX160MA4	ME4LB4	MX5SA4	28600	35700	64600	85000	19900	325		
13.0	6130	1.0	112	—	3/A06L2	BE132MB4	BX160MA4	ME4LB4	MX5SA4	22700	25900	52200	60300	14700	313		
13.4	5960	1.5	109	—	3/A07L2	BE132MB4	BX160MA4	ME4LB4	MX5SA4	26900	33700	61300	80600	18800	325		
14.9	5490	1.0	98.3	—	3/A06L2	BE132MB4	BX160MA4	ME4LB4	MX5SA4	21700	24800	50200	58000	14100	313		
16.5	4940	1.3	88.5	—	3/A06L2	BE132MB4	BX160MA4	ME4LB4	MX5SA4	21000	23900	48700	56200	13600	313		
16.6	4900	2.1	87.7	—	3/A07L2	BE132MB4	BX160MA4	ME4LB4	MX5SA4	25100	31400	57500	75600	17500	325		
18.0	4540	1.4	81.2	—	3/A06L2	BE132MB4	BX160MA4	ME4LB4	MX5SA4	20400	23200	47400	54700	13200	313		
20.9	3910	1.5	69.9	—	3/A06L2	BE132MB4	BX160MA4	ME4LB4	MX5SA4	19400	22100	45300	52300	12600	313		
21.4	3820	2.1	68.3	—	3/A07L2	BE132MB4	BX160MA4	ME4LB4	MX5SA4	23100	28900	53300	70100	16100	325		
23.3	3500	0.9	62.6	—	3/A05L2	BE132MB4	BX160MA4	ME4LB4	MX5SA4	15700	17900	31200	36900	8330	301		
24.3	3360	1.8	60.1	—	3/A06L2	BE132MB4	BX160MA4	ME4LB4	MX5SA4	18400	21000	43300	50000	12000	313		
25.5	3200	2.1	57.3	—	3/A07L2	BE132MB4	BX160MA4	ME4LB4	MX5SA4	21800	27200	50600	66500	15200	325		
25.6	3180	1.0	57.0	—	3/A05L2	BE132MB4	BX160MA4	ME4LB4	MX5SA4	15200	17400	30300	35900	8070	301		
26.2	3110	1.5	55.7	—	3/A06L2	BE132MB4	BX160MA4	ME4LB4	MX5SA4	18000	20500	42300	48900	11700	313		
27.4	2980	1.0	53.3	—	3/A05L2	BE132MB4	BX160MA4	ME4LB4	MX5SA4	14900	17000	29700	35200	7890	301		
28.2	2890	1.8	51.7	—	3/A06L2	BE132MB4	BX160MA4	ME4LB4	MX5SA4	17500	20000	41400	47800	11400	313		
31	2640	1.5	47.2	—	3/A06L2	BE132MB4	BX160MA4	ME4LB4	MX5SA4	17000	19400	40300	46500	11000	313		
33	2480	1.2	44.3	—	3/A04L2	BE132MB4	BX160MA4	ME4LB4	MX5SA4	14000	16000	28100	33300	7420	289		
33	2460	1.3	44.0	—	3/A05L2	BE132MB4	BX160MA4	ME4LB4	MX5SA4	14000	15900	28000	33200	7400	301		
36	2300	2.1	41.1	—	3/A06L2	BE132MB4	BX160MA4	ME4LB4	MX5SA4	16200	18500	38600	44600	10500	313		
37	2180	1.0	39.1	—	3/A04L2	BE132MB4	BX160MA4	ME4LB4	MX5SA4	13400	15300	27100	32100	7120	289		
37	2180	1.4	39.0	—	3/A05L2	BE132MB4	BX160MA4	ME4LB4	MX5SA4	13400	15300	27000	32000	7110	301		
41	1970	1.2	35.3	—	3/A04L2	BE132MB4	BX160MA4	ME4LB4	MX5SA4	13000	14800	26200	31100	6880	289		
42	1950	1.8	34.9	—	3/A06L2	BE132MB4	BX160MA4	ME4LB4	MX5SA4	15400	17500	36800	42500	9990	313		
45	1800	1.8	32.2	—	3/A05L2	BE132MB4	BX160MA4	ME4LB4	MX5SA4	12600	14400	25500	30300	6670	301		
45	1830	2.1	32.7	—	3/A06L2	BE132MB4	BX160MA4	ME4LB4	MX5SA4	15000	17200	36100	41700	9780	313		
48	1690	1.3	30.2	—	3/A04L2	BE132MB4	BX160MA4	ME4LB4	MX5SA4	12300	14100	25000	29700	6530	289		
53	1550	1.8	27.7	—	3/A04L2	BE132MB4	BX160MA4	ME4LB4	MX5SA4	12000	13700	24400	28900	6350	289		
53	1550	1.8	27.7	—	3/A05L2	BE132MB4	BX160MA4	ME4LB4	MX5SA4	12000	13700	24400	28900	6350	301		
53	1550	2.1	27.7	—	3/A06L2	BE132MB4	BX160MA4	ME4LB4	MX5SA4	14200	16200	34300	39600	9250	313		
57	1430	1.3	25.6	—	3/A04L2	BE132MB4	BX160MA4	ME4LB4	MX5SA4	11600	13300	23800	28200	6180	289		
66	1230	1.8	22.1	—	3/A04L2	BE132MB4	BX160MA4	ME4LB4	MX5SA4	11100	12700	22800	27000	5880	289		
66	1230	1.8	22.1	—	3/A05L2	BE132MB4	BX160MA4	ME4LB4	MX5SA4	11100	12700	22800	27000	5880	301		
78	1040	1.8	18.7	—	3/A04L2	BE132MB4	BX160MA4	ME4LB4	MX5SA4	10500	12000	21700	25700	5570	289		
78	1040	1.8	18.7	—	3/A05L2	BE132MB4	BX160MA4	ME4LB4	MX5SA4	10500	12000	21700	25700	5570	301		

A

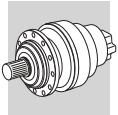

$P_1 = 11 \text{ kW}$

n_2 min ⁻¹	M_2 Nm	S	i	IE2		IE3		Rn ₂ [N]					📄		
				IE2	IE3	IE2	IE3	MC/PC	MZ/PZ	HC	HZ	FZ			
0.28	264700	1.6	5164	3/V19L4	—	BE160M4	BX160MB4	—	—	—	—	545500	600600	200000	438
0.29	278100	1.0	5099	3/V18ML4	—	BE160M4	BX160MB4	—	—	—	—	448200	506000	200000	428
0.29	261600	2.1	5040	3/V21L4	—	BE160M4	BX160MB4	—	—	—	—	769000	915300	1200000	448
0.32	251200	2.2	4550	3/V21L4	—	BE160M4	BX160MB4	—	—	—	—	757800	902100	1200000	448
0.33	239200	1.2	4386	3/V18ML4	—	BE160M4	BX160MB4	—	—	—	—	438600	495300	200000	428
0.33	248900	1.4	4457	3/V19L4	—	BE160M4	BX160MB4	—	—	—	—	534200	588100	200000	438
0.36	223300	1.7	4095	3/V19L4	—	BE160M4	BX160MB4	—	—	—	—	527700	581100	200000	438
0.39	208700	2.2	3780	3/V21L4	—	BE160M4	BX160MB4	—	—	—	—	738000	878500	1200000	448
0.40	201600	1.5	3696	3/V18ML4	—	BE160M4	BX160MB4	—	—	—	—	428000	483300	200000	428
0.41	203400	2.6	3600	3/V21L4	—	BE160M4	BX160MB4	—	—	—	—	732900	872400	1200000	448
0.42	190600	1.6	3495	3/V18ML4	—	BE160M4	BX160MB4	—	—	—	—	424600	479400	200000	428
0.45	180500	2.0	3231	3/V19L4	—	BE160M4	BX160MB4	—	—	—	—	510200	561700	200000	438
0.46	172800	1.1	3168	3/V17ML4	—	BE160M4	BX160MB4	—	—	—	—	440100	467600	150000	418
0.50	160600	1.7	2945	3/V18ML4	—	BE160M4	BX160MB4	—	—	—	—	414400	467900	200000	428
0.53	142100	1.2	2773	3/V17ML4	—	BE160M4	BX160MB4	—	—	—	—	431800	458800	150000	418
0.57	144200	2.5	2582	3/V19L4	—	BE160M4	BX160MB4	—	—	—	—	494100	544000	200000	438
0.59	137600	2.2	2464	3/V18ML4	—	BE160M4	BX160MB4	—	—	—	—	403900	456100	200000	428
0.63	129300	1.0	2343	3/V16ML4	—	BE160M4	BX160MB4	—	—	—	—	270900	303900	150000	408
0.64	125200	1.7	2295	3/V18ML4	—	BE160M4	BX160MB4	—	—	—	—	399900	451500	200000	428
0.71	119400	1.5	2065	3/V17ML4	—	BE160M4	BX160MB4	—	—	—	—	414000	439800	150000	418
0.73	98600	0.9	1994	3/V15ML3	—	BE160M4	BX160MB4	—	—	—	—	173000	207500	90000	396
0.76	106000	1.1	1920	3/V16ML4	—	BE160M4	BX160MB4	—	—	—	—	263300	295400	150000	408
0.79	106900	2.8	1848	3/V18ML4	—	BE160M4	BX160MB4	—	—	—	—	387700	437700	200000	428
0.82	98500	1.1	1785	3/V16ML4	—	BE160M4	BX160MB4	—	—	—	—	260600	292400	150000	408
0.82	99400	1.9	1780	3/V17ML4	—	BE160M4	BX160MB4	—	—	—	—	405300	430600	150000	418
0.84	101100	2.9	1748	3/V18ML4	—	BE160M4	BX160MB4	—	—	—	—	384600	434200	200000	428
0.88	85600	1.1	1662	3/V15ML3	—	BE160M4	BX160MB4	—	—	—	—	168600	202200	90000	396
0.92	81800	1.4	1589	3/V16ML3	—	BE160M4	BX160MB4	—	—	—	—	256300	287500	150000	408
0.99	85200	3.0	1473	3/V18ML4	—	BE160M4	BX160MB4	—	—	—	—	375300	423800	198800	428
1.0	72100	1.2	1400	3/V15ML3	—	BE160M4	BX160MB4	—	—	—	—	164500	197300	88000	396
1.1	70200	1.3	1329	3/V15ML3	—	BE160M4	BX160MB4	—	—	—	—	163300	195800	86400	396
1.1	68200	1.6	1324	3/V16ML3	—	BE160M4	BX160MB4	—	—	—	—	249700	280100	143900	408
1.1	73100	2.1	1365	3/V17ML3	—	BE160M4	BX160MB4	—	—	—	—	390300	414600	145400	418
1.2	69100	2.1	1215	3/V17ML3	—	BE160M4	BX160MB4	—	—	—	—	383800	407800	139800	418
1.3	59200	1.5	1120	3/V15ML3	—	BE160M4	BX160MB4	—	—	—	—	159300	191100	81600	396
1.3	60700	2.1	1134	3/V17ML3	—	BE160M4	BX160MB4	—	—	—	—	380100	403800	136600	418
1.4	56700	2.1	1059	3/V16ML3	—	BE160M4	BX160MB4	—	—	—	—	241900	271300	133600	408
1.4	58300	2.2	1024	3/V17ML3	—	BE160M4	BX160MB4	—	—	—	—	374500	397900	132100	418
1.5	56700	0.9	1009	3/V13ML3	—	BE160M4	BX160MB4	—	—	—	—	168900	197900	70100	372
1.5	56100	1.1	997	3/V14ML3	—	BE160M4	BX160MB4	—	—	—	—	156700	187900	78500	384
1.5	56100	1.6	997	3/V15ML3	—	BE160M4	BX160MB4	—	—	—	—	156700	187900	78500	396
1.6	47200	1.2	893	3/V14ML3	—	BE160M4	BX160MB4	—	—	—	—	154200	185000	75700	384
1.6	47800	2.1	893	3/V16ML3	—	BE160M4	BX160MB4	—	—	—	—	236000	264800	126200	408
1.7	46000	1.2	870	3/V13ML3	—	BE160M4	BX160MB4	—	—	—	—	165300	193700	66700	372
1.7	47200	1.7	840	3/V15ML3	—	BE160M4	BX160MB4	—	—	—	—	152900	183400	74200	396
1.7	48400	2.2	851	3/V17ML3	—	BE160M4	BX160MB4	—	—	—	—	364700	387500	124200	418
1.8	46500	0.9	827	3/V11ML3	—	BE160M4	BX160MB4	—	—	—	—	113300	115600	53300	360
1.8	44600	1.1	794	3/V14ML3	—	BE160M4	BX160MB4	—	—	—	—	151700	181900	72800	384
1.8	45200	2.2	794	3/V16ML3	—	BE160M4	BX160MB4	—	—	—	—	232200	260400	121400	408
1.8	47200	2.9	810	3/V17ML3	—	BE160M4	BX160MB4	—	—	—	—	362200	384800	122100	418
2.0	38000	1.1	720	3/V11ML3	—	BE160M4	BX160MB4	—	—	—	—	111100	113300	50900	360
2.0	39200	1.2	741	3/V13ML3	—	BE160M4	BX160MB4	—	—	—	—	161600	189300	63200	372
2.1	36700	1.2	695	3/V14ML3	—	BE160M4	BX160MB4	—	—	—	—	148800	178500	69700	384
2.2	38800	1.3	673	3/V13ML3	—	BE160M4	BX160MB4	—	—	—	—	159400	186800	61200	372
2.2	38300	1.8	665	3/V14ML3	—	BE160M4	BX160MB4	—	—	—	—	147900	177300	68600	384
2.2	38300	2.2	665	3/V15ML3	—	BE160M4	BX160MB4	—	—	—	—	147900	177300	68600	396
2.2	38100	2.2	669	3/V16ML3	—	BE160M4	BX160MB4	—	—	—	—	226500	254100	114600	408
2.3	36200	1.1	644	3/V11ML3	—	BE160M4	BX160MB4	—	—	—	—	109300	111500	49000	360
2.5	34500	1.6	579	3/V14ML3	—	BE160M4	BX160MB4	—	—	—	—	145000	173900	65500	384
2.6	32600	1.5	567	3/V13ML3	—	BE160M4	BX160MB4	—	—	—	—	155500	182200	57800	372
2.6	32200	2.5	560	3/V15ML3	—	BE160M4	BX160MB4	—	—	—	—	144300	173100	64800	396
2.7	31700	1.3	551	3/V11ML3	—	BE160M4	BX160MB4	—	—	—	—	106900	109100	46600	360
2.8	29700	1.6	516	3/V13ML3	—	BE160M4	BX160MB4	—	—	—	—	153500	179800	56100	372
2.9	29400	1.1	510	3/V11ML3	—	BE160M4	BX160MB4	—	—	—	—	105700	107900	45400	360
2.9	29700	1.9	498	3/V14ML3	—	BE160M4	BX160MB4	—	—	—	—	141900	170200	62300	384

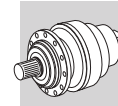

$P_1 = 11 \text{ kW}$

n_2 min ⁻¹	M_2 Nm	S	i	IE2		IE3		R_{n_2} [N]							
				MC/PC	MZ/PZ	HC	HZ	FZ							
2.9	29700	2.8	498	3/V15ML3	—	BE160M4	BX160MB4	—	—	—	141900	170200	62300	396	
3.3	25700	1.9	446	3/V14ML3	—	BE160M4	BX160MB4	—	—	—	139700	167500	60100	384	
3.3	25700	2.5	446	3/V15ML3	—	BE160M4	BX160MB4	—	—	—	139700	167500	60100	396	
3.4	24800	1.1	436	3/V10ML3	—	BE160M4	BX160MB4	—	—	—	82300	104300	43100	348	
3.4	24800	1.6	430	3/V11ML3	—	BE160M4	BX160MB4	—	—	—	103200	105300	42800	360	
3.4	25300	1.8	425	3/V13ML3	—	BE160M4	BX160MB4	—	—	—	149300	174900	52600	372	
3.7	23700	1.9	397	3/V14ML3	—	BE160M4	BX160MB4	—	—	—	137400	164800	57800	384	
3.8	23300	2.7	386	3/V15ML3	—	BE160M4	BX160MB4	—	—	—	136900	164100	57300	396	
4.0	21300	1.9	370	3/V13ML3	—	BE160M4	BX160MB4	—	—	—	146300	171500	50200	372	
8.1	11800	0.9	180	—	3/A07L2	BE160M4	BX160MB4	ME5SA4	MX5SB4	30000	37500	67500	88800	22200	325
10.5	9190	1.2	140	—	3/A07L2	BE160M4	BX160MB4	ME5SA4	MX5SB4	29300	36700	66200	87000	20400	325
11.3	8530	1.3	130	—	3/A07L2	BE160M4	BX160MB4	ME5SA4	MX5SB4	28600	35700	64600	85000	19900	325
13.4	7160	1.2	109	—	3/A07L2	BE160M4	BX160MB4	ME5SA4	MX5SB4	26900	33700	61300	80600	18800	325
16.6	5930	1.0	88.5	—	3/A06L2	BE160M4	BX160MB4	ME5SA4	MX5SB4	21000	23900	48700	56200	13600	313
16.7	5880	1.7	87.7	—	3/A07L2	BE160M4	BX160MB4	ME5SA4	MX5SB4	25100	31400	57500	75600	17500	325
18.0	5440	1.2	81.2	—	3/A06L2	BE160M4	BX160MB4	ME5SA4	MX5SB4	20400	23200	47400	54700	13200	313
21.0	4690	1.2	69.9	—	3/A06L2	BE160M4	BX160MB4	ME5SA4	MX5SB4	19400	22100	45300	52300	12600	313
21.4	4580	1.7	68.3	—	3/A07L2	BE160M4	BX160MB4	ME5SA4	MX5SB4	23100	28900	53300	70100	16100	325
24.4	4030	1.5	60.1	—	3/A06L2	BE160M4	BX160MB4	ME5SA4	MX5SB4	18400	21000	43300	50000	12000	313
25.6	3840	1.7	57.3	—	3/A07L2	BE160M4	BX160MB4	ME5SA4	MX5SB4	21800	27200	50600	66500	15200	325
26.3	3730	1.2	55.7	—	3/A06L2	BE160M4	BX160MB4	ME5SA4	MX5SB4	18000	20500	42300	48900	11700	313
28.3	3470	1.5	51.7	—	3/A06L2	BE160M4	BX160MB4	ME5SA4	MX5SB4	17500	20000	41400	47800	11400	313
29.8	3300	2.5	49.2	—	3/A07L2	BE160M4	BX160MB4	ME5SA4	MX5SB4	20700	25900	48300	63600	14400	325
31	3160	1.2	47.2	—	3/A06L2	BE160M4	BX160MB4	ME5SA4	MX5SB4	17000	19400	40300	46500	11000	313
36	2760	1.8	41.1	—	3/A06L2	BE160M4	BX160MB4	ME5SA4	MX5SB4	16200	18500	38600	44600	10500	313
42	2340	1.5	34.9	—	3/A06L2	BE160M4	BX160MB4	ME5SA4	MX5SB4	15400	17500	36800	42500	9990	313
45	2190	1.8	32.7	—	3/A06L2	BE160M4	BX160MB4	ME5SA4	MX5SB4	15000	17200	36100	41700	9780	313
53	1860	1.8	27.7	—	3/A06L2	BE160M4	BX160MB4	ME5SA4	MX5SB4	14200	16200	34300	39600	9250	313

$P_1 = 15 \text{ kW}$

n_2 min ⁻¹	M_2 Nm	S	i	IE2		IE3		R_{n_2} [N]						
				MC/PC	MZ/PZ	HC	HZ	FZ						
0.28	360300	1.1	5164	3/V19L4	—	BE160L4	BX160L4	—	—	—	545500	600600	200000	438
0.29	356100	1.6	5040	3/V21L4	—	BE160L4	BX160L4	—	—	—	769000	915300	1200000	448
0.32	341800	1.6	4550	3/V21L4	—	BE160L4	BX160L4	—	—	—	757800	902100	1200000	448
0.33	325600	0.9	4386	3/V18ML4	—	BE160L4	BX160L4	—	—	—	438600	495300	200000	428
0.33	338800	1.0	4457	3/V19L4	—	BE160L4	BX160L4	—	—	—	534200	588100	200000	438
0.36	304000	1.3	4095	3/V19L4	—	BE160L4	BX160L4	—	—	—	527700	581100	200000	438
0.39	284000	1.6	3780	3/V21L4	—	BE160L4	BX160L4	—	—	—	738000	878500	1200000	448
0.40	274400	1.1	3696	3/V18ML4	—	BE160L4	BX160L4	—	—	—	428000	483300	200000	428
0.41	276900	1.9	3600	3/V21L4	—	BE160L4	BX160L4	—	—	—	732900	872400	1200000	448
0.42	259500	1.1	3495	3/V18ML4	—	BE160L4	BX160L4	—	—	—	424600	479400	200000	428
0.45	245600	1.5	3231	3/V19L4	—	BE160L4	BX160L4	—	—	—	510200	561700	200000	438
0.50	218600	1.3	2945	3/V18ML4	—	BE160L4	BX160L4	—	—	—	414400	467900	200000	428
0.54	212500	2.5	2700	3/V21L4	—	BE160L4	BX160L4	—	—	—	703400	837300	1200000	448
0.57	196300	1.9	2582	3/V19L4	—	BE160L4	BX160L4	—	—	—	494100	544000	200000	438
0.58	193800	2.6	2520	3/V21L4	—	BE160L4	BX160L4	—	—	—	696500	829000	1200000	448
0.59	187300	1.6	2464	3/V18ML4	—	BE160L4	BX160L4	—	—	—	403900	456100	200000	428
0.64	170400	1.2	2295	3/V18ML4	—	BE160L4	BX160L4	—	—	—	399900	451500	200000	428
0.71	162500	1.1	2065	3/V17ML4	—	BE160L4	BX160L4	—	—	—	414000	439800	150000	418
0.79	145500	2.0	1848	3/V18ML4	—	BE160L4	BX160L4	—	—	—	387700	437700	200000	428
0.82	135300	1.4	1780	3/V17ML4	—	BE160L4	BX160L4	—	—	—	405300	430600	150000	418
0.84	137600	2.2	1748	3/V18ML4	—	BE160L4	BX160L4	—	—	—	384600	434200	200000	428
0.92	111400	1.0	1589	3/V16ML3	—	BE160L4	BX160L4	—	—	—	256300	287500	150000	408
0.99	115900	2.2	1473	3/V18ML4	—	BE160L4	BX160L4	—	—	—	375300	423800	198800	428
1.1	95600	0.9	1329	3/V15ML3	—	BE160L4	BX160L4	—	—	—	163300	195800	86400	396
1.1	92800	1.2	1324	3/V16ML3	—	BE160L4	BX160L4	—	—	—	249700	280100	143900	408
1.1	99400	1.5	1365	3/V17ML3	—	BE160L4	BX160L4	—	—	—	390300	414600	145400	418
1.2	94100	1.5	1215	3/V17ML3	—	BE160L4	BX160L4	—	—	—	383800	407800	139800	418
1.2	98100	2.9	1232	3/V18ML4	—	BE160L4	BX160L4	—	—	—	365900	413100	187300	428
1.3	80600	1.1	1120	3/V15ML3	—	BE160L4	BX160L4	—	—	—	159300	191100	81600	396

A

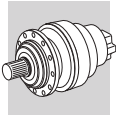

$P_1 = 15 \text{ kW}$

n_2 min ⁻¹	M_2 Nm	S	i	3/V		IE2		IE3		Rn ₂ [N]					
				IE2	IE3	IE2	IE3	MC/PC	MZ/PZ	HC	HZ	FZ			
1.3	82600	1.5	1134	3/V17ML3	—	BE160L4	BX160L4	—	—	—	—	380100	403800	136600	418
1.4	77100	1.5	1059	3/V16ML3	—	BE160L4	BX160L4	—	—	—	—	241900	271300	133600	408
1.4	79300	1.6	1024	3/V17ML3	—	BE160L4	BX160L4	—	—	—	—	374500	397900	132100	418
1.5	76300	1.2	997	3/V15ML3	—	BE160L4	BX160L4	—	—	—	—	156700	187900	78500	396
1.6	65100	1.5	893	3/V16ML3	—	BE160L4	BX160L4	—	—	—	—	236000	264800	126200	408
1.7	64300	1.3	840	3/V15ML3	—	BE160L4	BX160L4	—	—	—	—	152900	183400	74200	396
1.7	65900	1.6	851	3/V17ML3	—	BE160L4	BX160L4	—	—	—	—	364700	387500	124200	418
1.8	61500	1.6	794	3/V16ML3	—	BE160L4	BX160L4	—	—	—	—	232200	260400	121400	408
1.8	64200	2.1	810	3/V17ML3	—	BE160L4	BX160L4	—	—	—	—	362200	384800	122100	418
2.1	54200	2.6	683	3/V17ML3	—	BE160L4	BX160L4	—	—	—	—	353500	375500	115400	418
2.2	52700	0.9	673	3/V13ML3	—	BE160L4	BX160L4	—	—	—	—	159400	186800	61200	372
2.2	52100	1.3	665	3/V14ML3	—	BE160L4	BX160L4	—	—	—	—	147900	177300	68600	384
2.2	52100	1.6	665	3/V15ML3	—	BE160L4	BX160L4	—	—	—	—	147900	177300	68600	396
2.2	51800	1.6	669	3/V16ML3	—	BE160L4	BX160L4	—	—	—	—	226500	254100	114600	408
2.4	49300	2.6	608	3/V17ML3	—	BE160L4	BX160L4	—	—	—	—	347600	369300	111000	418
2.5	47000	1.1	579	3/V14ML3	—	BE160L4	BX160L4	—	—	—	—	145000	173900	65500	384
2.6	44400	1.1	567	3/V13ML3	—	BE160L4	BX160L4	—	—	—	—	155500	182200	57800	372
2.6	43900	1.9	560	3/V15ML3	—	BE160L4	BX160L4	—	—	—	—	144300	173100	64800	396
2.6	45000	2.6	567	3/V17ML3	—	BE160L4	BX160L4	—	—	—	—	344200	365700	108500	418
2.7	43200	0.9	551	3/V11ML3	—	BE160L4	BX160L4	—	—	—	—	106900	109100	46600	360
2.8	40400	1.2	516	3/V13ML3	—	BE160L4	BX160L4	—	—	—	—	153500	179800	56100	372
2.8	42000	2.6	530	3/V16ML3	—	BE160L4	BX160L4	—	—	—	—	219100	245800	106000	408
2.9	40400	1.4	498	3/V14ML3	—	BE160L4	BX160L4	—	—	—	—	141900	170200	62300	384
2.9	40400	2.0	498	3/V15ML3	—	BE160L4	BX160L4	—	—	—	—	141900	170200	62300	396
3.3	35000	1.4	446	3/V14ML3	—	BE160L4	BX160L4	—	—	—	—	139700	167500	60100	384
3.3	35000	1.9	446	3/V15ML3	—	BE160L4	BX160L4	—	—	—	—	139700	167500	60100	396
3.3	35400	2.6	446	3/V16ML3	—	BE160L4	BX160L4	—	—	—	—	213800	239800	100100	408
3.4	33700	1.2	430	3/V11ML3	—	BE160L4	BX160L4	—	—	—	—	103200	105300	42800	360
3.4	34500	1.3	425	3/V13ML3	—	BE160L4	BX160L4	—	—	—	—	149300	174900	52600	372
3.7	32200	1.4	397	3/V14ML3	—	BE160L4	BX160L4	—	—	—	—	137400	164800	57800	384
3.8	31700	2.0	386	3/V15ML3	—	BE160L4	BX160L4	—	—	—	—	136900	164100	57300	396
4.0	29000	1.4	370	3/V13ML3	—	BE160L4	BX160L4	—	—	—	—	146300	171500	50200	372
11.3	11600	1.0	130	—	3/A07L2	BE160L4	BX160L4	ME5LA4	MX5LA4	28600	35700	64600	85000	19900	325
13.4	9740	0.9	109	—	3/A07L2	BE160L4	BX160L4	ME5LA4	MX5LA4	26900	33700	61300	80600	18800	325
16.7	8000	1.3	87.7	—	3/A07L2	BE160L4	BX160L4	ME5LA4	MX5LA4	25100	31400	57500	75600	17500	325
21.4	6230	1.3	68.3	—	3/A07L2	BE160L4	BX160L4	ME5LA4	MX5LA4	23100	28900	53300	70100	16100	325
24.4	5480	1.1	60.1	—	3/A06L2	BE160L4	BX160L4	ME5LA4	MX5LA4	18400	21000	43300	50000	12000	313
25.6	5230	1.3	57.3	—	3/A07L2	BE160L4	BX160L4	ME5LA4	MX5LA4	21800	27200	50600	66500	15200	325
28.3	4720	1.1	51.7	—	3/A06L2	BE160L4	BX160L4	ME5LA4	MX5LA4	17500	20000	41400	47800	11400	313
29.8	4490	1.9	49.2	—	3/A07L2	BE160L4	BX160L4	ME5LA4	MX5LA4	20700	25900	48300	63600	14400	325
35	3790	2.5	41.5	—	3/A07L2	BE160L4	BX160L4	ME5LA4	MX5LA4	19500	24400	45900	60400	13600	325
36	3750	1.3	41.1	—	3/A06L2	BE160L4	BX160L4	ME5LA4	MX5LA4	16200	18500	38600	44600	10500	313
42	3180	1.1	34.9	—	3/A06L2	BE160L4	BX160L4	ME5LA4	MX5LA4	15400	17500	36800	42500	9990	313
45	2980	1.3	32.7	—	3/A06L2	BE160L4	BX160L4	ME5LA4	MX5LA4	15000	17200	36100	41700	9780	313
45	2950	2.7	32.3	—	3/A07L2	BE160L4	BX160L4	ME5LA4	MX5LA4	18000	22500	42600	56000	12500	325
53	2530	1.3	27.7	—	3/A06L2	BE160L4	BX160L4	ME5LA4	MX5LA4	14200	16200	34300	39600	9250	313
54	2470	2.7	27.1	—	3/A07L2	BE160L4	BX160L4	ME5LA4	MX5LA4	17000	21200	40400	53100	11800	325

$P_1 = 18.5 \text{ kW}$

n_2 min ⁻¹	M_2 Nm	S	i	3/V		IE2		IE3		Rn ₂ [N]					
				IE2	IE3	IE2	IE3	MC/PC	MZ/PZ	HC	HZ	FZ			
0.28	444800	0.9	5164	3/V19L4	—	BE180M4	BX180M4	—	—	—	—	545500	600600	200000	438
0.29	439700	1.3	5040	3/V21L4	—	BE180M4	BX180M4	—	—	—	—	769000	915300	1200000	448
0.32	422100	1.3	4550	3/V21L4	—	BE180M4	BX180M4	—	—	—	—	757800	902100	1200000	448
0.36	375300	1.0	4095	3/V19L4	—	BE180M4	BX180M4	—	—	—	—	527700	581100	200000	438
0.39	350600	1.3	3780	3/V21L4	—	BE180M4	BX180M4	—	—	—	—	738000	878500	1200000	448
0.41	341900	1.6	3600	3/V21L4	—	BE180M4	BX180M4	—	—	—	—	732900	872400	1200000	448
0.42	320400	0.9	3495	3/V18ML4	—	BE180M4	BX180M4	—	—	—	—	424600	479400	200000	428
0.45	303300	1.2	3231	3/V19L4	—	BE180M4	BX180M4	—	—	—	—	510200	561700	200000	438
0.50	269900	1.0	2945	3/V18ML4	—	BE180M4	BX180M4	—	—	—	—	414400	467900	200000	428
0.54	262400	2.0	2700	3/V21L4	—	BE180M4	BX180M4	—	—	—	—	703400	837300	1200000	448

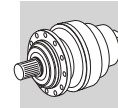

$P_1 = 18.5 \text{ kW}$

n ₂ min ⁻¹	M ₂ Nm	S	i	IE2		IE3		Rn ₂ [N]					📄				
				IE2	IE3	IE2	IE3	MC/PC	MZ/PZ	HC	HZ	FZ					
0.57	242400	1.5	2582	3/V19L4	—	BE180M4	BX180M4	—	—	—	—	494100	544000	200000	438		
0.58	239300	2.1	2520	3/V21L4	—	BE180M4	BX180M4	—	—	—	—	696500	829000	1200000	448		
0.59	231300	1.3	2464	3/V18ML4	—	BE180M4	BX180M4	—	—	—	—	403900	456100	200000	428		
0.64	210400	1.0	2295	3/V18ML4	—	BE180M4	BX180M4	—	—	—	—	399900	451500	200000	428		
0.64	221100	2.5	2275	3/V21L4	—	BE180M4	BX180M4	—	—	—	—	686400	817000	1200000	448		
0.78	183700	2.5	1890	3/V21L4	—	BE180M4	BX180M4	—	—	—	—	668500	795700	1200000	448		
0.79	179600	1.7	1848	3/V18ML4	—	BE180M4	BX180M4	—	—	—	—	387700	437700	200000	428		
0.81	178900	3.0	1800	3/V21L4	—	BE180M4	BX180M4	—	—	—	—	663800	790100	1200000	448		
0.82	167100	1.1	1780	3/V17ML4	—	BE180M4	BX180M4	—	—	—	—	405300	430600	150000	418		
0.84	169900	1.8	1748	3/V18ML4	—	BE180M4	BX180M4	—	—	—	—	384600	434200	200000	428		
0.99	143100	1.8	1473	3/V18ML4	—	BE180M4	BX180M4	—	—	—	—	375300	423800	198800	428		
1.1	114600	1.0	1324	3/V16ML3	—	BE180M4	BX180M4	—	—	—	—	249700	280100	143900	408		
1.1	122800	1.3	1365	3/V17ML3	—	BE180M4	BX180M4	—	—	—	—	390300	414600	145400	418		
1.2	116200	1.2	1215	3/V17ML3	—	BE180M4	BX180M4	—	—	—	—	383800	407800	139800	418		
1.2	121100	2.4	1232	3/V18ML4	—	BE180M4	BX180M4	—	—	—	—	365900	413100	187300	428		
1.3	102000	1.3	1134	3/V17ML3	—	BE180M4	BX180M4	—	—	—	—	380100	403800	136600	418		
1.3	114500	2.5	1165	3/V18ML4	—	BE180M4	BX180M4	—	—	—	—	363000	409800	183800	428		
1.4	95200	1.2	1059	3/V16ML3	—	BE180M4	BX180M4	—	—	—	—	241900	271300	133600	408		
1.4	97900	1.3	1024	3/V17ML3	—	BE180M4	BX180M4	—	—	—	—	374500	397900	132100	418		
1.5	94200	0.9	997	3/V15ML3	—	BE180M4	BX180M4	—	—	—	—	156700	187900	78500	396		
1.5	96500	2.5	982	3/V18ML4	—	BE180M4	BX180M4	—	—	—	—	354200	399900	173600	428		
1.6	80300	1.3	893	3/V16ML3	—	BE180M4	BX180M4	—	—	—	—	236000	264800	126200	408		
1.7	79400	1.0	840	3/V15ML3	—	BE180M4	BX180M4	—	—	—	—	152900	183400	74200	396		
1.7	81400	1.3	851	3/V17ML3	—	BE180M4	BX180M4	—	—	—	—	364700	387500	124200	418		
1.8	75900	1.3	794	3/V16ML3	—	BE180M4	BX180M4	—	—	—	—	232200	260400	121400	408		
1.8	79300	1.7	810	3/V17ML3	—	BE180M4	BX180M4	—	—	—	—	362200	384800	122100	418		
1.9	75200	2.5	765	3/V18ML4	—	BE180M4	BX180M4	—	—	—	—	341800	385900	159800	428		
2.1	66900	2.1	683	3/V17ML3	—	BE180M4	BX180M4	—	—	—	—	353500	375500	115400	418		
2.2	64400	1.1	665	3/V14ML3	—	BE180M4	BX180M4	—	—	—	—	147900	177300	68600	384		
2.2	64400	1.3	665	3/V15ML3	—	BE180M4	BX180M4	—	—	—	—	147900	177300	68600	396		
2.2	64000	1.3	669	3/V16ML3	—	BE180M4	BX180M4	—	—	—	—	226500	254100	114600	408		
2.4	60900	2.1	608	3/V17ML3	—	BE180M4	BX180M4	—	—	—	—	347600	369300	111000	418		
2.5	58000	0.9	579	3/V14ML3	—	BE180M4	BX180M4	—	—	—	—	145000	173900	65500	384		
2.6	54200	1.5	560	3/V15ML3	—	BE180M4	BX180M4	—	—	—	—	144300	173100	64800	396		
2.6	55500	2.1	567	3/V17ML3	—	BE180M4	BX180M4	—	—	—	—	344200	365700	108500	418		
2.8	49900	1.0	516	3/V13ML3	—	BE180M4	BX180M4	—	—	—	—	153500	179800	56100	372		
2.8	51900	2.1	530	3/V16ML3	—	BE180M4	BX180M4	—	—	—	—	219100	245800	106000	408		
2.9	49900	1.2	498	3/V14ML3	—	BE180M4	BX180M4	—	—	—	—	141900	170200	62300	384		
2.9	49900	1.7	498	3/V15ML3	—	BE180M4	BX180M4	—	—	—	—	141900	170200	62300	396		
2.9	51300	2.5	512	3/V17ML3	—	BE180M4	BX180M4	—	—	—	—	339200	360400	104800	418		
3.3	43200	1.1	446	3/V14ML3	—	BE180M4	BX180M4	—	—	—	—	139700	167500	60100	384		
3.3	43200	1.5	446	3/V15ML3	—	BE180M4	BX180M4	—	—	—	—	139700	167500	60100	396		
3.3	43700	2.1	446	3/V16ML3	—	BE180M4	BX180M4	—	—	—	—	213800	239800	100100	408		
3.4	41600	0.9	430	3/V11ML3	—	BE180M4	BX180M4	—	—	—	—	103200	105300	42800	360		
3.4	42600	1.1	425	3/V13ML3	—	BE180M4	BX180M4	—	—	—	—	149300	174900	52600	372		
3.4	42600	2.5	425	3/V17ML3	—	BE180M4	BX180M4	—	—	—	—	330400	351000	98500	418		
3.6	41500	2.9	405	3/V17ML3	—	BE180M4	BX180M4	—	—	—	—	328100	348500	96900	418		
3.7	39800	1.2	397	3/V14ML3	—	BE180M4	BX180M4	—	—	—	—	137400	164800	57800	384		
3.7	39800	2.5	397	3/V16ML3	—	BE180M4	BX180M4	—	—	—	—	210300	235900	96300	408		
3.8	39100	1.6	386	3/V15ML3	—	BE180M4	BX180M4	—	—	—	—	136900	164100	57300	396		
4.0	35800	1.1	370	3/V13ML3	—	BE180M4	BX180M4	—	—	—	—	146300	171500	50200	372		
16.7	9880	1.0	87.7	—	3/A07L2	BE180M4	BX180M4	—	—	—	—	25100	31400	57500	75600	17500	325
21.4	7700	1.0	68.3	—	3/A07L2	BE180M4	BX180M4	—	—	—	—	23100	28900	53300	70100	16100	325
25.6	6460	1.0	57.3	—	3/A07L2	BE180M4	BX180M4	—	—	—	—	21800	27200	50600	66500	15200	325
29.8	5540	1.5	49.2	—	3/A07L2	BE180M4	BX180M4	—	—	—	—	20700	25900	48300	63600	14400	325
35	4680	2.1	41.5	—	3/A07L2	BE180M4	BX180M4	—	—	—	—	19500	24400	45900	60400	13600	325
36	4630	1.1	41.1	—	3/A06L2	BE180M4	BX180M4	—	—	—	—	16200	18500	38600	44600	10500	313
45	3680	1.1	32.7	—	3/A06L2	BE180M4	BX180M4	—	—	—	—	15000	17200	36100	41700	9780	313
45	3640	2.2	32.3	—	3/A07L2	BE180M4	BX180M4	—	—	—	—	18000	22500	42600	56000	12500	325
53	3120	1.1	27.7	—	3/A06L2	BE180M4	BX180M4	—	—	—	—	14200	16200	34300	39600	9250	313
54	3050	2.2	27.1	—	3/A07L2	BE180M4	BX180M4	—	—	—	—	17000	21200	40400	53100	11800	325

A

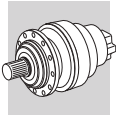

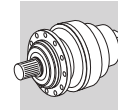

$P_1 = 22 \text{ kW}$

n_2 min ⁻¹	M_2 Nm	S	i	[Image]		IE2		IE3		Rn ₂ [N]					[Icon]
				[Image]	[Image]	[Image]	[Image]	MC/PC	MZ/PZ	HC	HZ	FZ			
0.29	519600	1.1	5040	3/V21L4	—	BE180L4	BX180L4	—	—	—	—	769000	915300	1200000	448
0.32	498800	1.1	4550	3/V21L4	—	BE180L4	BX180L4	—	—	—	—	757800	902100	1200000	448
0.39	414400	1.1	3780	3/V21L4	—	BE180L4	BX180L4	—	—	—	—	738000	878500	1200000	448
0.41	404100	1.3	3600	3/V21L4	—	BE180L4	BX180L4	—	—	—	—	732900	872400	1200000	448
0.45	358400	1.0	3231	3/V19L4	—	BE180L4	BX180L4	—	—	—	—	510200	561700	200000	438
0.54	310100	1.7	2700	3/V21L4	—	BE180L4	BX180L4	—	—	—	—	703400	837300	1200000	448
0.57	286400	1.3	2582	3/V19L4	—	BE180L4	BX180L4	—	—	—	—	494100	544000	200000	438
0.58	282800	1.8	2520	3/V21L4	—	BE180L4	BX180L4	—	—	—	—	696500	829000	1200000	448
0.59	273300	1.1	2464	3/V18ML4	—	BE180L4	BX180L4	—	—	—	—	403900	456100	200000	428
0.64	261300	2.1	2275	3/V21L4	—	BE180L4	BX180L4	—	—	—	—	686400	817000	1200000	448
0.78	217100	2.1	1890	3/V21L4	—	BE180L4	BX180L4	—	—	—	—	668500	795700	1200000	448
0.79	212200	1.4	1848	3/V18ML4	—	BE180L4	BX180L4	—	—	—	—	387700	437700	200000	428
0.81	211400	2.5	1800	3/V21L4	—	BE180L4	BX180L4	—	—	—	—	663800	790100	1200000	448
0.82	197500	0.9	1780	3/V17ML4	—	BE180L4	BX180L4	—	—	—	—	405300	430600	150000	418
0.84	200800	1.5	1748	3/V18ML4	—	BE180L4	BX180L4	—	—	—	—	384600	434200	200000	428
0.97	178200	2.9	1517	3/V21L4	—	BE180L4	BX180L4	—	—	—	—	647800	771000	1200000	448
0.99	169200	1.5	1473	3/V18ML4	—	BE180L4	BX180L4	—	—	—	—	375300	423800	198800	428
1.1	145100	1.1	1365	3/V17ML3	—	BE180L4	BX180L4	—	—	—	—	390300	414600	145400	418
1.2	137300	1.1	1215	3/V17ML3	—	BE180L4	BX180L4	—	—	—	—	383800	407800	139800	418
1.2	143100	2.0	1232	3/V18ML4	—	BE180L4	BX180L4	—	—	—	—	365900	413100	187300	428
1.2	148000	2.9	1260	3/V21L4	—	BE180L4	BX180L4	—	—	—	—	630800	750900	1138800	448
1.3	120500	1.1	1134	3/V17ML3	—	BE180L4	BX180L4	—	—	—	—	380100	403800	136600	418
1.3	135300	2.1	1165	3/V18ML4	—	BE180L4	BX180L4	—	—	—	—	363000	409800	183800	428
1.4	112600	1.0	1059	3/V16ML3	—	BE180L4	BX180L4	—	—	—	—	241900	271300	133600	408
1.4	115700	1.1	1024	3/V17ML3	—	BE180L4	BX180L4	—	—	—	—	374500	397900	132100	418
1.5	114100	2.1	982	3/V18ML4	—	BE180L4	BX180L4	—	—	—	—	354200	399900	173600	428
1.6	94900	1.1	893	3/V16ML3	—	BE180L4	BX180L4	—	—	—	—	236000	264800	126200	408
1.7	96200	1.1	851	3/V17ML3	—	BE180L4	BX180L4	—	—	—	—	364700	387500	124200	418
1.8	89700	1.1	794	3/V16ML3	—	BE180L4	BX180L4	—	—	—	—	232200	260400	121400	408
1.8	93700	1.4	810	3/V17ML3	—	BE180L4	BX180L4	—	—	—	—	362200	384800	122100	418
1.9	88900	2.1	765	3/V18ML4	—	BE180L4	BX180L4	—	—	—	—	341800	385900	159800	428
2.1	79000	1.8	683	3/V17ML3	—	BE180L4	BX180L4	—	—	—	—	353500	375500	115400	418
2.2	76100	1.1	665	3/V15ML3	—	BE180L4	BX180L4	—	—	—	—	147900	177300	68600	396
2.2	75600	1.1	669	3/V16ML3	—	BE180L4	BX180L4	—	—	—	—	226500	254100	114600	408
2.4	72000	1.8	608	3/V17ML3	—	BE180L4	BX180L4	—	—	—	—	347600	369300	111000	418
2.6	64000	1.3	560	3/V15ML3	—	BE180L4	BX180L4	—	—	—	—	144300	173100	64800	396
2.6	65600	1.8	567	3/V17ML3	—	BE180L4	BX180L4	—	—	—	—	344200	365700	108500	418
2.8	61300	1.8	530	3/V16ML3	—	BE180L4	BX180L4	—	—	—	—	219100	245800	106000	408
2.9	59000	1.0	498	3/V14ML3	—	BE180L4	BX180L4	—	—	—	—	141900	170200	62300	384
2.9	59000	1.4	498	3/V15ML3	—	BE180L4	BX180L4	—	—	—	—	141900	170200	62300	396
2.9	60600	2.1	512	3/V17ML3	—	BE180L4	BX180L4	—	—	—	—	339200	360400	104800	418
3.3	51000	0.9	446	3/V14ML3	—	BE180L4	BX180L4	—	—	—	—	139700	167500	60100	384
3.3	51000	1.3	446	3/V15ML3	—	BE180L4	BX180L4	—	—	—	—	139700	167500	60100	396
3.3	51600	1.8	446	3/V16ML3	—	BE180L4	BX180L4	—	—	—	—	213800	239800	100100	408
3.4	50300	0.9	425	3/V13ML3	—	BE180L4	BX180L4	—	—	—	—	149300	174900	52600	372
3.4	50300	2.1	425	3/V17ML3	—	BE180L4	BX180L4	—	—	—	—	330400	351000	98500	418
3.6	49000	2.4	405	3/V17ML3	—	BE180L4	BX180L4	—	—	—	—	328100	348500	96900	418
3.7	47000	1.0	397	3/V14ML3	—	BE180L4	BX180L4	—	—	—	—	137400	164800	57800	384
3.7	47000	2.1	397	3/V16ML3	—	BE180L4	BX180L4	—	—	—	—	210300	235900	96300	408
3.8	46200	1.4	386	3/V15ML3	—	BE180L4	BX180L4	—	—	—	—	136900	164100	57300	396
4.0	42300	0.9	370	3/V13ML3	—	BE180L4	BX180L4	—	—	—	—	146300	171500	50200	372
29.8	6550	1.3	49.2	—	3/A07L2	BE180L4	BX180L4	—	—	20700	25900	48300	63600	14400	325
35	5530	1.7	41.5	—	3/A07L2	BE180L4	BX180L4	—	—	19500	24400	45900	60400	13600	325
45	4350	0.9	32.7	—	3/A06L2	BE180L4	BX180L4	—	—	15000	17200	36100	41700	9780	313
45	4300	1.8	32.3	—	3/A07L2	BE180L4	BX180L4	—	—	18000	22500	42600	56000	12500	325
53	3690	0.9	27.7	—	3/A06L2	BE180L4	BX180L4	—	—	14200	16200	34300	39600	9250	313
54	3610	1.8	27.1	—	3/A07L2	BE180L4	BX180L4	—	—	17000	21200	40400	53100	11800	325



25.3 RATING CHARTS FOR INLINE UNITS 300M L

Reading the rating chart.

311M L  356							49210 Nm						
n_1 min ⁻¹		i	n_2 min ⁻¹	M_{n2} Nm	P_{n1} kW	P (IEC) 	MC	MZ	Rn_2 [N]			$M_{2\ max}$ Nm	
							HC/PC	HZ/PZ	FZ				
500	311ML1	4.09	122	23100	200	200 ... 250	—	—	46200	59000	13100	58300	
	311ML1	5.25	95	24300	200	200 ... 250	—	—	49800	63600	14200	58300	
	311ML1	6.23	80	24700	200	200 ... 250	—	—	52500	66900	15100	58300	
	311ML2	14.0	36	26800	106	180 ... 250	—	—	66900	85400	19800	58300	
	311ML2	16.7	29.9	29000	97	180 ... 250	—	—	70600	90000	20900	58300	
	311ML2	18.0	27.8	31400	97	180 ... 250	—	—	72100	92000	21500	58300	
	311ML2	21.5	23.3	28100	73	180 ... 250	—	—	76100	97000	22800	58300	
	311ML2	25.5	19.6	28400	62	180 ... 250	—	—	80100	100000	24100	58300	

 The rated torque of the gearbox, independent of installed mechanical power

1	Reference torque	8	Frame size of available IEC motor
2	Gearbox drive speed	9	Permitted overhung loading on output shaft, based on: - service factor $f_S=1$ - 10000 h theoretical lifetime - speed of output n_2
3	Frame size of the in-line gear unit	9	For forces not applied at shaft midpoint, see diagrams provided in the specific gearbox overall dimensioning pages
4	Gear ratio	10	Maximum torque
5	Gearbox output speed	11	Dimensions page
6	Gearbox rated output torque based on: - service factor $f_S=1$ - 10000 h theoretical lifetime		
7	Gearbox rated input power, based on: - service factor $f_S=1$ - 10000 h theoretical lifetime		

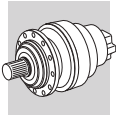

B



300 L



1250 Nm

n ₁ min ⁻¹		i	n ₂ min ⁻¹	M _{n2} Nm	P _{n1} kW	P (IEC) 	Rn ₂ [N]					M _{2 max} Nm
							MC/PC	MZ/PZ	HC	HZ	FZ	
1500	300L1	3.48	431	470	20.0	71 ... 132	1850	1850	6950	8080	1060	2000
	300L1	4.26	352	490	18.8	71 ... 132	1980	1980	7390	8590	1130	2400
	300L1	5.77	260	470	13.3	71 ... 132	2190	2190	8090	9410	1250	2400
	300L1	7.20	208	410	9.2	71 ... 132	2360	2360	8650	10100	1350	2400
	300L1	9.00	167	320	5.7	71 ... 132	2540	2540	9240	10700	1450	2400
	300L2	12.1	124	680	9.4	71 ... 132	2810	2810	10100	11800	1600	2000
	300L2	14.8	101	720	8.1	71 ... 132	3010	3010	10700	12500	1720	2000
	300L2	18.2	83	750	6.9	71 ... 132	3220	3220	11400	13300	1840	2400
	300L2	20.1	75	640	5.3	71 ... 132	3320	3320	11800	13700	1900	2000
	300L2	24.6	61	800	5.5	71 ... 132	3560	3560	12500	14500	2030	2400
	300L2	30.7	49	840	4.6	71 ... 132	3830	3830	13400	15500	2190	2400
	300L2	33.3	45	650	3.3	71 ... 132	3940	3940	13700	15900	2250	2400
	300L2	38.4	39	840	3.7	71 ... 132	4130	4130	14300	16600	2360	2400
	300L2	41.5	36	650	2.6	71 ... 132	4240	4240	14600	17000	2420	2400
	300L2	51.9	28.9	650	2.1	71 ... 132	4560	4560	15600	18200	2610	2400
	300L2	64.8	23.1	550	1.4	71 ... 132	4910	4910	16700	19400	2810	2400
	300L3	51.6	29.1	850	2.8	71 ... 132	4560	4560	15600	18200	2600	2000
	300L3	63.2	23.7	850	2.3	71 ... 132	4870	4870	16600	19300	2780	2400
	300L3	69.9	21.5	650	1.6	71 ... 132	5040	5040	17100	19900	2880	2000
	300L3	77.5	19.4	850	1.9	71 ... 132	5220	5220	17600	20500	2980	2400
	300L3	85.6	17.5	850	1.7	71 ... 132	5390	5390	18200	21100	3080	2400
	300L3	105	14.3	860	1.4	71 ... 132	5770	5770	19300	22500	3300	2400
	300L3	116	13.0	650	0.97	71 ... 132	5960	5960	19900	23100	3410	2400
	300L3	131	11.5	860	1.1	71 ... 132	6210	6210	20600	24000	3550	2400
	300L3	142	10.6	860	1.0	71 ... 132	6380	6380	21100	24600	3650	2400
	300L3	177	8.5	880	0.86	71 ... 132	6500	6500	21500	25000	3920	2400
	300L3	192	7.8	650	0.58	71 ... 132	6500	6500	21500	25000	4030	2400
	300L3	221	6.8	910	0.71	71 ... 132	6500	6500	21500	25000	4230	2400
	300L3	240	6.3	650	0.47	71 ... 132	6500	6500	21500	25000	4340	2400
	300L3	299	5.0	650	0.37	71 ... 132	6500	6500	21500	25000	4670	2400
	300L3	374	4.0	670	0.31	71 ... 132	6710	6710	22200	25800	5030	2400
	300L4	330	4.5	970	0.52	71 ... 132	6590	6590	21800	25300	4830	2400
	300L4	403	3.7	680	0.30	71 ... 132	6780	6780	22400	26100	5160	2400
	300L4	447	3.4	1020	0.40	71 ... 132	6880	6880	22800	26500	5340	2400
	300L4	494	3.0	1030	0.37	71 ... 132	6980	6980	23100	26800	5520	2400
	300L4	558	2.7	1060	0.34	71 ... 132	7100	7100	23500	27300	5750	2400
	300L4	616	2.4	1070	0.31	71 ... 132	7200	7200	23800	27700	5950	2400
	300L4	755	2.0	1110	0.26	71 ... 132	7420	7420	24500	28500	6360	2400
	300L4	819	1.8	1130	0.24	71 ... 132	7500	7500	24800	28900	6540	2400
	300L4	942	1.6	1160	0.22	71 ... 132	7650	7650	25300	29400	6850	2400
	300L4	1022	1.5	1170	0.20	71 ... 132	7740	7740	25600	29800	7040	2400
	300L4	1108	1.4	810	0.13	71 ... 132	7830	7830	25900	30100	7230	2400
	300L4	1275	1.2	1220	0.17	71 ... 132	7990	7990	26400	30700	7580	2400
	300L4	1383	1.1	850	0.11	71 ... 132	8090	8090	26700	31100	7790	2400
	300L4	1591	0.94	1250	0.14	71 ... 132	8250	8250	27300	31700	8000	2400
300L4	1725	0.87	860	0.09	71 ... 132	8350	8350	27600	32100	8000	2400	
300L4	2153	0.70	860	0.07	71 ... 132	8610	8610	28500	33100	8000	2400	
300L4	2692	0.56	1000	0.07	71 ... 132	8890	8890	29400	34000	8000	2400	
1000	300L1	3.48	287	530	16.5	71 ... 132	2120	2120	7850	9130	1210	2000
	300L1	4.26	235	560	14.1	71 ... 132	2270	2270	8340	9700	1300	2400
	300L1	5.77	173	530	10.0	71 ... 132	2510	2510	9140	10600	1430	2400
	300L1	7.20	139	460	6.9	71 ... 132	2700	2700	9760	11400	1540	2400
	300L1	9.00	111	360	4.3	71 ... 132	2910	2910	10400	12100	1660	2400
	300L2	12.1	83	730	6.7	71 ... 132	3220	3220	11400	13300	1840	2000
	300L2	14.8	67	790	5.9	71 ... 132	3440	3440	12100	14100	1970	2000
	300L2	18.2	55	820	5.0	71 ... 132	3680	3680	12900	15000	2100	2400
	300L2	20.1	50	650	3.6	71 ... 132	3810	3810	13300	15400	2170	2000
	300L2	24.6	41	840	3.8	71 ... 132	4070	4070	14100	16400	2330	2400
	300L2	30.7	33	850	3.1	71 ... 132	4380	4380	15100	17500	2500	2400
	300L2	33.3	30	650	2.2	71 ... 132	4500	4500	15500	18000	2570	2400
	300L2	38.4	26.1	850	2.5	71 ... 132	4720	4720	16100	18800	2700	2400

B

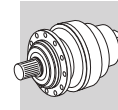

300 L	252	1250 Nm
--------------	-----	----------------

n ₁ min ⁻¹		i	n ₂ min ⁻¹	M _{n2} Nm	P _{n1} kW	P (IEC)	Rn ₂ [N]					M _{2 max} Nm
							MC/PC	MZ/PZ	HC	HZ	FZ	
1000	300L2	41.5	24.1	650	1.7	71 ... 132	4850	4850	16500	19200	2770	2400
	300L2	51.9	19.3	650	1.4	71 ... 132	5220	5220	17700	20500	2980	2400
	300L2	64.8	15.4	550	0.94	71 ... 132	5620	5620	18900	21900	3210	2400
	300L3	51.6	19.4	850	1.9	71 ... 132	5210	5210	17600	20500	2980	2000
	300L3	63.2	15.8	850	1.5	71 ... 132	5580	5580	18700	21800	3190	2400
	300L3	69.9	14.3	650	1.1	71 ... 132	5770	5770	19300	22500	3290	2000
	300L3	77.5	12.9	860	1.3	71 ... 132	5970	5970	19900	23200	3410	2400
	300L3	85.6	11.7	860	1.2	71 ... 132	6170	6170	20500	23900	3530	2400
	300L3	105	9.5	870	0.95	71 ... 132	6500	6500	21500	25000	3770	2400
	300L3	116	8.6	650	0.64	71 ... 132	6500	6500	21500	25000	3900	2400
	300L3	131	7.6	890	0.78	71 ... 132	6500	6500	21500	25000	4060	2400
	300L3	142	7.0	900	0.73	71 ... 132	6500	6500	21500	25000	4170	2400
	300L3	177	5.6	930	0.60	71 ... 132	6500	6500	21500	25000	4490	2400
	300L3	192	5.2	650	0.39	71 ... 132	6500	6500	21500	25000	4620	2400
	300L3	221	4.5	970	0.50	71 ... 132	6590	6590	21800	25400	4840	2400
	300L3	240	4.2	670	0.32	71 ... 132	6670	6670	22100	25700	4970	2400
	300L3	299	3.3	700	0.27	71 ... 132	6880	6880	22800	26500	5350	2400
	300L3	374	2.7	720	0.22	71 ... 132	7110	7110	23500	27300	5760	2400
	300L4	330	3.0	1040	0.37	71 ... 132	6980	6980	23100	26900	5530	2400
	300L4	403	2.5	730	0.21	71 ... 132	7180	7180	23800	27600	5910	2400
	300L4	447	2.2	1090	0.29	71 ... 132	7290	7290	24100	28000	6120	2400
	300L4	494	2.0	1110	0.27	71 ... 132	7400	7400	24500	28400	6320	2400
	300L4	558	1.8	1130	0.24	71 ... 132	7530	7530	24900	28900	6590	2400
	300L4	616	1.6	1150	0.22	71 ... 132	7630	7630	25200	29400	6810	2400
	300L4	755	1.3	1190	0.19	71 ... 132	7860	7860	26000	30200	7280	2400
	300L4	819	1.2	1210	0.17	71 ... 132	7950	7950	26300	30600	7480	2400
	300L4	942	1.1	1240	0.16	71 ... 132	8110	8110	26800	31200	7840	2400
	300L4	1022	0.98	1250	0.14	71 ... 132	8210	8210	27100	31600	8000	2400
	300L4	1108	0.90	860	0.09	71 ... 132	8300	8300	27500	31900	8000	2400
	300L4	1275	0.78	1250	0.12	71 ... 132	8470	8470	28000	32600	8000	2400
	300L4	1383	0.72	860	0.07	71 ... 132	8570	8570	28300	33000	8000	2400
	300L4	1591	0.63	1250	0.09	71 ... 132	8740	8740	28900	33600	8000	2400
	300L4	1725	0.58	860	0.06	71 ... 132	8840	8840	29300	34000	8000	2400
	300L4	2153	0.46	860	0.05	71 ... 132	9130	9130	30200	34000	8000	2400
	300L4	2692	0.37	1000	0.04	71 ... 132	9420	9420	31000	34000	8000	2400
500	300L1	3.48	144	650	10.2	71 ... 132	2670	2670	9670	11200	1530	2000
	300L1	4.26	117	690	8.7	71 ... 132	2860	2860	10300	11900	1630	2400
	300L1	5.77	87	630	5.9	71 ... 132	3160	3160	11200	13100	1810	2400
	300L1	7.20	69	530	4.0	71 ... 132	3410	3410	12000	14000	1950	2400
	300L1	9.00	56	370	2.2	71 ... 132	3670	3670	12900	14900	2100	2400
	300L2	12.1	41	730	3.4	71 ... 132	4050	4050	14100	16300	2310	2000
	300L2	14.8	34	840	3.2	71 ... 132	4340	4340	14900	17400	2480	2000
	300L2	18.2	27.5	850	2.6	71 ... 132	4640	4640	15900	18500	2650	2400
	300L2	20.1	24.9	650	1.8	71 ... 132	4800	4800	16400	19000	2740	2000
	300L2	24.6	20.3	850	1.9	71 ... 132	5130	5130	17400	20200	2930	2400
	300L2	30.7	16.3	850	1.5	71 ... 132	5520	5520	18600	21600	3160	2400
	300L2	33.3	15.0	650	1.1	71 ... 132	5680	5680	19000	22100	3240	2400
	300L2	38.4	13.0	860	1.2	71 ... 132	5950	5950	19900	23100	3400	2400
	300L2	41.5	12.0	650	0.87	71 ... 132	6110	6110	20300	23600	3490	2400
	300L2	51.9	9.6	650	0.70	71 ... 132	6500	6500	21500	25000	3760	2400
	300L2	64.8	7.7	550	0.47	71 ... 132	6500	6500	21500	25000	4050	2400
	300L3	51.6	9.7	860	0.96	71 ... 132	6500	6500	21500	25000	3750	2000
	300L3	63.2	7.9	890	0.81	71 ... 132	6500	6500	21500	25000	4020	2400
	300L3	69.9	7.2	650	0.53	71 ... 132	6500	6500	21500	25000	4150	2000
	300L3	77.5	6.5	920	0.68	71 ... 132	6500	6500	21500	25000	4300	2400
	300L3	85.6	5.8	930	0.62	71 ... 132	6500	6500	21500	25000	4440	2400
	300L3	105	4.8	960	0.52	71 ... 132	6540	6540	21600	25200	4750	2400
	300L3	116	4.3	670	0.33	71 ... 132	6640	6640	22000	25500	4910	2400
	300L3	131	3.8	990	0.44	71 ... 132	6750	6750	22300	26000	5120	2400
	300L3	142	3.5	1010	0.41	71 ... 132	6830	6830	22600	26300	5260	2400

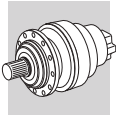

B



300 L



1250 Nm



n ₁ min ⁻¹		i	n ₂ min ⁻¹	M _{n2} Nm	P _{n1} kW	P (IEC) 	Rn ₂ [N]					M ₂ max Nm
							MC/PC	MZ/PZ	HC	HZ	FZ	
500	300L3	177	2.8	1050	0.34	71 ... 132	7050	7050	23300	27100	5660	2400
	300L3	192	2.6	730	0.22	71 ... 132	7130	7130	23600	27400	5820	2400
	300L3	221	2.3	1090	0.28	71 ... 132	7280	7280	24100	28000	6090	2400
	300L3	240	2.1	750	0.18	71 ... 132	7360	7360	24400	28300	6260	2400
	300L3	299	1.7	780	0.15	71 ... 132	7600	7600	25100	29200	6740	2400
	300L3	374	1.3	820	0.13	71 ... 132	7850	7850	26000	30200	7260	2400
	300L4	330	1.5	1170	0.21	71 ... 132	7710	7710	25500	29700	6970	2400
	300L4	403	1.2	830	0.12	71 ... 132	7930	7930	26200	30500	7450	2400
	300L4	447	1.1	1230	0.16	71 ... 132	8050	8050	26600	31000	7710	2400
	300L4	494	1.0	1250	0.15	71 ... 132	8170	8170	27000	31400	7970	2400
	300L4	558	0.90	1250	0.13	71 ... 132	8310	8310	27500	32000	8000	2400
	300L4	616	0.81	1250	0.12	71 ... 132	8430	8430	27900	32400	8000	2400
	300L4	755	0.66	1250	0.10	71 ... 132	8680	8680	28700	33400	8000	2400
	300L4	819	0.61	1250	0.09	71 ... 132	8780	8780	29000	33800	8000	2400
	300L4	942	0.53	1250	0.08	71 ... 132	8960	8960	29600	34000	8000	2400
	300L4	1022	0.49	1250	0.07	71 ... 132	9060	9060	30000	34000	8000	2400
	300L4	1108	0.45	860	0.05	71 ... 132	9160	9160	30300	34000	8000	2400
	300L4	1275	0.39	1250	0.06	71 ... 132	9350	9350	30900	34000	8000	2400
	300L4	1383	0.36	860	0.04	71 ... 132	9460	9460	31000	34000	8000	2400
	300L4	1591	0.31	1250	0.05	71 ... 132	9650	9650	31000	34000	8000	2400
	300L4	1725	0.29	860	0.03	71 ... 132	9760	9760	31000	34000	8000	2400
	300L4	2153	0.23	860	0.02	71 ... 132	10100	10100	31000	34000	8000	2400
	300L4	2692	0.19	1000	0.02	71 ... 132	10400	10400	31000	34000	8000	2400

B

301 L



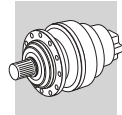

2460 Nm

n ₁ min ⁻¹		i	n ₂ min ⁻¹	M _{n2} Nm	P _{n1} kW	P (IEC) 	Rn ₂ [N]					M ₂ max Nm
							MC	MZ	HC/PC	HZ/PZ	FZ	
1500	301L1	3.48	431	840	30	71 ... 132	1850	1850	6950	7600	1060	3400
	301L1	4.26	352	880	30	71 ... 132	1980	1980	7390	8080	1130	3400
	301L1	5.77	260	930	26.1	71 ... 132	2190	2190	8090	8840	1250	3400
	301L1	7.20	208	750	17.0	71 ... 132	2360	2360	8650	9450	1350	3400
	301L1	9.00	167	630	11.3	71 ... 132	2540	2540	9240	10100	1450	3400
	301L2	12.1	124	1220	16.8	71 ... 132	2810	2810	10100	11000	1600	3400
	301L2	14.8	101	1280	14.4	71 ... 132	3010	3010	10700	11700	1720	3400
	301L2	18.2	83	1360	12.5	71 ... 132	3220	3220	11400	12500	1840	3400
	301L2	20.1	75	1260	10.5	71 ... 132	3320	3320	11800	12900	1900	3400
	301L2	24.6	61	1490	10.1	71 ... 132	3560	3560	12500	13700	2030	3400
	301L2	30.7	49	1580	8.6	71 ... 132	3830	3830	13400	14600	2190	3400
	301L2	33.3	45	1300	6.5	71 ... 132	3940	3940	13700	15000	2250	3400
	301L2	38.4	39	1540	6.7	71 ... 132	4130	4130	14300	15600	2360	3400
	301L2	41.5	36	1300	5.2	71 ... 132	4240	4240	14600	16000	2420	3400
	301L2	51.9	28.9	1300	4.2	71 ... 132	4560	4560	15600	17100	2610	3400
	301L2	64.8	23.1	1150	3.0	71 ... 132	4910	4910	16700	18300	2810	3400
	301L3	51.6	29.1	1630	5.4	71 ... 132	4560	4560	15600	17100	2600	3400
	301L3	63.2	23.7	1650	4.5	71 ... 132	4870	4870	16600	18100	2780	3400
	301L3	69.9	21.5	1300	3.2	71 ... 132	5040	5040	17100	18700	2880	3400
	301L3	77.5	19.4	1670	3.7	71 ... 132	5220	5220	17600	19300	2980	3400
	301L3	85.6	17.5	1680	3.4	71 ... 132	5390	5390	18200	19900	3080	3400
	301L3	105	14.3	1700	2.8	71 ... 132	5770	5770	19300	21100	3300	3400
	301L3	116	13.0	1300	1.9	71 ... 132	5960	5960	19900	21700	3410	3400
	301L3	131	11.5	1720	2.3	71 ... 132	6210	6210	20600	22600	3550	3400
	301L3	142	10.6	1720	2.1	71 ... 132	6380	6380	21100	23100	3650	3400
	301L3	177	8.5	1770	1.7	71 ... 132	6500	6500	21500	23500	3920	3400
	301L3	192	7.8	1300	1.2	71 ... 132	6500	6500	21500	23500	4030	3400
	301L3	221	6.8	1790	1.4	71 ... 132	6500	6500	21500	23500	4230	3400
	301L3	240	6.3	1300	0.93	71 ... 132	6500	6500	21500	23500	4340	3400
	301L3	299	5.0	1300	0.75	71 ... 132	6500	6500	21500	23500	4670	3400
	301L3	374	4.0	1350	0.62	71 ... 132	6710	6710	22200	24300	5030	3400



301 L 

2460 Nm

n ₁ min ⁻¹		i	n ₂ min ⁻¹	M _{n2} Nm	P _{n1} kW	P (IEC) 	Rn ₂ [N]					M _{2 max} Nm
							MC	MZ	HC/PC	HZ/PZ	FZ	
1500	301L4	330	4.5	1920	1.0	71 ... 132	6590	6590	21800	23800	4830	3400
	301L4	403	3.7	1370	0.60	71 ... 132	6780	6780	22400	24500	5160	3400
	301L4	447	3.4	2030	0.81	71 ... 132	6880	6880	22800	24900	5340	3400
	301L4	494	3.0	2070	0.74	71 ... 132	6980	6980	23100	25200	5520	3400
	301L4	558	2.7	2110	0.67	71 ... 132	7100	7100	23500	25700	5750	3400
	301L4	616	2.4	2150	0.62	71 ... 132	7200	7200	23800	26000	5950	3400
	301L4	755	2.0	2220	0.52	71 ... 132	7420	7420	24500	26800	6360	3400
	301L4	819	1.8	2240	0.49	71 ... 132	7500	7500	24800	27100	6540	3400
	301L4	942	1.6	2290	0.43	71 ... 132	7650	7650	25300	27700	6850	3400
	301L4	1022	1.5	2320	0.40	71 ... 132	7740	7740	25600	28000	7040	3400
	301L4	1108	1.4	1630	0.26	71 ... 132	7830	7830	25900	28300	7230	3400
	301L4	1275	1.2	2400	0.33	71 ... 132	7990	7990	26400	28900	7580	3400
	301L4	1383	1.1	1700	0.22	71 ... 132	8090	8090	26700	29200	7790	3400
	301L4	1591	0.94	2000	0.22	71 ... 132	8250	8250	27300	29800	8000	3400
	301L4	1725	0.87	1720	0.18	71 ... 132	8350	8350	27600	30200	8000	3400
	301L4	2153	0.70	1720	0.14	71 ... 132	8610	8610	28500	31100	8000	3400
	301L4	2692	0.56	1720	0.11	71 ... 132	8890	8890	29400	32200	8000	3400
	1000	301L1	3.48	287	950	29.4	71 ... 132	2120	2120	7850	8580	1210
301L1		4.26	235	990	25.1	71 ... 132	2270	2270	8340	9120	1300	3400
301L1		5.77	173	1050	19.7	71 ... 132	2510	2510	9140	9990	1430	3400
301L1		7.20	139	850	12.8	71 ... 132	2700	2700	9760	10700	1540	3400
301L1		9.00	111	710	8.5	71 ... 132	2910	2910	10400	11400	1660	3400
301L2		12.1	83	1330	12.3	71 ... 132	3220	3220	11400	12500	1840	3400
301L2		14.8	67	1440	10.8	71 ... 132	3440	3440	12100	13300	1970	3400
301L2		18.2	55	1530	9.4	71 ... 132	3680	3680	12900	14100	2100	3400
301L2		20.1	50	1300	7.2	71 ... 132	3810	3810	13300	14500	2170	3400
301L2		24.6	41	1600	7.2	71 ... 132	4070	4070	14100	15400	2330	3400
301L2		30.7	33	1620	5.9	71 ... 132	4380	4380	15100	16500	2500	3400
301L2		33.3	30	1300	4.3	71 ... 132	4500	4500	15500	16900	2570	3400
301L2		38.4	26.1	1550	4.5	71 ... 132	4720	4720	16100	17600	2700	3400
301L2		41.5	24.1	1300	3.5	71 ... 132	4850	4850	16500	18100	2770	3400
301L2		51.9	19.3	1300	2.8	71 ... 132	5220	5220	17700	19300	2980	3400
301L2		64.8	15.4	1150	2.0	71 ... 132	5620	5620	18900	20600	3210	3400
301L3		51.6	19.4	1670	3.7	71 ... 132	5210	5210	17600	19300	2980	3400
301L3		63.2	15.8	1690	3.1	71 ... 132	5580	5580	18700	20500	3190	3400
301L3		69.9	14.3	1300	2.1	71 ... 132	5770	5770	19300	21100	3290	3400
301L3		77.5	12.9	1710	2.5	71 ... 132	5970	5970	19900	21800	3410	3400
301L3		85.6	11.7	1710	2.3	71 ... 132	6170	6170	20500	22400	3530	3400
301L3		105	9.5	1740	1.9	71 ... 132	6500	6500	21500	23500	3770	3400
301L3		116	8.6	1300	1.3	71 ... 132	6500	6500	21500	23500	3900	3400
301L3		131	7.6	1790	1.6	71 ... 132	6500	6500	21500	23500	4060	3400
301L3		142	7.0	1810	1.5	71 ... 132	6500	6500	21500	23500	4170	3400
301L3		177	5.6	1860	1.2	71 ... 132	6500	6500	21500	23500	4490	3400
301L3		192	5.2	1300	0.78	71 ... 132	6500	6500	21500	23500	4620	3400
301L3		221	4.5	1850	0.96	71 ... 132	6590	6590	21800	23800	4840	3400
301L3		240	4.2	1340	0.64	71 ... 132	6670	6670	22100	24100	4970	3400
301L3		299	3.3	1390	0.53	71 ... 132	6880	6880	22800	24900	5350	3400
301L3		374	2.7	1440	0.44	71 ... 132	7110	7110	23500	25700	5760	3400
301L4		330	3.0	2070	0.74	71 ... 132	6980	6980	23100	25200	5530	3400
301L4		403	2.5	1460	0.43	71 ... 132	7180	7180	23800	26000	5910	3400
301L4		447	2.2	2180	0.58	71 ... 132	7290	7290	24100	26400	6120	3400
301L4		494	2.0	2210	0.53	71 ... 132	7400	7400	24500	26700	6320	3400
301L4		558	1.8	2250	0.48	71 ... 132	7530	7530	24900	27200	6590	3400
301L4		616	1.6	2290	0.44	71 ... 132	7630	7630	25200	27600	6810	3400
301L4		755	1.3	2360	0.37	71 ... 132	7860	7860	26000	28400	7280	3400
301L4		819	1.2	2390	0.34	71 ... 132	7950	7950	26300	28700	7480	3400
301L4		942	1.1	2440	0.31	71 ... 132	8110	8110	26800	29300	7840	3400
301L4		1022	0.98	2460	0.28	71 ... 132	8210	8210	27100	29700	8000	3400
301L4		1108	0.90	1720	0.18	71 ... 132	8300	8300	27500	30000	8000	3400
301L4		1275	0.78	2460	0.23	71 ... 132	8470	8470	28000	30600	8000	3400

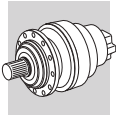

B



301 L



2460 Nm

n ₁ min ⁻¹		i	n ₂ min ⁻¹	M _{n2} Nm	P _{n1} kW	P (IEC) 	Rn ₂ [N]					M _{2 max} Nm
							MC	MZ	HC/PC	HZ/PZ	FZ	
1000	301L4	1383	0.72	1720	0.15	71 ... 132	8570	8570	28300	31000	8000	3400
	301L4	1591	0.63	2000	0.15	71 ... 132	8740	8740	28900	31600	8000	3400
	301L4	1725	0.58	1720	0.12	71 ... 132	8840	8840	29300	32000	8000	3400
	301L4	2153	0.46	1720	0.09	71 ... 132	9130	9130	30200	33000	8000	3400
	301L4	2692	0.37	1720	0.08	71 ... 132	9420	9420	31000	34000	8000	3400
500	301L1	3.48	144	1170	18.1	71 ... 132	2670	2670	9670	10600	1530	3400
	301L1	4.26	117	1220	15.4	71 ... 132	2860	2860	10300	11200	1630	3400
	301L1	5.77	87	1250	11.7	71 ... 132	3160	3160	11200	12300	1810	3400
	301L1	7.20	69	1050	7.8	71 ... 132	3410	3410	12000	13100	1950	3400
	301L1	9.00	56	730	4.4	71 ... 132	3670	3670	12900	14000	2100	3400
	301L2	12.1	41	1430	6.6	71 ... 132	4050	4050	14100	15400	2310	3400
	301L2	14.8	34	1620	6.1	71 ... 132	4340	4340	14900	16300	2480	3400
	301L2	18.2	27.5	1630	5.0	71 ... 132	4640	4640	15900	17300	2650	3400
	301L2	20.1	24.9	1300	3.6	71 ... 132	4800	4800	16400	17900	2740	3400
	301L2	24.6	20.3	1660	3.8	71 ... 132	5130	5130	17400	19000	2930	3400
	301L2	30.7	16.3	1680	3.1	71 ... 132	5520	5520	18600	20300	3160	3400
	301L2	33.3	15.0	1300	2.2	71 ... 132	5680	5680	19000	20800	3240	3400
	301L2	38.4	13.0	1560	2.3	71 ... 132	5950	5950	19900	21700	3400	3400
	301L2	41.5	12.0	1300	1.7	71 ... 132	6110	6110	20300	22200	3490	3400
	301L2	51.9	9.6	1300	1.4	71 ... 132	6500	6500	21500	23500	3760	3400
	301L2	64.8	7.7	1150	0.99	71 ... 132	6500	6500	21500	23500	4050	3400
	301L3	51.6	9.7	1740	1.9	71 ... 132	6500	6500	21500	23500	3750	3400
	301L3	63.2	7.9	1780	1.6	71 ... 132	6500	6500	21500	23500	4020	3400
	301L3	69.9	7.2	1300	1.1	71 ... 132	6500	6500	21500	23500	4150	3400
	301L3	77.5	6.5	1830	1.4	71 ... 132	6500	6500	21500	23500	4300	3400
	301L3	85.6	5.8	1850	1.2	71 ... 132	6500	6500	21500	23500	4440	3400
	301L3	105	4.8	1910	1.0	71 ... 132	6540	6540	21600	23700	4750	3400
	301L3	116	4.3	1330	0.66	71 ... 132	6640	6640	22000	24000	4910	3400
	301L3	131	3.8	1980	0.87	71 ... 132	6750	6750	22300	24400	5120	3400
	301L3	142	3.5	2010	0.81	71 ... 132	6830	6830	22600	24700	5260	3400
	301L3	177	2.8	2090	0.68	71 ... 132	7050	7050	23300	25500	5660	3400
	301L3	192	2.6	1450	0.43	71 ... 132	7130	7130	23600	25800	5820	3400
	301L3	221	2.3	2000	0.52	71 ... 132	7280	7280	24100	26300	6090	3400
	301L3	240	2.1	1510	0.36	71 ... 132	7360	7360	24400	26600	6260	3400
	301L3	299	1.7	1570	0.30	71 ... 132	7600	7600	25100	27500	6740	3400
	301L3	374	1.3	1630	0.25	71 ... 132	7850	7850	26000	28400	7260	3400
	301L4	330	1.5	2310	0.41	71 ... 132	7710	7710	25500	27900	6970	3400
	301L4	403	1.2	1650	0.24	71 ... 132	7930	7930	26200	28700	7450	3400
	301L4	447	1.1	2420	0.32	71 ... 132	8050	8050	26600	29100	7710	3400
	301L4	494	1.0	2460	0.29	71 ... 132	8170	8170	27000	29500	7970	3400
	301L4	558	0.90	2460	0.26	71 ... 132	8310	8310	27500	30000	8000	3400
	301L4	616	0.81	2460	0.24	71 ... 132	8430	8430	27900	30500	8000	3400
	301L4	755	0.66	2460	0.19	71 ... 132	8680	8680	28700	31400	8000	3400
	301L4	819	0.61	2460	0.18	71 ... 132	8780	8780	29000	31700	8000	3400
	301L4	942	0.53	2460	0.15	71 ... 132	8960	8960	29600	32400	8000	3400
	301L4	1022	0.49	2460	0.14	71 ... 132	9060	9060	30000	32800	8000	3400
	301L4	1108	0.45	1720	0.09	71 ... 132	9160	9160	30300	33100	8000	3400
	301L4	1275	0.39	2460	0.11	71 ... 132	9350	9350	30900	33800	8000	3400
	301L4	1383	0.36	1720	0.07	71 ... 132	9460	9460	31000	34000	8000	3400
	301L4	1591	0.31	2000	0.07	71 ... 132	9650	9650	31000	34000	8000	3400
301L4	1725	0.29	1720	0.06	71 ... 132	9760	9760	31000	34000	8000	3400	
301L4	2153	0.23	1720	0.05	71 ... 132	10100	10100	31000	34000	8000	3400	
301L4	2692	0.19	1720	0.04	71 ... 132	10400	10400	31000	34000	8000	3400	

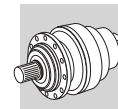

B



303 L



2970 Nm

n ₁ min ⁻¹		i	n ₂ min ⁻¹	M _{n2} Nm	P _{n1} kW	P (IEC) 	Rn ₂ [N]					M _{2 max} Nm
							MC	MZ	HC/PC	HZ/PZ	FZ	
1500	303L1	3.60	417	1380	40	132 ... 200	6060	6920	13200	15700	3210	5200
	303L1	4.25	353	1430	40	132 ... 200	6400	7320	13900	16500	3400	5200
	303L1	5.33	281	1490	40	132 ... 200	6910	7890	14900	17600	3660	5200
	303L1	6.20	242	1400	36	132 ... 200	7260	8300	15600	18500	3850	5200
	303L1	7.50	200	1220	26.3	132 ... 200	7740	8840	16500	19500	4100	5200
	303L1	9.67	155	750	12.6	132 ... 200	8420	9620	17800	21100	4470	5200
	303L2	12.5	120	1640	20.0	71 ... 160	9180	10500	19200	22800	4870	5200
	303L2	15.3	98	1710	18.6	71 ... 160	9820	11200	20400	24200	5210	5200
	303L2	18.1	83	2020	18.6	71 ... 160	10400	11900	21500	25500	5510	5200
	303L2	20.8	72	1820	14.6	71 ... 160	10900	12400	22400	26500	5760	5200
	303L2	22.7	66	2100	15.4	71 ... 160	11200	12800	23000	27300	5940	5200
	303L2	24.5	61	2150	14.6	71 ... 160	11500	13100	23500	27900	6090	5200
	303L2	26.4	57	1820	11.5	71 ... 160	11800	13500	24100	28500	6250	5200
	303L2	30.8	49	2140	11.6	71 ... 160	12400	14200	25200	29800	6570	5200
	303L2	35.8	42	1820	8.5	71 ... 160	13000	14900	26300	31200	6910	5200
	303L2	38.4	39	2150	9.3	71 ... 160	13300	15200	26900	31900	7070	5200
	303L2	44.6	34	1820	6.8	71 ... 160	14000	16000	28200	33400	7440	5200
	303L2	55.8	26.9	1820	5.4	71 ... 160	15100	17300	30100	35700	8010	5200
	303L3	53.4	28.1	2170	7.0	71 ... 160	14900	17000	29700	35200	7900	5200
	303L3	63.1	23.8	2510	6.8	71 ... 160	15700	18000	31200	37000	8340	5200
	303L3	72.3	20.8	2230	5.3	71 ... 160	16500	18800	32500	38600	8730	5200
	303L3	77.2	19.4	2520	5.6	71 ... 160	16800	19200	33200	39300	8930	5200
	303L3	90.2	16.6	2250	4.3	71 ... 160	17700	20300	34800	41200	9400	5200
	303L3	105	14.4	2580	4.2	71 ... 160	18600	21300	36300	43100	9880	5200
	303L3	113	13.3	1820	2.8	71 ... 160	19100	21800	37200	44100	10100	5200
	303L3	124	12.1	1820	2.5	71 ... 160	19700	22600	38300	45400	10500	5200
	303L3	141	10.6	2610	3.2	71 ... 160	20600	23500	39800	47200	10900	5200
	303L3	152	9.8	1820	2.1	71 ... 160	21000	24000	40500	48000	11200	5200
	303L3	164	9.2	2200	2.3	71 ... 160	21000	24000	40500	48000	11500	5200
	303L3	178	8.5	2210	2.1	71 ... 160	21000	24000	40500	48000	11800	5200
	303L3	190	7.9	1830	1.7	71 ... 160	21000	24000	40500	48000	12100	5200
	303L3	220	6.8	2250	1.8	71 ... 160	21000	24000	40500	48000	12700	5200
	303L3	258	5.8	1840	1.2	71 ... 160	21000	24000	40500	48000	13300	5200
	303L3	276	5.4	2230	1.4	71 ... 160	21000	24000	40500	48000	13700	5200
	303L3	321	4.7	1860	1.0	71 ... 160	21200	24200	40900	48500	14400	5200
	303L3	389	3.9	1690	0.75	71 ... 160	21800	24900	42000	49800	15300	5200
	303L3	402	3.7	1940	0.83	71 ... 160	21900	25000	42200	50000	15500	5200
	303L4	413	3.6	2360	1.0	71 ... 160	22000	25100	42400	50200	15600	5200
	303L4	446	3.4	2810	1.1	71 ... 160	22200	25400	42900	50800	16000	5200
	303L4	492	3	2690	0.97	71 ... 160	22500	25800	43500	51500	16600	5200
	303L4	556	2.7	2810	0.90	71 ... 160	22900	26200	44200	52400	17200	5200
	303L4	649	2.3	2320	0.63	71 ... 160	23400	26800	45200	53600	18200	5200
	303L4	718	2.1	2150	0.53	71 ... 160	23800	27200	45900	54400	18800	5200
	303L4	816	1.8	2720	0.59	71 ... 160	24200	27700	46700	55400	19600	5200
303L4	896	1.7	2230	0.44	71 ... 160	24600	28100	47400	56100	20200	5200	
303L4	1018	1.5	2740	0.48	71 ... 160	25000	28600	48200	57200	21100	5200	
303L4	1098	1.4	2310	0.37	71 ... 160	25300	28900	48700	57800	21600	5200	
303L4	1278	1.2	2790	0.39	71 ... 160	25800	29500	49800	59000	22800	5200	
303L4	1370	1.1	2400	0.31	71 ... 160	26100	29800	50300	59600	23300	5200	
303L4	1586	0.95	2250	0.25	71 ... 160	26600	30400	51400	60900	24000	5200	
303L4	1854	0.81	2440	0.23	71 ... 160	27200	31100	52500	62300	24000	5200	
303L4	1991	0.75	2850	0.25	71 ... 160	27500	31500	53100	62900	24000	5200	
303L4	2243	0.67	2000	0.16	71 ... 160	28000	32000	54000	64000	24000	5200	
303L4	2799	0.54	2000	0.13	71 ... 160	28900	33000	55700	66000	24000	5200	
1000	303L1	3.60	278	1560	40	132 ... 200	6930	7920	14900	17700	3680	5200
	303L1	4.25	235	1620	40	132 ... 200	7330	8380	15700	18600	3890	5200
	303L1	5.33	188	1680	34	132 ... 200	7900	9030	16800	19900	4190	5200
	303L1	6.20	161	1580	27.5	132 ... 200	8310	9500	17600	20800	4410	5200
	303L1	7.50	133	1380	19.8	132 ... 200	8860	10100	18600	22100	4700	5200
	303L1	9.67	103	850	9.5	132 ... 200	9640	11000	20100	23800	5110	5200

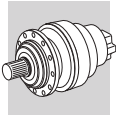

B



303 L



2970 Nm

n ₁ min ⁻¹		i	n ₂ min ⁻¹	M _{n2} Nm	P _{n1} kW	P (IEC) 	Rn ₂ [N]					M ₂ max Nm
							MC	MZ	HC/PC	HZ/PZ	FZ	
1000	303L2	12.5	80	1850	16.4	71 ... 160	10500	12000	21700	25700	5570	5200
	303L2	15.3	65	1940	14.0	71 ... 160	11200	12800	23100	27400	5960	5200
	303L2	18.1	55	2280	14.0	71 ... 160	11900	13600	24300	28800	6300	5200
	303L2	20.8	48	2030	10.9	71 ... 160	12400	14200	25300	30000	6600	5200
	303L2	22.7	44	2140	10.5	71 ... 160	12800	14600	26000	30800	6800	5200
	303L2	24.5	41	2320	10.5	71 ... 160	13100	15000	26600	31500	6970	5200
	303L2	26.4	38	1820	7.7	71 ... 160	13500	15400	27200	32200	7150	5200
	303L2	30.8	33	2160	7.8	71 ... 160	14200	16200	28400	33700	7520	5200
	303L2	35.8	28.0	1820	5.7	71 ... 160	14900	17000	29800	35300	7910	5200
	303L2	38.4	26.0	2160	6.3	71 ... 160	15300	17400	30400	36000	8100	5200
	303L2	44.6	22.4	1820	4.5	71 ... 160	16000	18300	31800	37700	8510	5200
	303L2	55.8	17.9	1820	3.6	71 ... 160	17300	19800	34000	40300	9170	5200
	303L3	53.4	18.7	2230	4.8	71 ... 160	17000	19500	33600	39800	9040	5200
	303L3	63.1	15.9	2570	4.7	71 ... 160	18000	20600	35300	41800	9550	5200
	303L3	72.3	13.8	2270	3.6	71 ... 160	18800	21500	36700	43500	10000	5200
	303L3	77.2	12.9	2600	3.9	71 ... 160	19300	22000	37500	44400	10200	5200
	303L3	90.2	11.1	2300	2.9	71 ... 160	20300	23200	39300	46500	10800	5200
	303L3	105	9.6	2660	2.9	71 ... 160	21000	24000	40500	48000	11300	5200
	303L3	113	8.9	1820	1.9	71 ... 160	21000	24000	40500	48000	11600	5200
	303L3	124	8.0	1830	1.7	71 ... 160	21000	24000	40500	48000	12000	5200
	303L3	141	7.1	2630	2.1	71 ... 160	21000	24000	40500	48000	12500	5200
	303L3	152	6.6	1830	1.4	71 ... 160	21000	24000	40500	48000	12800	5200
	303L3	164	6.1	2220	1.6	71 ... 160	21000	24000	40500	48000	13100	5200
	303L3	178	5.6	2220	1.4	71 ... 160	21000	24000	40500	48000	13500	5200
	303L3	190	5.3	1840	1.1	71 ... 160	21000	24000	40500	48000	13800	5200
	303L3	220	4.5	2240	1.2	71 ... 160	21300	24300	41100	48700	14500	5200
	303L3	258	3.9	1920	0.86	71 ... 160	21800	24900	42000	49800	15300	5200
	303L3	276	3.6	2330	0.97	71 ... 160	22000	25100	42400	50300	15600	5200
	303L3	321	3.1	2000	0.71	71 ... 160	22500	25700	43300	51400	16400	5200
	303L3	389	2.6	1750	0.52	71 ... 160	23100	26400	44500	52800	17500	5200
	303L3	402	2.5	2080	0.59	71 ... 160	23200	26500	44700	53000	17700	5200
	303L4	413	2.4	2530	0.72	71 ... 160	23300	26600	44900	53200	17900	5200
	303L4	446	2.2	2830	0.75	71 ... 160	23500	26900	45400	53800	18300	5200
	303L4	492	2.0	2720	0.65	71 ... 160	23900	27300	46100	54600	19000	5200
	303L4	556	1.8	2870	0.61	71 ... 160	24300	27800	46900	55600	19700	5200
	303L4	649	1.5	2360	0.43	71 ... 160	24800	28400	47900	56800	20800	5200
	303L4	718	1.4	2300	0.38	71 ... 160	25200	28800	48600	57600	21500	5200
	303L4	816	1.2	2750	0.40	71 ... 160	25700	29300	49500	58700	22400	5200
	303L4	896	1.1	2390	0.32	71 ... 160	26000	29700	50200	59500	23100	5200
	303L4	1018	0.98	2770	0.32	71 ... 160	26500	30300	51100	60600	24000	5200
	303L4	1098	0.91	2440	0.26	71 ... 160	26800	30600	51700	61200	24000	5200
	303L4	1278	0.78	2850	0.26	71 ... 160	27400	31300	52800	62600	24000	5200
	303L4	1370	0.73	2440	0.21	71 ... 160	27600	31600	53300	63200	24000	5200
	303L4	1586	0.63	2250	0.17	71 ... 160	28200	32300	54400	64500	24000	5200
	303L4	1854	0.54	2440	0.16	71 ... 160	28900	33000	55700	66000	24000	5200
303L4	1991	0.50	2850	0.17	71 ... 160	29200	33300	56200	66700	24000	5200	
303L4	2243	0.45	2000	0.11	71 ... 160	29700	33900	57200	67800	24000	5200	
303L4	2799	0.36	2000	0.08	71 ... 160	30600	35000	59000	70000	24000	5200	
500	303L1	3.60	139	1920	28.8	132 ... 200	8740	9980	18400	21800	4630	5200
	303L1	4.25	118	1990	25.3	132 ... 200	9230	10600	19300	22900	4900	5200
	303L1	5.33	94	2040	20.6	132 ... 200	9960	11400	20700	24500	5280	5200
	303L1	6.20	81	1820	15.8	132 ... 200	10500	12000	21700	25700	5560	5200
	303L1	7.50	67	1590	11.4	132 ... 200	11200	12800	22900	27200	5920	5200
	303L1	9.67	52	860	4.8	132 ... 200	12100	13900	24700	29300	6440	5200
	303L2	12.5	40	2150	9.6	71 ... 160	13200	15100	26700	31700	7020	5200
	303L2	15.3	33	2150	7.8	71 ... 160	14200	16200	28400	33700	7510	5200
	303L2	18.1	27.6	2460	7.5	71 ... 160	15000	17100	29900	35400	7940	5200
	303L2	20.8	24.1	2110	5.7	71 ... 160	15700	17900	31100	36900	8310	5200
	303L2	22.7	22.0	2170	5.3	71 ... 160	16100	18500	32000	37900	8570	5200
	303L2	24.5	20.4	2460	5.6	71 ... 160	16600	18900	32700	38800	8780	5200
	303L2	26.4	18.9	1820	3.8	71 ... 160	17000	19400	33500	39600	9010	5200

B

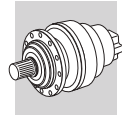

303 L

2970 Nm

n ₁ min ⁻¹		i	n ₂ min ⁻¹	M _{n2} Nm	P _{n1} kW	P (IEC)	Rn ₂ [N]					M _{2 max} Nm
							MC	MZ	HC/PC	HZ/PZ	FZ	
500	303L2	30.8	16.3	2180	3.9	71 ... 160	17900	20400	35000	41500	9480	5200
	303L2	35.8	14.0	1820	2.8	71 ... 160	18800	21500	36600	43400	9960	5200
	303L2	38.4	13.0	2190	3.2	71 ... 160	19200	22000	37400	44300	10200	5200
	303L2	44.6	11.2	1820	2.3	71 ... 160	20200	23100	39100	46400	10700	5200
	303L2	55.8	9.0	1820	1.8	71 ... 160	21000	24000	40500	48000	11600	5200
	303L3	53.4	9.4	2310	2.5	71 ... 160	21000	24000	40500	48000	11400	5200
	303L3	63.1	7.9	2700	2.5	71 ... 160	21000	24000	40500	48000	12000	5200
	303L3	72.3	6.9	2310	1.8	71 ... 160	21000	24000	40500	48000	12600	5200
	303L3	77.2	6.5	2750	2.0	71 ... 160	21000	24000	40500	48000	12900	5200
	303L3	90.2	5.5	2310	1.5	71 ... 160	21000	24000	40500	48000	13600	5200
	303L3	105	4.8	2810	1.5	71 ... 160	21100	24200	40800	48300	14200	5200
	303L3	113	4.4	1880	0.96	71 ... 160	21400	24400	41200	48800	14600	5200
	303L3	124	4.0	1910	0.88	71 ... 160	21700	24800	41800	49500	15100	5200
	303L3	141	3.5	2670	1.1	71 ... 160	22100	25200	42600	50400	15800	5200
	303L3	152	3.3	1980	0.75	71 ... 160	22300	25500	43000	51000	16200	5200
	303L3	164	3.1	2430	0.85	71 ... 160	22500	25800	43500	51500	16500	5200
	303L3	178	2.8	2470	0.80	71 ... 160	22800	26100	44000	52100	17000	5200
	303L3	190	2.6	2060	0.62	71 ... 160	23000	26300	44400	52600	17400	5200
	303L3	220	2.3	2210	0.57	71 ... 160	23500	26900	45300	53700	18300	5200
	303L3	258	1.9	2170	0.48	71 ... 160	24000	27500	46400	54900	19200	5200
	303L3	276	1.8	2580	0.54	71 ... 160	24300	27800	46800	55500	19700	5200
	303L3	321	1.6	2260	0.40	71 ... 160	24800	28400	47900	56700	20700	5200
	303L3	389	1.3	1930	0.28	71 ... 160	25500	29100	49200	58300	22100	5200
	303L3	402	1.2	2350	0.34	71 ... 160	25600	29300	49400	58500	22300	5200
	303L4	413	1.2	2780	0.40	71 ... 160	25700	29400	49600	58800	22500	5200
	303L4	446	1.1	2950	0.39	71 ... 160	26000	29700	50100	59400	23100	5200
	303L4	492	1.0	2770	0.33	71 ... 160	26400	30100	50900	60300	23900	5200
	303L4	556	0.90	2970	0.32	71 ... 160	26800	30700	51700	61300	24000	5200
	303L4	649	0.77	2410	0.22	71 ... 160	27400	31400	52900	62700	24000	5200
	303L4	718	0.70	2440	0.20	71 ... 160	27800	31800	53700	63600	24000	5200
	303L4	816	0.61	2770	0.20	71 ... 160	28300	32400	54700	64800	24000	5200
	303L4	896	0.56	2440	0.16	71 ... 160	28700	32800	55400	65700	24000	5200
	303L4	1018	0.49	2770	0.16	71 ... 160	29300	33400	56400	66900	24000	5200
	303L4	1098	0.46	2440	0.13	71 ... 160	29600	33800	57000	67600	24000	5200
	303L4	1278	0.39	2850	0.13	71 ... 160	30200	34500	58300	69100	24000	5200
	303L4	1370	0.36	2440	0.11	71 ... 160	30500	34900	58900	69800	24000	5200
	303L4	1586	0.32	2250	0.08	71 ... 160	31200	35600	60100	71200	24000	5200
	303L4	1854	0.27	2440	0.08	71 ... 160	31900	36400	61500	72800	24000	5200
	303L4	1991	0.25	2850	0.08	71 ... 160	32200	36800	62100	73600	24000	5200
	303L4	2243	0.22	2000	0.05	71 ... 160	32700	37400	63200	74000	24000	5200
303L4	2799	0.18	2000	0.04	71 ... 160	33800	38600	64000	74000	24000	5200	

304 L

3960 Nm

n ₁ min ⁻¹		i	n ₂ min ⁻¹	M _{n2} Nm	P _{n1} kW	P (IEC)	Rn ₂ [N]					M _{2 max} Nm
							MC	MZ	HC/PC	HZ/PZ	FZ	
1500	304L1	3.60	417	1840	50	132 ... 200	6060	6920	13200	15700	3210	7300
	304L1	4.25	353	1900	50	132 ... 200	6400	7320	13900	16500	3400	7300
	304L1	5.33	281	1990	50	132 ... 200	6910	7890	14900	17600	3660	7300
	304L1	6.57	228	1870	46	132 ... 200	7400	8460	15800	18800	3930	7300
	304L2	12.5	120	2680	30	71 ... 160	9180	10500	19200	22800	4870	7300
	304L2	15.3	98	2840	30	71 ... 160	9820	11200	20400	24200	5210	7300
	304L2	18.1	83	2940	27.1	71 ... 160	10400	11900	21500	25500	5510	7300
	304L2	20.8	72	2960	23.8	71 ... 160	10900	12400	22400	26500	5760	7300
	304L2	22.7	66	2790	20.5	71 ... 160	11200	12800	23000	27300	5940	7300
	304L2	24.5	61	3230	22.0	71 ... 160	11500	13100	23500	27900	6090	7300
	304L2	30.8	49	2850	15.5	71 ... 160	12400	14200	25200	29800	6570	7300
	304L2	38.4	39	2850	12.4	71 ... 160	13300	15200	26900	31900	7070	7300
	304L2	47.3	32	2390	8.4	71 ... 160	14300	16300	28700	34000	7580	7300

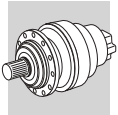

B



304 L



3960 Nm

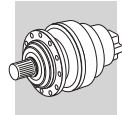

n ₁ min ⁻¹		i	n ₂ min ⁻¹	M _{n2} Nm	P _{n1} kW	P (IEC) 	Rn ₂ [N]					M _{2 max} Nm
							MC	MZ	HC/PC	HZ/PZ	FZ	
1500	304L2	59.1	25.4	2390	6.7	71 ... 160	15400	17600	30600	36300	8170	7300
	304L3	43.6	34	3190	12.6	71 ... 160	13900	15900	28000	33100	7380	7300
	304L3	53.4	28.1	3230	10.4	71 ... 160	14900	17000	29700	35200	7900	7300
	304L3	63.1	23.8	3480	9.5	71 ... 160	15700	18000	31200	37000	8340	7300
	304L3	72.3	20.8	3290	7.8	71 ... 160	16500	18800	32500	38600	8730	7300
	304L3	77.2	19.4	3490	7.8	71 ... 160	16800	19200	33200	39300	8930	7300
	304L3	90.2	16.6	3320	6.3	71 ... 160	17700	20300	34800	41200	9400	7300
	304L3	105	14.4	3520	5.8	71 ... 160	18600	21300	36300	43100	9880	7300
	304L3	111	13.6	3380	5.3	71 ... 160	19000	21700	37000	43800	10100	7300
	304L3	130	11.5	3530	4.7	71 ... 160	20000	22900	38800	46000	10600	7300
	304L3	141	10.6	3540	4.3	71 ... 160	20600	23500	39800	47200	10900	7300
	304L3	150	10.0	3440	4.0	71 ... 160	21000	24000	40500	48000	11100	7300
	304L3	165	9.1	2390	2.5	71 ... 160	21000	24000	40500	48000	11500	7300
	304L3	178	8.5	2850	2.8	71 ... 160	21000	24000	40500	48000	11800	7300
	304L3	202	7.4	2390	2.0	71 ... 160	21000	24000	40500	48000	12300	7300
	304L3	220	6.8	3610	2.8	71 ... 160	21000	24000	40500	48000	12700	7300
	304L3	273	5.5	2390	1.5	71 ... 160	21000	24000	40500	48000	13600	7300
	304L3	341	4.4	2420	1.2	71 ... 160	21400	24400	41300	48900	14700	7300
	304L3	426	3.5	2470	1.0	71 ... 160	22100	25200	42600	50500	15800	7300
	304L4	413	3.6	3000	1.3	71 ... 160	22000	25100	42400	50200	15600	7300
	304L4	446	3.4	3720	1.5	71 ... 160	22200	25400	42900	50800	16000	7300
	304L4	492	3.0	3730	1.3	71 ... 160	22500	25800	43500	51500	16600	7300
	304L4	556	2.7	3740	1.2	71 ... 160	22900	26200	44200	52400	17200	7300
	304L4	649	2.3	3540	0.97	71 ... 160	23400	26800	45200	53600	18200	7300
	304L4	702	2.1	2630	0.66	71 ... 160	23700	27100	45700	54200	18600	7300
	304L4	816	1.8	3820	0.83	71 ... 160	24200	27700	46700	55400	19600	7300
	304L4	1018	1.5	3870	0.67	71 ... 160	25000	28600	48200	57200	21100	7300
	304L4	1164	1.3	2870	0.44	71 ... 160	25500	29100	49200	58300	22100	7300
	304L4	1271	1.2	3920	0.55	71 ... 160	25800	29500	49800	59000	22700	7300
	304L4	1344	1.1	3690	0.49	71 ... 160	26000	29700	50200	59500	23100	7300
	304L4	1586	0.95	3960	0.44	71 ... 160	26600	30400	51400	60900	24000	7300
	304L4	1815	0.83	3000	0.29	71 ... 160	27200	31000	52400	62100	24000	7300
	304L4	1991	0.75	3740	0.33	71 ... 160	27500	31500	53100	62900	24000	7300
	304L4	2269	0.66	3000	0.23	71 ... 160	28000	32000	54100	64100	24000	7300
	304L4	2453	0.61	3000	0.22	71 ... 160	28400	32400	54700	64800	24000	7300
	1000	304L1	3.60	278	2080	50	132 ... 200	6930	7920	14900	17700	3680
304L1		4.25	235	2150	50	132 ... 200	7330	8380	15700	18600	3890	7300
304L1		5.33	188	2240	45	132 ... 200	7900	9030	16800	19900	4190	7300
304L1		6.57	152	2110	35	132 ... 200	8470	9680	17900	21200	4500	7300
304L2		12.5	80	2920	25.9	71 ... 160	10500	12000	21700	25700	5570	7300
304L2		15.3	65	3010	21.8	71 ... 160	11200	12800	23100	27400	5960	7300
304L2		18.1	55	3330	20.4	71 ... 160	11900	13600	24300	28800	6300	7300
304L2		20.8	48	3130	16.8	71 ... 160	12400	14200	25300	30000	6600	7300
304L2		22.7	44	2850	13.9	71 ... 160	12800	14600	26000	30800	6800	7300
304L2		24.5	41	3440	15.6	71 ... 160	13100	15000	26600	31500	6970	7300
304L2		30.8	33	2850	10.3	71 ... 160	14200	16200	28400	33700	7520	7300
304L2		38.4	26.0	2850	8.3	71 ... 160	15300	17400	30400	36000	8100	7300
304L2		47.3	21.1	2390	5.6	71 ... 160	16400	18700	32400	38300	8680	7300
304L2		59.1	16.9	2390	4.5	71 ... 160	17600	20100	34600	41000	9350	7300
304L3		43.6	22.9	3270	8.6	71 ... 160	15900	18200	31600	37400	8450	7300
304L3		53.4	18.7	3310	7.1	71 ... 160	17000	19500	33600	39800	9040	7300
304L3		63.1	15.9	3510	6.4	71 ... 160	18000	20600	35300	41800	9550	7300
304L3		72.3	13.8	3370	5.4	71 ... 160	18800	21500	36700	43500	10000	7300
304L3		77.2	12.9	3520	5.2	71 ... 160	19300	22000	37500	44400	10200	7300
304L3		90.2	11.1	3420	4.3	71 ... 160	20300	23200	39300	46500	10800	7300
304L3		105	9.6	3550	3.9	71 ... 160	21000	24000	40500	48000	11300	7300
304L3		111	9.0	3450	3.6	71 ... 160	21000	24000	40500	48000	11500	7300
304L3		130	7.7	3600	3.2	71 ... 160	21000	24000	40500	48000	12200	7300
304L3		141	7.1	3610	2.9	71 ... 160	21000	24000	40500	48000	12500	7300
304L3		150	6.7	3470	2.7	71 ... 160	21000	24000	40500	48000	12700	7300



304 L



3960 Nm

n ₁ min ⁻¹		i	n ₂ min ⁻¹	M _{n2} Nm	P _{n1} kW	P (IEC) 	Rn ₂ [N]					M _{2 max} Nm	
							MC	MZ	HC/PC	HZ/PZ	FZ		
1000	304L3	165	6.1	2390	1.7	71 ... 160	21000	24000	40500	48000	13200	7300	
	304L3	178	5.6	2850	1.8	71 ... 160	21000	24000	40500	48000	13500	7300	
	304L3	202	5.0	2390	1.4	71 ... 160	21000	24000	40500	48100	14100	7300	
	304L3	220	4.5	3670	1.9	71 ... 160	21300	24300	41100	48700	14500	7300	
	304L3	273	3.7	2460	1.0	71 ... 160	22000	25100	42300	50200	15600	7300	
	304L3	341	2.9	2520	0.85	71 ... 160	22700	25900	43700	51800	16800	7300	
	304L3	426	2.3	2590	0.70	71 ... 160	23400	26700	45100	53500	18100	7300	
	304L4	413	2.4	3210	0.92	71 ... 160	23300	26600	44900	53200	17900	7300	
	304L4	446	2.2	3770	1.0	71 ... 160	23500	26900	45400	53800	18300	7300	
	304L4	492	2.0	3800	0.91	71 ... 160	23900	27300	46100	54600	19000	7300	
	304L4	556	1.8	3820	0.81	71 ... 160	24300	27800	46900	55600	19700	7300	
	304L4	649	1.5	3620	0.66	71 ... 160	24800	28400	47900	56800	20800	7300	
	304L4	702	1.4	2820	0.48	71 ... 160	25100	28700	48500	57400	21300	7300	
	304L4	816	1.2	3910	0.57	71 ... 160	25700	29300	49500	58700	22400	7300	
	304L4	1018	0.98	3960	0.46	71 ... 160	26500	30300	51100	60600	24000	7300	
	304L4	1164	0.86	3000	0.30	71 ... 160	27000	30900	52100	61700	24000	7300	
	304L4	1271	0.79	3960	0.37	71 ... 160	27300	31300	52700	62500	24000	7300	
	304L4	1344	0.74	3710	0.33	71 ... 160	27600	31500	53200	63000	24000	7300	
	304L4	1586	0.63	3960	0.30	71 ... 160	28200	32300	54400	64500	24000	7300	
	304L4	1815	0.55	3000	0.20	71 ... 160	28800	32900	55500	65800	24000	7300	
	304L4	1991	0.50	3740	0.22	71 ... 160	29200	33300	56200	66700	24000	7300	
	304L4	2269	0.44	3000	0.16	71 ... 160	29700	34000	57300	67900	24000	7300	
	304L4	2453	0.41	3000	0.14	71 ... 160	30000	34300	57900	68700	24000	7300	
	500	304L1	3.60	139	2560	38	132 ... 200	8740	9980	18400	21800	4630	7300
		304L1	4.25	118	2650	34	132 ... 200	9230	10600	19300	22900	4900	7300
		304L1	5.33	94	2720	27.6	132 ... 200	9960	11400	20700	24500	5280	7300
		304L1	6.57	76	2390	19.6	132 ... 200	10700	12200	22000	26100	5660	7300
		304L2	12.5	40	3160	14.0	71 ... 160	13200	15100	26700	31700	7020	7300
		304L2	15.3	33	3200	11.6	71 ... 160	14200	16200	28400	33700	7510	7300
		304L2	18.1	27.6	3470	10.7	71 ... 160	15000	17100	29900	35400	7940	7300
		304L2	20.8	24.1	3260	8.7	71 ... 160	15700	17900	31100	36900	8310	7300
		304L2	22.7	22.0	2850	7.0	71 ... 160	16100	18500	32000	37900	8570	7300
304L2		24.5	20.4	3490	7.9	71 ... 160	16600	18900	32700	38800	8780	7300	
304L2		30.8	16.3	2850	5.2	71 ... 160	17900	20400	35000	41500	9480	7300	
304L2		38.4	13.0	2850	4.1	71 ... 160	19200	22000	37400	44300	10200	7300	
304L2		47.3	10.6	2390	2.8	71 ... 160	20600	23600	39800	47200	10900	7300	
304L2		59.1	8.5	2390	2.2	71 ... 160	21000	24000	40500	48000	11800	7300	
304L3		43.6	11.5	3410	4.5	71 ... 160	20100	22900	38900	46100	10600	7300	
304L3		53.4	9.4	3450	3.7	71 ... 160	21000	24000	40500	48000	11400	7300	
304L3		63.1	7.9	3590	3.3	71 ... 160	21000	24000	40500	48000	12000	7300	
304L3		72.3	6.9	3470	2.8	71 ... 160	21000	24000	40500	48000	12600	7300	
304L3		77.2	6.5	3630	2.7	71 ... 160	21000	24000	40500	48000	12900	7300	
304L3		90.2	5.5	3490	2.2	71 ... 160	21000	24000	40500	48000	13600	7300	
304L3		105	4.8	3690	2.0	71 ... 160	21100	24200	40800	48300	14200	7300	
304L3		111	4.5	3500	1.8	71 ... 160	21300	24300	41100	48700	14500	7300	
304L3		130	3.8	3710	1.6	71 ... 160	21800	24900	42100	49900	15300	7300	
304L3		141	3.5	3720	1.5	71 ... 160	22100	25200	42600	50400	15800	7300	
304L3		150	3.3	3510	1.3	71 ... 160	22200	25400	42900	50800	16000	7300	
304L3		165	3.0	2510	0.87	71 ... 160	22600	25800	43500	51500	16600	7300	
304L3		178	2.8	3130	1.0	71 ... 160	22800	26100	44000	52100	17000	7300	
304L3		202	2.5	2560	0.73	71 ... 160	23200	26500	44800	53100	17700	7300	
304L3		220	2.3	3740	0.97	71 ... 160	23500	26900	45300	53700	18300	7300	
304L3		273	1.8	2700	0.57	71 ... 160	24200	27700	46700	55400	19600	7300	
304L3		341	1.5	2810	0.47	71 ... 160	25000	28600	48300	57200	21100	7300	
304L3		426	1.2	2920	0.39	71 ... 160	25800	29500	49800	59000	22700	7300	
304L4		413	1.2	3620	0.52	71 ... 160	25700	29400	49600	58800	22500	7300	
304L4		446	1.1	3930	0.52	71 ... 160	26000	29700	50100	59400	23100	7300	
304L4		492	1.0	3960	0.48	71 ... 160	26400	30100	50900	60300	23900	7300	
304L4		556	0.90	3960	0.42	71 ... 160	26800	30700	51700	61300	24000	7300	
304L4		649	0.77	3710	0.34	71 ... 160	27400	31400	52900	62700	24000	7300	

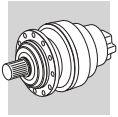

B



304 L





3960 Nm

n ₁ min ⁻¹		i	n ₂ min ⁻¹	M _{n2} Nm	P _{n1} kW	P (IEC) 	Rn ₂ [N]					M _{2 max} Nm
							MC	MZ	HC/PC	HZ/PZ	FZ	
500	304L4	702	0.71	3000	0.25	71 ... 160	27700	31700	53500	63400	24000	7300
	304L4	816	0.61	3960	0.29	71 ... 160	28300	32400	54700	64800	24000	7300
	304L4	1018	0.49	3960	0.23	71 ... 160	29300	33400	56400	66900	24000	7300
	304L4	1164	0.43	3000	0.15	71 ... 160	29800	34100	57500	68200	24000	7300
	304L4	1271	0.39	3960	0.18	71 ... 160	30200	34500	58200	69000	24000	7300
	304L4	1344	0.37	3710	0.16	71 ... 160	30400	34800	58700	69600	24000	7300
	304L4	1586	0.32	3960	0.15	71 ... 160	31200	35600	60100	71200	24000	7300
	304L4	1815	0.28	3000	0.10	71 ... 160	31800	36300	61300	72600	24000	7300
	304L4	1991	0.25	3740	0.11	71 ... 160	32200	36800	62100	73600	24000	7300
	304L4	2269	0.22	3000	0.08	71 ... 160	32800	37500	63300	74000	24000	7300
	304L4	2453	0.20	3000	0.07	71 ... 160	33200	37900	64000	74000	24000	7300

305 L



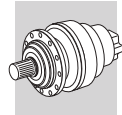

5800 Nm

n ₁ min ⁻¹		i	n ₂ min ⁻¹	M _{n2} Nm	P _{n1} kW	P (IEC) 	Rn ₂ [N]					M _{2 max} Nm
							MC	MZ	HC/PC	HZ/PZ	FZ	
1500	305L1	3.60	417	2370	60	132 ... 200	6060	6920	13200	15700	3210	8800
	305L1	4.25	353	2450	60	132 ... 200	6400	7320	13900	16500	3400	8800
	305L1	5.33	281	2560	60	132 ... 200	6910	7890	14900	17600	3660	8800
	305L1	6.20	242	2650	60	132 ... 200	7260	8300	15600	18500	3850	8800
	305L1	7.50	200	2270	49	132 ... 200	7740	8840	16500	19500	4100	8800
	305L2	12.5	120	2930	30	71 ... 160	9180	10500	19200	22800	4870	8800
	305L2	15.3	98	3060	30	71 ... 160	9820	11200	20400	24200	5210	8800
	305L2	18.1	83	3620	30	71 ... 160	10400	11900	21500	25500	5510	8800
	305L2	20.8	72	3250	26.1	71 ... 160	10900	12400	22400	26500	5760	8800
	305L2	22.7	66	3940	29.0	71 ... 160	11200	12800	23000	27300	5940	8800
	305L2	24.5	61	3830	26.1	71 ... 160	11500	13100	23500	27900	6090	8800
305L2	26.4	57	3530	22.3	71 ... 160	11800	13500	24100	28500	6250	8800	
305L2	30.8	49	4280	23.2	71 ... 160	12400	14200	25200	29800	6570	8800	
305L2	35.8	42	3560	16.6	71 ... 160	13000	14900	26300	31200	6910	8800	
305L2	38.4	39	4300	18.7	71 ... 160	13300	15200	26900	31900	7070	8800	
305L2	44.6	34	3560	13.3	71 ... 160	14000	16000	28200	33400	7440	8800	
305L2	55.8	26.9	3540	10.6	71 ... 160	15100	17300	30100	35700	8010	8800	
305L3	53.4	28.1	4000	12.9	71 ... 160	14900	17000	29700	35200	7900	8800	
305L3	63.1	23.8	4720	12.9	71 ... 160	15700	18000	31200	37000	8340	8800	
305L3	72.3	20.8	4160	9.9	71 ... 160	16500	18800	32500	38600	8730	8800	
305L3	77.2	19.4	4820	10.7	71 ... 160	16800	19200	33200	39300	8930	8800	
305L3	90.2	16.6	4260	8.1	71 ... 160	17700	20300	34800	41200	9400	8800	
305L3	105	14.4	5030	8.3	71 ... 160	18600	21300	36300	43100	9880	8800	
305L3	113	13.3	3590	5.5	71 ... 160	19100	21800	37200	44100	10100	8800	
305L3	124	12.1	3590	5.0	71 ... 160	19700	22600	38300	45400	10500	8800	
305L3	141	10.6	5180	6.3	71 ... 160	20600	23500	39800	47200	10900	8800	
305L3	152	9.8	3600	4.1	71 ... 160	21000	24000	40500	48000	11200	8800	
305L3	164	9.2	4410	4.6	71 ... 160	21000	24000	40500	48000	11500	8800	
305L3	178	8.5	4420	4.3	71 ... 160	21000	24000	40500	48000	11800	8800	
305L3	190	7.9	3600	3.3	71 ... 160	21000	24000	40500	48000	12100	8800	
305L3	220	6.8	4750	3.7	71 ... 160	21000	24000	40500	48000	12700	8800	
305L3	258	5.8	3600	2.4	71 ... 160	21000	24000	40500	48000	13300	8800	
305L3	276	5.4	4460	2.8	71 ... 160	21000	24000	40500	48000	13700	8800	
305L3	321	4.7	3640	1.9	71 ... 160	21200	24200	40900	48500	14400	8800	
305L3	389	3.9	3170	1.4	71 ... 160	21800	24900	42000	49800	15300	8800	
305L3	402	3.7	3760	1.6	71 ... 160	21900	25000	42200	50000	15500	8800	
305L4	413	3.6	4720	2.0	71 ... 160	22000	25100	42400	50200	15600	8800	
305L4	446	3.4	5490	2.2	71 ... 160	22200	25400	42900	50800	16000	8800	
305L4	492	3.0	5340	1.9	71 ... 160	22500	25800	43500	51500	16600	8800	
305L4	556	2.7	5500	1.8	71 ... 160	22900	26200	44200	52400	17200	8800	
305L4	649	2.3	4510	1.2	71 ... 160	23400	26800	45200	53600	18200	8800	
305L4	718	2.1	4130	1.0	71 ... 160	23800	27200	45900	54400	18800	8800	
305L4	816	1.8	5410	1.2	71 ... 160	24200	27700	46700	55400	19600	8800	



305 L 

5800 Nm

n ₁ min ⁻¹		i	n ₂ min ⁻¹	M _{n2} Nm	P _{n1} kW	P (IEC) 	Rn ₂ [N]					M _{2 max} Nm
							MC	MZ	HC/PC	HZ/PZ	FZ	
1500	305L4	896	1.7	4290	0.85	71 ... 160	24600	28100	47400	56100	20200	8800
	305L4	1018	1.5	5450	0.95	71 ... 160	25000	28600	48200	57200	21100	8800
	305L4	1098	1.4	4440	0.72	71 ... 160	25300	28900	48700	57800	21600	8800
	305L4	1278	1.2	5500	0.76	71 ... 160	25800	29500	49800	59000	22800	8800
	305L4	1370	1.1	4620	0.60	71 ... 160	26100	29800	50300	59600	23300	8800
	305L4	1586	0.95	4750	0.53	71 ... 160	26600	30400	51400	60900	24000	8800
	305L4	1854	0.81	4690	0.45	71 ... 160	27200	31100	52500	62300	24000	8800
	305L4	1991	0.75	5600	0.50	71 ... 160	27500	31500	53100	62900	24000	8800
	305L4	2243	0.67	3800	0.30	71 ... 160	28000	32000	54000	64000	24000	8800
	305L4	2799	0.54	3800	0.24	71 ... 160	28900	33000	55700	66000	24000	8800
1000	305L1	3.60	278	2680	60	132 ... 200	6930	7920	14900	17700	3680	8800
	305L1	4.25	235	2770	60	132 ... 200	7330	8380	15700	18600	3890	8800
	305L1	5.33	188	2890	58	132 ... 200	7900	9030	16800	19900	4190	8800
	305L1	6.20	161	3000	52	132 ... 200	8310	9500	17600	20800	4410	8800
	305L1	7.50	133	2560	37	132 ... 200	8860	10100	18600	22100	4700	8800
	305L2	12.5	80	3300	29.4	71 ... 160	10500	12000	21700	25700	5570	8800
	305L2	15.3	65	3460	25.1	71 ... 160	11200	12800	23100	27400	5960	8800
	305L2	18.1	55	4090	25.1	71 ... 160	11900	13600	24300	28800	6300	8800
	305L2	20.8	48	3650	19.5	71 ... 160	12400	14200	25300	30000	6600	8800
	305L2	22.7	44	4290	21.0	71 ... 160	12800	14600	26000	30800	6800	8800
	305L2	24.5	41	4200	19.1	71 ... 160	13100	15000	26600	31500	6970	8800
	305L2	26.4	38	3560	15.0	71 ... 160	13500	15400	27200	32200	7150	8800
	305L2	30.8	33	4310	15.6	71 ... 160	14200	16200	28400	33700	7520	8800
	305L2	35.8	28.0	3570	11.1	71 ... 160	14900	17000	29800	35300	7910	8800
	305L2	38.4	26.0	4330	12.5	71 ... 160	15300	17400	30400	36000	8100	8800
	305L2	44.6	22.4	3570	8.9	71 ... 160	16000	18300	31800	37700	8510	8800
	305L2	55.8	17.9	3560	7.1	71 ... 160	17300	19800	34000	40300	9170	8800
	305L3	53.4	18.7	4190	9.0	71 ... 160	17000	19500	33600	39800	9040	8800
	305L3	63.1	15.9	4980	9.1	71 ... 160	18000	20600	35300	41800	9550	8800
	305L3	72.3	13.8	4340	6.9	71 ... 160	18800	21500	36700	43500	10000	8800
	305L3	77.2	12.9	5110	7.6	71 ... 160	19300	22000	37500	44400	10200	8800
	305L3	90.2	11.1	4440	5.7	71 ... 160	20300	23200	39300	46500	10800	8800
	305L3	105	9.6	5310	5.8	71 ... 160	21000	24000	40500	48000	11300	8800
	305L3	113	8.9	3600	3.7	71 ... 160	21000	24000	40500	48000	11600	8800
	305L3	124	8.0	3600	3.3	71 ... 160	21000	24000	40500	48000	12000	8800
	305L3	141	7.1	5260	4.3	71 ... 160	21000	24000	40500	48000	12500	8800
	305L3	152	6.6	3600	2.7	71 ... 160	21000	24000	40500	48000	12800	8800
	305L3	164	6.1	4450	3.1	71 ... 160	21000	24000	40500	48000	13100	8800
	305L3	178	5.6	4460	2.9	71 ... 160	21000	24000	40500	48000	13500	8800
	305L3	190	5.3	3600	2.2	71 ... 160	21000	24000	40500	48000	13800	8800
	305L3	220	4.5	4750	2.5	71 ... 160	21300	24300	41100	48700	14500	8800
	305L3	258	3.9	3740	1.7	71 ... 160	21800	24900	42000	49800	15300	8800
	305L3	276	3.6	4670	1.9	71 ... 160	22000	25100	42400	50300	15600	8800
	305L3	321	3.1	3870	1.4	71 ... 160	22500	25700	43300	51400	16400	8800
	305L3	389	2.6	3290	0.97	71 ... 160	23100	26400	44500	52800	17500	8800
	305L3	402	2.5	4000	1.1	71 ... 160	23200	26500	44700	53000	17700	8800
	305L4	413	2.4	5060	1.4	71 ... 160	23300	26600	44900	53200	17900	8800
	305L4	446	2.2	5530	1.5	71 ... 160	23500	26900	45400	53800	18300	8800
	305L4	492	2.0	5390	1.3	71 ... 160	23900	27300	46100	54600	19000	8800
	305L4	556	1.8	5610	1.2	71 ... 160	24300	27800	46900	55600	19700	8800
	305L4	649	1.5	4600	0.84	71 ... 160	24800	28400	47900	56800	20800	8800
	305L4	718	1.4	4430	0.73	71 ... 160	25200	28800	48600	57600	21500	8800
305L4	816	1.2	5490	0.80	71 ... 160	25700	29300	49500	58700	22400	8800	
305L4	896	1.1	4600	0.61	71 ... 160	26000	29700	50200	59500	23100	8800	
305L4	1018	0.98	5530	0.64	71 ... 160	26500	30300	51100	60600	24000	8800	
305L4	1098	0.91	4690	0.51	71 ... 160	26800	30600	51700	61200	24000	8800	
305L4	1278	0.78	5600	0.52	71 ... 160	27400	31300	52800	62600	24000	8800	
305L4	1370	0.73	4690	0.40	71 ... 160	27600	31600	53300	63200	24000	8800	
305L4	1586	0.63	4750	0.35	71 ... 160	28200	32300	54400	64500	24000	8800	
305L4	1854	0.54	4690	0.30	71 ... 160	28900	33000	55700	66000	24000	8800	
305L4	1991	0.50	5600	0.33	71 ... 160	29200	33300	56200	66700	24000	8800	

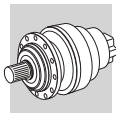

B



305 L



5800 Nm

n ₁ min ⁻¹		i	n ₂ min ⁻¹	M _{n2} Nm	P _{n1} kW	P (IEC) 	Rn ₂ [N]					M _{2 max} Nm
							MC	MZ	HC/PC	HZ/PZ	FZ	
1000	305L4	2243	0.45	3800	0.20	71 ... 160	29700	33900	57200	67800	24000	8800
	305L4	2799	0.36	3800	0.16	71 ... 160	30600	35000	59000	70000	24000	8800
500	305L1	3.60	139	3300	49	132 ... 200	8740	9980	18400	21800	4630	8800
	305L1	4.25	118	3410	43	132 ... 200	9230	10600	19300	22900	4900	8800
	305L1	5.33	94	3560	36	132 ... 200	9960	11400	20700	24500	5280	8800
	305L1	6.20	81	3490	30	132 ... 200	10500	12000	21700	25700	5560	8800
	305L1	7.50	67	2910	20.9	132 ... 200	11200	12800	22900	27200	5920	8800
	305L2	12.5	40	3890	17.3	71 ... 160	13200	15100	26700	31700	7020	8800
	305L2	15.3	33	3930	14.3	71 ... 160	14200	16200	28400	33700	7510	8800
	305L2	18.1	27.6	4580	14.1	71 ... 160	15000	17100	29900	35400	7940	8800
	305L2	20.8	24.1	3970	10.6	71 ... 160	15700	17900	31100	36900	8310	8800
	305L2	22.7	22.0	4340	10.6	71 ... 160	16100	18500	32000	37900	8570	8800
	305L2	24.5	20.4	4680	10.6	71 ... 160	16600	18900	32700	38800	8780	8800
	305L2	26.4	18.9	3580	7.5	71 ... 160	17000	19400	33500	39600	9010	8800
	305L2	30.8	16.3	4360	7.9	71 ... 160	17900	20400	35000	41500	9480	8800
	305L2	35.8	14.0	3590	5.6	71 ... 160	18800	21500	36600	43400	9960	8800
	305L2	38.4	13.0	4380	6.3	71 ... 160	19200	22000	37400	44300	10200	8800
	305L2	44.6	11.2	3600	4.5	71 ... 160	20200	23100	39100	46400	10700	8800
	305L2	55.8	9.0	3600	3.6	71 ... 160	21000	24000	40500	48000	11600	8800
	305L3	53.4	9.4	4490	4.8	71 ... 160	21000	24000	40500	48000	11400	8800
	305L3	63.1	7.9	5360	4.9	71 ... 160	21000	24000	40500	48000	12000	8800
	305L3	72.3	6.9	4490	3.6	71 ... 160	21000	24000	40500	48000	12600	8800
	305L3	77.2	6.5	5410	4.0	71 ... 160	21000	24000	40500	48000	12900	8800
	305L3	90.2	5.5	4490	2.9	71 ... 160	21000	24000	40500	48000	13600	8800
	305L3	105	4.8	5480	3.0	71 ... 160	21100	24200	40800	48300	14200	8800
	305L3	113	4.4	3670	1.9	71 ... 160	21400	24400	41200	48800	14600	8800
	305L3	124	4.0	3720	1.7	71 ... 160	21700	24800	41800	49500	15100	8800
	305L3	141	3.5	5320	2.2	71 ... 160	22100	25200	42600	50400	15800	8800
	305L3	152	3.3	3840	1.4	71 ... 160	22300	25500	43000	51000	16200	8800
	305L3	164	3.1	4870	1.7	71 ... 160	22500	25800	43500	51500	16500	8800
	305L3	178	2.8	4940	1.6	71 ... 160	22800	26100	44000	52100	17000	8800
	305L3	190	2.6	3970	1.2	71 ... 160	23000	26300	44400	52600	17400	8800
	305L3	220	2.3	4750	1.2	71 ... 160	23500	26900	45300	53700	18300	8800
	305L3	258	1.9	4180	0.93	71 ... 160	24000	27500	46400	54900	19200	8800
	305L3	276	1.8	5140	1.1	71 ... 160	24300	27800	46800	55500	19700	8800
	305L3	321	1.6	4340	0.78	71 ... 160	24800	28400	47900	56700	20700	8800
	305L3	389	1.3	3660	0.54	71 ... 160	25500	29100	49200	58300	22100	8800
	305L3	402	1.2	4520	0.64	71 ... 160	25600	29300	49400	58500	22300	8800
	305L4	413	1.2	5480	0.78	71 ... 160	25700	29400	49600	58800	22500	8800
	305L4	446	1.1	5760	0.76	71 ... 160	26000	29700	50100	59400	23100	8800
	305L4	492	1.0	5530	0.66	71 ... 160	26400	30100	50900	60300	23900	8800
	305L4	556	0.9	5800	0.62	71 ... 160	26800	30700	51700	61300	24000	8800
	305L4	649	0.77	4700	0.43	71 ... 160	27400	31400	52900	62700	24000	8800
	305L4	718	0.70	4690	0.39	71 ... 160	27800	31800	53700	63600	24000	8800
305L4	816	0.61	5530	0.4	71 ... 160	28300	32400	54700	64800	24000	8800	
305L4	896	0.56	4690	0.31	71 ... 160	28700	32800	55400	65700	24000	8800	
305L4	1018	0.49	5530	0.32	71 ... 160	29300	33400	56400	66900	24000	8800	
305L4	1098	0.46	4690	0.25	71 ... 160	29600	33800	57000	67600	24000	8800	
305L4	1278	0.39	5600	0.26	71 ... 160	30200	34500	58300	69100	24000	8800	
305L4	1370	0.36	4690	0.2	71 ... 160	30500	34900	58900	69800	24000	8800	
305L4	1586	0.32	4750	0.18	71 ... 160	31200	35600	60100	71200	24000	8800	
305L4	1854	0.27	4690	0.15	71 ... 160	31900	36400	61500	72800	24000	8800	
305L4	1991	0.25	5600	0.17	71 ... 160	32200	36800	62100	73600	24000	8800	
305L4	2243	0.22	3800	0.1	71 ... 160	32700	37400	63200	74000	24000	8800	
305L4	2799	0.18	3800	0.08	71 ... 160	33800	38600	64000	74000	24000	8800	

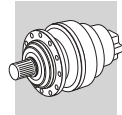

B



306 L



10840 Nm

n ₁ min ⁻¹		i	n ₂ min ⁻¹	M _{n2} Nm	P _{n1} kW	P (IEC) 	Rn ₂ [N]					M _{2 max} Nm
							MC	MZ	HC/PC	HZ/PZ	FZ	
1500	306L1	3.60	417	3760	75	160 ... 250	7210	8220	18600	21500	4690	14900
	306L1	4.25	353	3890	75	160 ... 250	7620	8690	19600	22600	4950	14900
	306L1	5.33	281	4060	75	160 ... 250	8220	9370	20900	24200	5340	14900
	306L1	6.20	242	4200	75	160 ... 250	8640	9850	21900	25300	5620	14900
	306L1	7.50	200	4090	75	160 ... 250	9210	10500	23200	26800	5980	14900
	306L2	13.0	116	4820	40	132 ... 200	11100	12600	27300	31600	7180	14900
	306L2	15.3	98	4990	40	132 ... 200	11700	13300	28700	33200	7590	14900
	306L2	18.1	83	5890	40	132 ... 200	12300	14100	30200	34900	8020	14900
	306L2	22.7	66	6140	40	132 ... 200	13300	15200	32300	37300	8650	14900
	306L2	26.4	57	6370	40	132 ... 200	14000	16000	33800	39100	9100	14900
	306L2	28.4	53	6700	39	132 ... 200	14400	16400	34600	40000	9330	14900
	306L2	33.1	45	6870	35	132 ... 200	15100	17200	36200	41800	9810	14900
	306L2	38.4	39	6470	28.1	132 ... 200	15900	18100	37900	43700	10300	14900
	306L2	46.5	32	6470	23.2	132 ... 200	16900	19300	40100	46300	11000	14900
	306L2	56.3	26.7	5210	15.5	132 ... 200	18000	20600	42500	49000	11700	14900
	306L2	72.5	20.7	5290	12.2	132 ... 200	19600	22400	45800	52900	12700	14900
	306L3	53.2	28.2	7100	20.0	71 ... 160	17700	20200	41800	48200	11500	14900
	306L3	65.2	23.0	7480	19.7	71 ... 160	18900	21600	44400	51300	12300	14900
	306L3	77.0	19.5	8350	18.7	71 ... 160	20000	22800	46700	53900	13000	14900
	306L3	81.9	18.3	6890	14.5	71 ... 160	20400	23300	47500	54900	13300	14900
	306L3	88.3	17.0	8550	16.7	71 ... 160	20900	23900	48600	56100	13600	14900
	306L3	104	14.4	8900	14.7	71 ... 160	22100	25200	51100	59000	14400	14900
	306L3	112	13.4	7410	11.3	71 ... 160	22700	25900	52300	60300	14800	14900
	306L3	121	12.4	7790	11.1	71 ... 160	23300	26500	53500	61700	15100	14900
	306L3	141	10.6	7900	9.6	71 ... 160	24500	27900	55900	64600	15900	14900
	306L3	152	9.9	7590	8.6	71 ... 160	25000	28500	57000	65800	16300	14900
	306L3	190	7.9	6510	5.9	71 ... 160	25000	28500	57000	65800	17600	14900
	306L3	205	7.3	8110	6.8	71 ... 160	25000	28500	57000	65800	18000	14900
	306L3	222	6.8	6520	5.1	71 ... 160	25000	28500	57000	65800	18500	14900
	306L3	238	6.3	8180	5.9	71 ... 160	25000	28500	57000	65800	19000	14900
	306L3	268	5.6	5500	3.5	71 ... 160	25000	28500	57000	65800	19700	14900
	306L3	288	5.2	5500	3.3	71 ... 160	25000	28500	57000	65800	20200	14900
	306L3	325	4.6	5540	2.9	71 ... 160	25300	28800	57600	66500	21000	14900
	306L3	405	3.7	5670	2.4	71 ... 160	26100	29700	59500	68700	22600	14900
	306L4	391	3.8	6840	3.1	71 ... 160	26000	29600	59200	68300	22400	14900
	306L4	444	3.4	9850	3.9	71 ... 160	26400	30100	60300	69600	23300	14900
	306L4	509	2.9	9450	3.3	71 ... 160	27000	30700	61500	71000	24400	14900
	306L4	589	2.5	9320	2.8	71 ... 160	27500	31400	62800	72500	25600	14900
	306L4	636	2.4	9450	2.6	71 ... 160	27800	31700	63500	73200	26300	14900
	306L4	700	2.1	9470	2.4	71 ... 160	28200	32200	64300	74300	27100	14900
	306L4	809	1.9	7690	1.7	71 ... 160	28800	32800	65700	75800	28500	14900
	306L4	877	1.7	7710	1.6	71 ... 160	29100	33200	66400	76700	29300	14900
	306L4	1015	1.5	9460	1.7	71 ... 160	29800	33900	67800	78300	30700	14900
	306L4	1095	1.4	7790	1.3	71 ... 160	30100	34300	68600	79200	31500	14900
	306L4	1279	1.2	8400	1.2	71 ... 160	30800	35100	70100	80900	33200	14900
	306L4	1475	1.0	10100	1.2	71 ... 160	31400	35800	71600	82600	34800	14900
	306L4	1597	0.94	8630	0.96	71 ... 160	31700	36200	72400	83600	35000	14900
	306L4	1843	0.81	10100	0.97	71 ... 160	32400	36900	73900	85300	35000	14900
	306L4	2074	0.72	7000	0.60	71 ... 160	33000	37600	75100	86700	35000	14900
	306L4	2337	0.64	7000	0.53	71 ... 160	33500	38200	76400	88200	35000	14900
306L4	2916	0.51	7000	0.43	71 ... 160	34600	39400	78900	91100	35000	14900	
1000	306L1	3.60	278	4250	75	160 ... 250	8250	9410	21000	24300	5360	14900
	306L1	4.25	235	4390	75	160 ... 250	8720	9950	22100	25500	5670	14900
	306L1	5.33	188	4580	75	160 ... 250	9410	10700	23700	27300	6120	14900
	306L1	6.20	161	4750	75	160 ... 250	9890	11300	24800	28600	6430	14900
	306L1	7.50	133	4620	67	160 ... 250	10500	12000	26200	30300	6850	14900
	306L2	13.0	77	5450	40	132 ... 200	12700	14400	30900	35600	8220	14900
	306L2	15.3	65	5640	40	132 ... 200	13400	15200	32500	37500	8690	14900
	306L2	18.1	55	6650	40	132 ... 200	14100	16100	34100	39400	9180	14900
	306L2	22.7	44	6840	34	132 ... 200	15200	17400	36500	42200	9910	14900

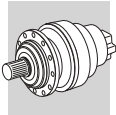

B



306 L



10840 Nm

n ₁ min ⁻¹		i	n ₂ min ⁻¹	M _{n2} Nm	P _{n1} kW	P (IEC) 	Rn ₂ [N]					M _{2 max} Nm	
							MC	MZ	HC/PC	HZ/PZ	FZ		
1000	306L2	26.4	38	6780	28.6	132 ... 200	16000	18300	38200	44100	10400	14900	
	306L2	28.4	35	7040	27.6	132 ... 200	16400	18700	39100	45100	10700	14900	
	306L2	33.1	30	7150	24.1	132 ... 200	17300	19700	40900	47200	11200	14900	
	306L2	38.4	26.0	6480	18.7	132 ... 200	18200	20700	42800	49400	11800	14900	
	306L2	46.5	21.5	6480	15.5	132 ... 200	19400	22100	45300	52300	12600	14900	
	306L2	56.3	17.8	5330	10.5	132 ... 200	20600	23500	48000	55400	13400	14900	
	306L2	72.5	13.8	5400	8.3	132 ... 200	22500	25600	51800	59700	14600	14900	
	306L3	53.2	18.8	7890	17.0	71 ... 160	20300	23100	47200	54500	13200	14900	
	306L3	65.2	15.3	8320	14.6	71 ... 160	21700	24700	50100	57900	14100	14900	
	306L3	77.0	13.0	9090	13.5	71 ... 160	22900	26100	52700	60800	14900	14900	
	306L3	81.9	12.2	7310	10.2	71 ... 160	23400	26700	53700	62000	15200	14900	
	306L3	88.3	11.3	9230	12.0	71 ... 160	24000	27300	54900	63400	15600	14900	
	306L3	104	9.6	9610	10.6	71 ... 160	25000	28500	57000	65800	16500	14900	
	306L3	112	8.9	7590	7.8	71 ... 160	25000	28500	57000	65800	16900	14900	
	306L3	121	8.2	8050	7.6	71 ... 160	25000	28500	57000	65800	17300	14900	
	306L3	141	7.1	8120	6.6	71 ... 160	25000	28500	57000	65800	18200	14900	
	306L3	152	6.6	7590	5.7	71 ... 160	25000	28500	57000	65800	18700	14900	
	306L3	190	5.3	6530	3.9	71 ... 160	25000	28500	57000	65800	20100	14900	
	306L3	205	4.9	8330	4.7	71 ... 160	25100	28600	57200	66000	20600	14900	
	306L3	222	4.5	6650	3.4	71 ... 160	25400	28900	57800	66800	21200	14900	
	306L3	238	4.2	8550	4.1	71 ... 160	25600	29200	58400	67500	21700	14900	
	306L3	268	3.7	5670	2.4	71 ... 160	26100	29700	59400	68600	22600	14900	
	306L3	288	3.5	5710	2.3	71 ... 160	26300	30000	60000	69300	23100	14900	
	306L3	325	3.1	5780	2.0	71 ... 160	26800	30500	61100	70500	24100	14900	
	306L3	405	2.5	5910	1.7	71 ... 160	27700	31500	63000	72800	25900	14900	
	306L4	391	2.6	7340	2.2	71 ... 160	27500	31400	62700	72400	25600	14900	
	306L4	444	2.3	9910	2.6	71 ... 160	28000	31900	63900	73700	26700	14900	
	306L4	509	2.0	9450	2.2	71 ... 160	28600	32600	65100	75200	27900	14900	
	306L4	589	1.7	9650	1.9	71 ... 160	29200	33300	66500	76800	29300	14900	
	306L4	636	1.6	9450	1.8	71 ... 160	29500	33600	67200	77600	30100	14900	
	306L4	700	1.4	9790	1.7	71 ... 160	29900	34100	68200	78700	31100	14900	
	306L4	809	1.2	7820	1.1	71 ... 160	30500	34800	69600	80300	32600	14900	
	306L4	877	1.1	7850	1.1	71 ... 160	30900	35200	70400	81300	33500	14900	
	306L4	1015	0.99	9540	1.1	71 ... 160	31500	35900	71900	83000	35000	14900	
	306L4	1095	0.91	7890	0.85	71 ... 160	31900	36300	72700	83900	35000	14900	
	306L4	1279	0.78	8630	0.80	71 ... 160	32600	37200	74300	85800	35000	14900	
	306L4	1475	0.68	10100	0.81	71 ... 160	33300	37900	75800	87500	35000	14900	
	306L4	1597	0.63	8630	0.64	71 ... 160	33600	38300	76700	88500	35000	14900	
	306L4	1843	0.54	10100	0.65	71 ... 160	34300	39100	78300	90400	35000	14900	
	306L4	2074	0.48	7000	0.40	71 ... 160	34900	39800	79600	91900	35000	14900	
	306L4	2337	0.43	7000	0.35	71 ... 160	35500	40500	81000	93500	35000	14900	
	306L4	2916	0.34	7000	0.28	71 ... 160	36700	41800	83600	96500	35000	14900	
	500	306L1	3.60	139	5230	75	160 ... 250	10400	11900	25900	29900	6760	14900
		306L1	4.25	118	5410	69	160 ... 250	11000	12500	27200	31400	7140	14900
		306L1	5.33	94	5640	57	160 ... 250	11900	13500	29100	33600	7700	14900
306L1		6.20	81	5770	50	160 ... 250	12500	14200	30500	35200	8100	14900	
306L1		7.50	67	5040	36	160 ... 250	13300	15100	32300	37200	8630	14900	
306L2		13.0	39	6470	27.8	132 ... 200	15900	18200	38000	43900	10400	14900	
306L2		15.3	33	6830	24.8	132 ... 200	16800	19200	40000	46100	10900	14900	
306L2		18.1	27.7	7760	23.9	132 ... 200	17800	20300	42000	48500	11600	14900	
306L2		22.7	22.1	7820	19.2	132 ... 200	19200	21900	45000	51900	12500	14900	
306L2		26.4	19.0	7190	15.2	132 ... 200	20200	23000	47000	54300	13100	14900	
306L2		28.4	17.6	7530	14.7	132 ... 200	20700	23600	48100	55600	13500	14900	
306L2		33.1	15.1	7640	12.9	132 ... 200	21800	24800	50400	58100	14200	14900	
306L2		38.4	13.0	6490	9.4	132 ... 200	22900	26100	52700	60800	14900	14900	
306L2		46.5	10.8	6500	7.8	132 ... 200	24400	27800	55800	64400	15900	14900	
306L2		56.3	8.9	5500	5.4	132 ... 200	25000	28500	57000	65800	16900	14900	
306L2		72.5	6.9	5500	4.2	132 ... 200	25000	28500	57000	65800	18400	14900	
306L3		53.2	9.4	9300	10.0	71 ... 160	25000	28500	57000	65800	16600	14900	
306L3		65.2	7.7	9320	8.2	71 ... 160	25000	28500	57000	65800	17800	14900	

B

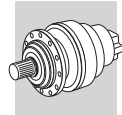

306 L

308

10840 Nm

n ₁ min ⁻¹		i	n ₂ min ⁻¹	M _{n2} Nm	P _{n1} kW	P (IEC)	Rn ₂ [N]					M _{2 max} Nm
							MC	MZ	HC/PC	HZ/PZ	FZ	
500	306L3	77.0	6.5	9750	7.3	71 ... 160	25000	28500	57000	65800	18800	14900
	306L3	81.9	6.1	7650	5.4	71 ... 160	25000	28500	57000	65800	19100	14900
	306L3	88.3	5.7	9450	6.1	71 ... 160	25000	28500	57000	65800	19600	14900
	306L3	104	4.8	9850	5.4	71 ... 160	25100	28700	57300	66200	20800	14900
	306L3	112	4.5	7590	3.9	71 ... 160	25400	29000	58000	66900	21300	14900
	306L3	121	4.1	8580	4.1	71 ... 160	25700	29300	58600	67600	21800	14900
	306L3	141	3.5	8800	3.6	71 ... 160	26300	29900	59900	69100	23000	14900
	306L3	152	3.3	7590	2.9	71 ... 160	26500	30300	60500	69900	23500	14900
	306L3	190	2.6	7300	2.2	71 ... 160	27400	31200	62500	72100	25300	14900
	306L3	205	2.4	9370	2.6	71 ... 160	27700	31600	63100	72900	26000	14900
	306L3	222	2.3	7500	1.9	71 ... 160	28000	31900	63900	73700	26700	14900
	306L3	238	2.1	9390	2.3	71 ... 160	28300	32300	64500	74500	27300	14900
	306L3	268	1.9	6230	1.3	71 ... 160	28800	32800	65600	75800	28400	14900
	306L3	288	1.7	6320	1.3	71 ... 160	29100	33100	66300	76500	29100	14900
	306L3	325	1.5	6460	1.1	71 ... 160	29600	33700	67400	77900	30300	14900
	306L3	405	1.2	6730	0.95	71 ... 160	30500	34800	69600	80400	32600	14900
	306L4	391	1.3	8270	1.3	71 ... 160	30400	34600	69300	79900	32200	14900
	306L4	444	1.1	10300	1.4	71 ... 160	30900	35300	70500	81400	33600	14900
	306L4	509	0.98	9450	1.1	71 ... 160	31500	36000	71900	83000	35000	14900
	306L4	589	0.85	10100	1.0	71 ... 160	32200	36700	73400	84800	35000	14900
	306L4	636	0.79	9450	0.88	71 ... 160	32600	37100	74200	85700	35000	14900
	306L4	700	0.71	10100	0.85	71 ... 160	33000	37600	75300	86900	35000	14900
	306L4	809	0.62	7890	0.58	71 ... 160	33700	38400	76800	88700	35000	14900
	306L4	877	0.57	7890	0.53	71 ... 160	34100	38900	77700	89700	35000	14900
	306L4	1015	0.49	9540	0.56	71 ... 160	34800	39700	79400	91600	35000	14900
	306L4	1095	0.46	7890	0.43	71 ... 160	35200	40100	80200	92600	35000	14900
	306L4	1279	0.39	8630	0.40	71 ... 160	36000	41000	82000	94700	35000	14900
	306L4	1475	0.34	10100	0.40	71 ... 160	36700	41900	83700	96600	35000	14900
	306L4	1597	0.31	8630	0.32	71 ... 160	37100	42300	84700	97700	35000	14900
	306L4	1843	0.27	10100	0.32	71 ... 160	37900	43200	86400	99800	35000	14900
	306L4	2074	0.24	7000	0.20	71 ... 160	38600	43900	87900	101500	35000	14900
	306L4	2337	0.21	7000	0.18	71 ... 160	39200	44700	89400	103200	35000	14900
	306L4	2916	0.17	7000	0.14	71 ... 160	40500	46100	92300	106500	35000	14900

307 L

320

15680 Nm

n ₁ min ⁻¹		i	n ₂ min ⁻¹	M _{n2} Nm	P _{n1} kW	P (IEC)	Rn ₂ [N]					M _{2 max} Nm
							MC	MZ	HC/PC	HZ/PZ	FZ	
1500	307L1	3.43	438	5110	115	180 ... 250	8510	10600	21700	28600	5930	18600
	307L1	4.09	367	5260	115	180 ... 250	9030	11300	22900	30100	6290	21000
	307L1	5.25	286	5540	115	180 ... 250	9810	12300	24700	32500	6830	21000
	307L1	6.23	241	5750	115	180 ... 250	10400	13000	26000	34200	7230	21000
	307L2	12.3	122	7510	60	132 ... 200	13000	16300	31900	42000	9080	18600
	307L2	14.7	102	7730	60	132 ... 200	13800	17300	33600	44300	9640	21000
	307L2	17.4	86	8120	60	132 ... 200	14600	18300	35400	46500	10200	21000
	307L2	21.8	69	8690	60	132 ... 200	15800	19700	37900	49800	11000	21000
	307L2	25.4	59	9090	60	132 ... 200	16600	20700	39600	52100	11600	21000
	307L2	28.0	54	9150	55	132 ... 200	17100	21400	40800	53700	11900	21000
	307L2	30.7	49	9590	52	132 ... 200	17700	22100	41900	55200	12300	21000
	307L2	32.6	46	9410	48	132 ... 200	18000	22500	42700	56200	12600	21000
	307L2	38.6	39	8310	36	132 ... 200	19100	23900	44900	59100	13300	21000
	307L2	46.7	32	8360	29.9	132 ... 200	20300	25400	47600	62600	14200	21000
	307L3	51.3	29.3	10700	30	71 ... 160	21000	26200	48900	64300	14600	21000
	307L3	60.5	24.8	11100	30	71 ... 160	22200	27700	51400	67600	15400	21000
	307L3	74.1	20.2	11600	27.0	71 ... 160	23700	29600	54600	71900	16500	21000
	307L3	80.6	18.6	10200	21.8	71 ... 160	24400	30500	56000	73700	17000	21000
	307L3	93.0	16.1	12200	22.6	71 ... 160	25600	32000	58500	76900	17800	21000
	307L3	100	15.0	12400	21.3	71 ... 160	26200	32800	59800	78700	18300	21000
	307L3	113	13.2	10500	16.0	71 ... 160	27300	34100	62000	81600	19000	21000

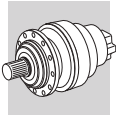

B



307 L



15680 Nm

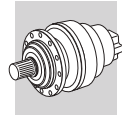

n ₁ min ⁻¹		i	n ₂ min ⁻¹	M _{n2} Nm	P _{n1} kW	P (IEC) 	Rn ₂ [N]					M _{2 max} Nm	
							MC	MZ	HC/PC	HZ/PZ	FZ		
1500	307L3	126	11.9	13000	17.8	71 ... 160	28300	35400	64000	84200	19700	21000	
	307L3	139	10.8	10700	13.3	71 ... 160	29200	36500	65900	86800	20400	21000	
	307L3	146	10.3	13400	15.8	71 ... 160	29800	37200	67000	88100	20700	21000	
	307L3	162	9.3	10800	11.6	71 ... 160	30000	37500	67500	88800	21400	21000	
	307L3	177	8.5	12300	12.0	71 ... 160	30000	37500	67500	88800	22100	21000	
	307L3	202	7.4	11000	9.4	71 ... 160	30000	37500	67500	88800	23100	21000	
	307L3	221	6.8	12700	9.9	71 ... 160	30000	37500	67500	88800	23800	21000	
	307L3	239	6.3	8700	6.3	71 ... 160	30000	37500	67500	88800	24400	21000	
	307L3	284	5.3	11300	6.8	71 ... 160	30000	37500	67500	88800	25800	21000	
	307L3	336	4.5	8840	4.5	71 ... 160	30500	38100	68600	90300	27300	21000	
	307L4	349	4.3	14900	7.6	71 ... 160	30700	38300	69000	90700	27700	21000	
	307L4	406	3.7	11900	5.2	71 ... 160	31300	39100	70500	92700	29100	21000	
	307L4	465	3.2	12200	4.6	71 ... 160	31900	39900	71900	94500	30500	21000	
	307L4	509	2.9	14000	4.9	71 ... 160	32400	40400	72800	95800	31400	21000	
	307L4	579	2.6	14900	4.6	71 ... 160	33000	41200	74100	97500	32800	21000	
	307L4	654	2.3	12900	3.5	71 ... 160	33500	41900	75400	99200	34100	21000	
	307L4	722	2.1	15000	3.7	71 ... 160	34000	42500	76500	100700	35300	21000	
	307L4	801	1.9	13300	3.0	71 ... 160	34500	43100	77700	102200	36500	21000	
	307L4	906	1.7	15200	3.0	71 ... 160	35100	43900	79000	104000	38000	21000	
	307L4	999	1.5	13800	2.5	71 ... 160	35600	44500	80200	105500	39300	21000	
	307L4	1157	1.3	14200	2.2	71 ... 160	36400	45500	81900	107700	41300	21000	
	307L4	1274	1.2	12300	1.7	71 ... 160	36900	46100	83000	109200	42600	21000	
	307L4	1408	1.1	15600	2.0	71 ... 160	37400	46800	84200	110800	44100	21000	
	307L4	1591	0.94	15000	1.7	71 ... 160	38100	47600	85700	112700	45000	21000	
	307L4	1767	0.85	15700	1.6	71 ... 160	38600	48300	87000	114400	45000	21000	
	307L4	2041	0.73	14300	1.2	71 ... 160	39500	49300	88800	116800	45000	21000	
	307L4	2423	0.62	11000	0.81	71 ... 160	40400	50500	91000	119700	45000	21000	
	1000	307L1	3.43	292	5770	115	180 ... 250	9750	12200	24500	32300	6790	18600
		307L1	4.09	244	5940	115	180 ... 250	10300	12900	25900	34000	7200	21000
		307L1	5.25	190	6260	115	180 ... 250	11200	14000	27900	36700	7820	21000
		307L1	6.23	160	6500	113	180 ... 250	11900	14900	29400	38600	8280	21000
		307L2	12.3	81	8060	60	132 ... 200	14900	18700	36000	47400	10400	18600
307L2		14.7	68	8720	60	132 ... 200	15800	19800	38000	50000	11000	21000	
307L2		17.4	58	9170	59	132 ... 200	16700	20900	39900	52500	11700	21000	
307L2		21.8	46	9740	50	132 ... 200	18100	22600	42800	56200	12600	21000	
307L2		25.4	39	10100	44	132 ... 200	19000	23700	44700	58800	13200	21000	
307L2		28.0	36	9630	38	132 ... 200	19600	24500	46100	60600	13700	21000	
307L2		30.7	33	10200	37	132 ... 200	20200	25300	47400	62300	14100	21000	
307L2		32.6	31	9760	33	132 ... 200	20600	25800	48200	63400	14400	21000	
307L2		38.6	25.9	8430	24.3	132 ... 200	21800	27300	50700	66800	15200	21000	
307L2		46.7	21.4	8480	20.2	132 ... 200	23300	29100	53700	70700	16200	21000	
307L3		51.3	19.5	11700	26.2	71 ... 160	24000	30000	55200	72700	16700	21000	
307L3		60.5	16.5	12100	23.0	71 ... 160	25400	31700	58100	76400	17700	21000	
307L3		74.1	13.5	12700	19.6	71 ... 160	27100	33900	61700	81200	18900	21000	
307L3		80.6	12.4	10600	15.1	71 ... 160	27900	34900	63300	83200	19400	21000	
307L3		93.0	10.8	13300	16.4	71 ... 160	29300	36600	66000	86900	20400	21000	
307L3		100	10.0	13500	15.5	71 ... 160	30000	37500	67500	88800	20900	21000	
307L3		113	8.8	10900	11.0	71 ... 160	30000	37500	67500	88800	21800	21000	
307L3		126	7.9	14000	12.7	71 ... 160	30000	37500	67500	88800	22600	21000	
307L3		139	7.2	11000	9.1	71 ... 160	30000	37500	67500	88800	23300	21000	
307L3		146	6.8	13800	10.8	71 ... 160	30000	37500	67500	88800	23700	21000	
307L3		162	6.2	11100	7.9	71 ... 160	30000	37500	67500	88800	24500	21000	
307L3		177	5.6	12300	8.0	71 ... 160	30000	37500	67500	88800	25300	21000	
307L3		202	5.0	11300	6.4	71 ... 160	30000	37500	67600	88900	26400	21000	
307L3		221	4.5	13000	6.8	71 ... 160	30400	38000	68500	90100	27200	21000	
307L3		239	4.2	8920	4.3	71 ... 160	30800	38500	69300	91100	27900	21000	
307L3		284	3.5	12000	4.8	71 ... 160	31500	39400	70900	93300	29600	21000	
307L3		336	3.0	9370	3.2	71 ... 160	32300	40400	72700	95700	31300	21000	
307L4		349	2.9	14900	5.0	71 ... 160	32500	40600	73100	96200	31700	21000	
307L4		406	2.5	12700	3.7	71 ... 160	33200	41500	74700	98200	33300	21000	
307L4		465	2.2	13000	3.3	71 ... 160	33800	42300	76100	100200	34900	21000	

B



307 L  320

15680 Nm

n ₁ min ⁻¹		i	n ₂ min ⁻¹	M _{n2} Nm	P _{n1} kW	P (IEC) 	Rn ₂ [N]					M _{2 max} Nm
							MC	MZ	HC/PC	HZ/PZ	FZ	
1000	307L4	509	2.0	14300	3.3	71 ... 160	34300	42900	77100	101500	35900	21000
	307L4	579	1.7	15200	3.1	71 ... 160	34900	43600	78600	103400	37500	21000
	307L4	654	1.5	13800	2.5	71 ... 160	35500	44400	79900	105200	39100	21000
	307L4	722	1.4	15400	2.5	71 ... 160	36000	45000	81100	106700	40400	21000
	307L4	801	1.2	14300	2.1	71 ... 160	36600	45700	82300	108300	41800	21000
	307L4	906	1.1	15600	2.0	71 ... 160	37200	46500	83800	110200	43500	21000
	307L4	999	1.0	14800	1.8	71 ... 160	37800	47200	84900	111700	45000	21000
	307L4	1157	0.86	14800	1.5	71 ... 160	38500	48200	86700	114100	45000	21000
	307L4	1274	0.78	12300	1.1	71 ... 160	39100	48900	87900	115700	45000	21000
	307L4	1408	0.71	15700	1.3	71 ... 160	39600	49600	89200	117400	45000	21000
	307L4	1591	0.63	15000	1.1	71 ... 160	40300	50400	90800	119400	45000	21000
	307L4	1767	0.57	15700	1.0	71 ... 160	41000	51200	92100	121200	45000	21000
	307L4	2041	0.49	14300	0.83	71 ... 160	41800	52300	94100	123700	45000	21000
	307L4	2423	0.41	11000	0.54	71 ... 160	42800	53600	96400	126800	45000	21000
500	307L1	3.43	146	7110	112	180 ... 250	12300	15300	30200	39700	8550	18600
	307L1	4.09	122	7320	97	180 ... 250	13000	16300	31900	41900	9070	21000
	307L1	5.25	95	7700	79	180 ... 250	14200	17700	34300	45200	9850	21000
	307L1	6.23	80	7720	67	180 ... 250	15000	18700	36100	47500	10400	21000
	307L2	12.3	41	8390	38	132 ... 200	18800	23500	44400	58400	13100	18600
	307L2	14.7	34	10400	39	132 ... 200	20000	25000	46800	61500	13900	21000
	307L2	17.4	28.8	10800	34	132 ... 200	21100	26400	49200	64700	14700	21000
	307L2	21.8	22.9	11300	28.8	132 ... 200	22800	28400	52600	69200	15800	21000
	307L2	25.4	19.7	11700	25.6	132 ... 200	23900	29900	55100	72400	16700	21000
	307L2	28.0	17.9	10200	20.4	132 ... 200	24700	30900	56700	74600	17200	21000
	307L2	30.7	16.3	11400	20.7	132 ... 200	25500	31900	58300	76700	17700	21000
	307L2	32.6	15.4	10400	17.7	132 ... 200	26000	32500	59300	78100	18100	21000
	307L2	38.6	12.9	8620	12.4	132 ... 200	27500	34400	62500	82200	19200	21000
	307L2	46.7	10.7	8680	10.3	132 ... 200	29300	36700	66100	87000	20400	21000
	307L3	51.3	9.8	13600	15.2	71 ... 160	30000	37500	67500	88800	21100	21000
	307L3	60.5	8.3	13900	13.2	71 ... 160	30000	37500	67500	88800	22300	21000
	307L3	74.1	6.7	14300	11.0	71 ... 160	30000	37500	67500	88800	23800	21000
	307L3	80.6	6.2	11100	7.9	71 ... 160	30000	37500	67500	88800	24500	21000
	307L3	93.0	5.4	14700	9.1	71 ... 160	30000	37500	67500	88800	25700	21000
	307L3	100	5.0	14900	8.5	71 ... 160	30000	37500	67500	88800	26300	21000
	307L3	113	4.4	11500	5.8	71 ... 160	30500	38200	68700	90400	27400	21000
	307L3	126	4.0	14900	6.8	71 ... 160	31000	38800	69800	91800	28400	21000
	307L3	139	3.6	11900	4.9	71 ... 160	31400	39300	70700	93100	29400	21000
	307L3	146	3.4	14000	5.5	71 ... 160	31700	39600	71300	93800	29900	21000
	307L3	162	3.1	12300	4.4	71 ... 160	32100	40200	72300	95100	30900	21000
	307L3	177	2.8	12300	4.0	71 ... 160	32500	40700	73200	96300	31800	21000
	307L3	202	2.5	12700	3.6	71 ... 160	33200	41500	74600	98200	33200	21000
	307L3	221	2.3	13900	3.6	71 ... 160	33600	42000	75600	99400	34300	21000
	307L3	239	2.1	9860	2.4	71 ... 160	34000	42500	76500	100600	35200	21000
	307L3	284	1.8	13300	2.7	71 ... 160	34800	43500	78300	103100	37200	21000
	307L3	336	1.5	10400	1.8	71 ... 160	35700	44600	80300	105600	39400	21000
	307L4	349	1.4	15400	2.6	71 ... 160	35900	44800	80700	106200	39900	21000
	307L4	406	1.2	14300	2.1	71 ... 160	36600	45800	82400	108500	42000	21000
	307L4	465	1.1	14700	1.9	71 ... 160	37400	46700	84100	110600	43900	21000
	307L4	509	0.98	15000	1.7	71 ... 160	37900	47300	85200	112000	45000	21000
	307L4	579	0.86	15700	1.6	71 ... 160	38600	48200	86700	114100	45000	21000
	307L4	654	0.77	14800	1.3	71 ... 160	39200	49000	88300	116100	45000	21000
	307L4	722	0.69	15700	1.3	71 ... 160	39800	49700	89500	117800	45000	21000
	307L4	801	0.62	14800	1.1	71 ... 160	40400	50500	90900	119500	45000	21000
	307L4	906	0.55	15700	1.0	71 ... 160	41100	51400	92500	121700	45000	21000
	307L4	999	0.50	14800	0.88	71 ... 160	41700	52100	93800	123400	45000	21000
	307L4	1157	0.43	14800	0.76	71 ... 160	42600	53200	95800	126000	45000	21000
307L4	1274	0.39	12300	0.57	71 ... 160	43200	53900	97100	127700	45000	21000	
307L4	1408	0.36	15700	0.66	71 ... 160	43800	54700	98500	129600	45000	21000	
307L4	1591	0.31	15000	0.56	71 ... 160	44500	55700	100200	131800	45000	21000	
307L4	1767	0.28	15700	0.52	71 ... 160	45200	56500	101700	133800	45000	21000	
307L4	2041	0.24	14300	0.42	71 ... 160	46200	57700	103900	136600	45000	21000	
307L4	2423	0.21	11000	0.27	71 ... 160	47300	59100	106400	140000	45000	21000	

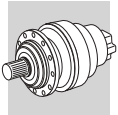

B



309 L



23240 Nm

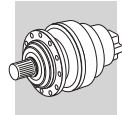

n ₁ min ⁻¹		i	n ₂ min ⁻¹	M _{n2} Nm	P _{n1} kW	P (IEC) 	Rn ₂ [N]					M ₂ max Nm	
							MC	MZ	HC/PC	HZ/PZ	FZ		
1500	309L1	3.43	438	7010	150	180 ... 250	—	—	22200	28600	4740	27900	
	309L1	4.09	367	7220	150	180 ... 250	—	—	23400	30100	5030	29000	
	309L1	5.25	286	7600	150	180 ... 250	—	—	25200	32500	5470	29000	
	309L1	6.23	241	7900	150	180 ... 250	—	—	26600	34200	5790	29000	
	309L2	12.3	122	7890	60	132 ... 200	—	—	32600	42000	7270	27900	
	309L2	14.7	102	9410	60	132 ... 200	—	—	34400	44300	7710	29000	
	309L2	17.4	86	9730	60	132 ... 200	—	—	36100	46500	8150	29000	
	309L2	21.8	69	10100	60	132 ... 200	—	—	38700	49800	8790	29000	
	309L2	25.4	59	10500	60	132 ... 200	—	—	40500	52100	9240	29000	
	309L2	28.0	54	12500	60	132 ... 200	—	—	41700	53700	9550	29000	
	309L2	32.6	46	13000	60	132 ... 200	—	—	43600	56200	10000	29000	
	309L2	38.6	39	12500	54	132 ... 200	—	—	45900	59100	10600	29000	
	309L2	46.7	32	12500	45	132 ... 200	—	—	48600	62600	11300	29000	
	309L3	51.3	29.3	13400	30	71 ... 160	—	—	50000	64300	11700	29000	
	309L3	60.5	24.8	14100	30	71 ... 160	—	—	52500	67600	12300	29000	
	309L3	74.1	20.2	15000	30	71 ... 160	—	—	55800	71900	13200	29000	
	309L3	80.6	18.6	14800	30	71 ... 160	—	—	57300	73700	13600	29000	
	309L3	93.0	16.1	15100	27.9	71 ... 160	—	—	59800	76900	14200	29000	
	309L3	100	15.0	16500	28.3	71 ... 160	—	—	61200	78700	14600	29000	
	309L3	113	13.2	15500	23.6	71 ... 160	—	—	63400	81600	15200	29000	
	309L3	126	11.9	16400	22.4	71 ... 160	—	—	65500	84200	15800	29000	
	309L3	139	10.8	16000	19.9	71 ... 160	—	—	67400	86800	16300	29000	
	309L3	162	9.3	16300	17.3	71 ... 160	—	—	69000	88800	17100	29000	
	309L3	183	8.2	14300	13.5	71 ... 160	—	—	69000	88800	17800	29000	
	309L3	202	7.4	16500	14.1	71 ... 160	—	—	69000	88800	18400	29000	
	309L3	223	6.7	13000	10.0	71 ... 160	—	—	69000	88800	19100	29000	
	309L3	239	6.3	13000	9.4	71 ... 160	—	—	69000	88800	19500	29000	
	309L3	284	5.3	15700	9.6	71 ... 160	—	—	69000	88800	20700	29000	
	309L3	336	4.5	13200	6.8	71 ... 160	—	—	70100	90300	21900	29000	
	309L4	349	4.3	21300	10.8	71 ... 160	—	—	70500	90700	22100	29000	
	309L4	406	3.7	17800	7.8	71 ... 160	—	—	72000	92700	23300	29000	
	309L4	465	3.2	18300	7.0	71 ... 160	—	—	73500	94500	24400	29000	
	309L4	509	2.9	14300	5.0	71 ... 160	—	—	74400	95800	25100	29000	
	309L4	579	2.6	21300	6.5	71 ... 160	—	—	75800	97500	26200	29000	
	309L4	654	2.3	18100	4.9	71 ... 160	—	—	77100	99200	27300	29000	
	309L4	722	2.1	21300	5.2	71 ... 160	—	—	78200	100700	28200	29000	
	309L4	801	1.9	18200	4.0	71 ... 160	—	—	79400	102200	29200	29000	
	309L4	906	1.7	17900	3.5	71 ... 160	—	—	80800	104000	30400	29000	
	309L4	999	1.5	18200	3.2	71 ... 160	—	—	81900	105500	31400	29000	
	309L4	1149	1.3	16200	2.5	71 ... 160	—	—	83600	107600	32900	29000	
	309L4	1286	1.2	16500	2.3	71 ... 160	—	—	84900	109300	34200	29000	
	309L4	1380	1.1	16700	2.2	71 ... 160	—	—	85800	110400	35000	29000	
	309L4	1605	0.93	17000	1.9	71 ... 160	—	—	87700	112800	36000	29000	
	309L4	1723	0.87	17000	1.8	71 ... 160	—	—	88600	114000	36000	29000	
	309L4	2003	0.75	17000	1.5	71 ... 160	—	—	90500	116500	36000	29000	
	309L4	2423	0.62	17000	1.2	71 ... 160	—	—	93000	119700	36000	29000	
1000	309L1	3.43	292	7920	150	180 ... 250	—	—	25100	32300	5430	27900	
	309L1	4.09	244	8150	150	180 ... 250	—	—	26400	34000	5760	29000	
	309L1	5.25	190	8580	150	180 ... 250	—	—	28500	36700	6260	29000	
	309L1	6.23	160	8920	150	180 ... 250	—	—	30000	38600	6620	29000	
		309L2	12.3	81	8900	60	132 ... 200	—	—	36800	47400	8320	27900
		309L2	14.7	68	10600	60	132 ... 200	—	—	38800	50000	8820	29000
		309L2	17.4	58	11000	60	132 ... 200	—	—	40800	52500	9330	29000
		309L2	21.8	46	11400	58	132 ... 200	—	—	43700	56200	10100	29000
		309L2	25.4	39	11500	50	132 ... 200	—	—	45700	58800	10600	29000
		309L2	28.0	36	13500	53	132 ... 200	—	—	47100	60600	10900	29000
		309L2	32.6	31	13800	47	132 ... 200	—	—	49300	63400	11500	29000
		309L2	38.6	25.9	12600	36	132 ... 200	—	—	51900	66800	12200	29000
		309L2	46.7	21.4	12700	30	132 ... 200	—	—	54900	70700	13000	29000



309 L



23240 Nm

n ₁ min ⁻¹		i	n ₂ min ⁻¹	M _{n2} Nm	P _{n1} kW	P (IEC) 	Rn ₂ [N]					M _{2 max} Nm	
							MC	MZ	HC/PC	HZ/PZ	FZ		
1000	309L3	51.3	19.5	14900	30	71 ... 160	—	—	56500	72700	13400	29000	
	309L3	60.5	16.5	16000	30	71 ... 160	—	—	59300	76400	14100	29000	
	309L3	74.1	13.5	17000	26.3	71 ... 160	—	—	63100	81200	15100	29000	
	309L3	80.6	12.4	15700	22.3	71 ... 160	—	—	64700	83200	15500	29000	
	309L3	93.0	10.8	16800	20.7	71 ... 160	—	—	67500	86900	16300	29000	
	309L3	100	10.0	18600	21.3	71 ... 160	—	—	69000	88800	16700	29000	
	309L3	113	8.8	16300	16.5	71 ... 160	—	—	69000	88800	17400	29000	
	309L3	126	7.9	17300	15.7	71 ... 160	—	—	69000	88800	18000	29000	
	309L3	139	7.2	16500	13.7	71 ... 160	—	—	69000	88800	18600	29000	
	309L3	162	6.2	16700	11.9	71 ... 160	—	—	69000	88800	19600	29000	
	309L3	183	5.5	14300	9.0	71 ... 160	—	—	69000	88800	20400	29000	
	309L3	202	5.0	17000	9.7	71 ... 160	—	—	69100	88900	21100	29000	
	309L3	223	4.5	13200	6.8	71 ... 160	—	—	70100	90200	21800	29000	
	309L3	239	4.2	13300	6.4	71 ... 160	—	—	70800	91100	22300	29000	
	309L3	284	3.5	15800	6.4	71 ... 160	—	—	72500	93300	23600	29000	
	309L3	336	3.0	14000	4.8	71 ... 160	—	—	74300	95700	25000	29000	
	309L4	349	2.9	21300	7.2	71 ... 160	—	—	74700	96200	25300	29000	
	309L4	406	2.5	19100	5.6	71 ... 160	—	—	76300	98200	26600	29000	
	309L4	465	2.2	19500	5.0	71 ... 160	—	—	77800	100200	27900	29000	
	309L4	509	2.0	14400	3.3	71 ... 160	—	—	78900	101500	28700	29000	
	309L4	579	1.7	21400	4.4	71 ... 160	—	—	80300	103400	30000	29000	
	309L4	654	1.5	18200	3.3	71 ... 160	—	—	81700	105200	31200	29000	
	309L4	722	1.4	21500	3.5	71 ... 160	—	—	82900	106700	32300	29000	
	309L4	801	1.2	18300	2.7	71 ... 160	—	—	84100	108300	33400	29000	
	309L4	906	1.1	18400	2.4	71 ... 160	—	—	85600	110200	34800	29000	
	309L4	999	1.0	18300	2.2	71 ... 160	—	—	86800	111700	36000	29000	
	309L4	1149	0.87	17000	1.7	71 ... 160	—	—	88600	114000	36000	29000	
	309L4	1286	0.78	17000	1.6	71 ... 160	—	—	90000	115800	36000	29000	
	309L4	1380	0.72	17000	1.5	71 ... 160	—	—	90900	117000	36000	29000	
	309L4	1605	0.62	17000	1.3	71 ... 160	—	—	92900	119600	36000	29000	
	309L4	1723	0.58	17000	1.2	71 ... 160	—	—	93900	120800	36000	29000	
	309L4	2003	0.50	17000	1.0	71 ... 160	—	—	95900	123400	36000	29000	
	309L4	2423	0.41	17000	0.83	71 ... 160	—	—	98500	126800	36000	29000	
	500	309L1	3.43	146	9750	150	180 ... 250	—	—	30900	39700	6840	27900
		309L1	4.09	122	10000	132	180 ... 250	—	—	32600	41900	7250	29000
309L1		5.25	95	10600	109	180 ... 250	—	—	35100	45200	7880	29000	
309L1		6.23	80	10900	94	180 ... 250	—	—	36900	47500	8350	29000	
309L2		12.3	41	10600	48	132 ... 200	—	—	45400	58400	10500	27900	
309L2		14.7	34	12900	49	132 ... 200	—	—	47800	61500	11100	29000	
309L2		17.4	28.8	13500	43	132 ... 200	—	—	50300	64700	11800	29000	
309L2		21.8	22.9	13700	35	132 ... 200	—	—	53800	69200	12700	29000	
309L2		25.4	19.7	12800	28.2	132 ... 200	—	—	56300	72400	13300	29000	
309L2		28.0	17.9	14900	29.6	132 ... 200	—	—	58000	74600	13800	29000	
309L2		32.6	15.4	15200	26.0	132 ... 200	—	—	60700	78100	14500	29000	
309L2		38.6	12.9	12900	18.6	132 ... 200	—	—	63900	82200	15300	29000	
309L2		46.7	10.7	13000	15.4	132 ... 200	—	—	67600	87000	16300	29000	
309L3		51.3	9.8	17700	19.8	71 ... 160	—	—	69000	88800	16800	29000	
309L3		60.5	8.3	19300	18.3	71 ... 160	—	—	69000	88800	17800	29000	
309L3		74.1	6.7	20100	15.5	71 ... 160	—	—	69000	88800	19100	29000	
309L3		80.6	6.2	16700	11.9	71 ... 160	—	—	69000	88800	19600	29000	
309L3		93.0	5.4	17500	10.8	71 ... 160	—	—	69000	88800	20600	29000	
309L3		100	5.0	21300	12.2	71 ... 160	—	—	69000	88800	21100	29000	
309L3		113	4.4	17100	8.7	71 ... 160	—	—	70200	90400	21900	29000	
309L3		126	4.0	17500	8.0	71 ... 160	—	—	71300	91800	22700	29000	
309L3		139	3.6	17500	7.2	71 ... 160	—	—	72300	93100	23500	29000	
309L3		162	3.1	18400	6.5	71 ... 160	—	—	73900	95100	24700	29000	
309L3		183	2.7	14300	4.5	71 ... 160	—	—	75200	96800	25700	29000	
309L3		202	2.5	19100	5.4	71 ... 160	—	—	76300	98200	26600	29000	
309L3		223	2.2	14700	3.8	71 ... 160	—	—	77400	99600	27500	29000	
309L3		239	2.1	14900	3.6	71 ... 160	—	—	78200	100600	28200	29000	
309L3		284	1.8	15800	3.2	71 ... 160	—	—	80100	103100	29800	29000	

B

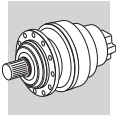



309 L



332

23240 Nm



n ₁ min ⁻¹		i	n ₂ min ⁻¹	M _{n2} Nm	P _{n1} kW	P (IEC) 	Rn ₂ [N]					M _{2 max} Nm
							MC	MZ	HC/PC	HZ/PZ	FZ	
500	309L3	336	1.5	15800	2.7	71 ... 160	—	—	82100	105600	31500	29000
	309L4	349	1.4	21500	3.6	71 ... 160	—	—	82500	106200	31900	29000
	309L4	406	1.2	21300	3.1	71 ... 160	—	—	84300	108500	33600	29000
	309L4	465	1.1	21700	2.8	71 ... 160	—	—	85900	110600	35100	29000
	309L4	509	0.98	14700	1.7	71 ... 160	—	—	87100	112000	36000	29000
	309L4	579	0.86	21600	2.2	71 ... 160	—	—	88700	114100	36000	29000
	309L4	654	0.77	18300	1.7	71 ... 160	—	—	90200	116100	36000	29000
	309L4	722	0.69	21600	1.8	71 ... 160	—	—	91500	117800	36000	29000
	309L4	801	0.62	18300	1.4	71 ... 160	—	—	92900	119500	36000	29000
	309L4	906	0.55	18500	1.2	71 ... 160	—	—	94500	121700	36000	29000
	309L4	999	0.50	18300	1.1	71 ... 160	—	—	95900	123400	36000	29000
	309L4	1149	0.44	17000	0.87	71 ... 160	—	—	97800	125900	36000	29000
	309L4	1286	0.39	17000	0.78	71 ... 160	—	—	99400	127900	36000	29000
	309L4	1380	0.36	17000	0.73	71 ... 160	—	—	100400	129200	36000	29000
	309L4	1605	0.31	17000	0.63	71 ... 160	—	—	102600	132000	36000	29000
	309L4	1723	0.29	17000	0.58	71 ... 160	—	—	103600	133400	36000	29000
	309L4	2003	0.25	17000	0.50	71 ... 160	—	—	105900	136300	36000	29000
	309L4	2423	0.21	17000	0.42	71 ... 160	—	—	108800	140000	36000	29000

310M L



344

33640 Nm

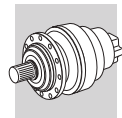

n ₁ min ⁻¹		i	n ₂ min ⁻¹	M _{n2} Nm	P _{n1} kW	P (IEC) 	Rn ₂ [N]					M _{2 max} Nm
							MC	MZ	HC/PC	HZ/PZ	FZ	
1500	310ML1	4.09	367	11700	175	200 ... 250	—	—	26500	33600	9080	47600
	310ML1	5.25	286	12300	175	200 ... 250	—	—	28500	36200	9870	47600
	310ML1	6.23	241	12800	175	200 ... 250	—	—	30000	38100	10400	47600
	310ML2	14.7	102	14900	75	160 ... 250	—	—	38900	49300	13900	47600
	310ML2	17.4	86	15400	75	160 ... 250	—	—	40900	51800	14700	47600
	310ML2	21.8	69	16100	75	160 ... 250	—	—	43700	55500	15900	47600
	310ML2	25.4	59	16700	75	160 ... 250	—	—	45800	58000	16700	47600
	310ML2	28	54	20300	75	160 ... 250	—	—	47100	59800	17200	47600
	310ML2	30.7	49	17100	75	160 ... 250	—	—	48500	61400	17800	47600
	310ML2	32.6	46	20800	75	160 ... 250	—	—	49300	62500	18100	47600
	310ML2	38.6	39	17800	75	160 ... 250	—	—	51900	65800	19200	47600
	310ML2	46.7	32	17800	64	160 ... 250	—	—	55000	69700	20500	47600
	310ML3	53	28.3	19100	40	132 ... 200	—	—	57100	72400	21300	47600
	310ML3	62.6	24.0	19800	40	132 ... 200	—	—	60000	76100	22500	47600
	310ML3	73.9	20.3	22300	40	132 ... 200	—	—	63100	80000	23800	47600
	310ML3	80.3	18.7	20600	40	132 ... 200	—	—	64700	82000	24500	47600
	310ML3	92.7	16.2	23200	40	132 ... 200	—	—	67500	85600	25700	47600
	310ML3	101	14.9	20800	36	132 ... 200	—	—	69200	87800	26400	47600
	310ML3	108	13.9	24300	39	132 ... 200	—	—	70600	89600	27000	47600
	310ML3	119	12.6	21500	31	132 ... 200	—	—	72800	92300	27900	47600
	310ML3	135	11.1	25800	33	132 ... 200	—	—	75600	95900	29100	47600
	310ML3	149	10.0	21700	25	132 ... 200	—	—	77900	98800	30100	47600
	310ML3	164	9.2	26600	27.9	132 ... 200	—	—	78000	98900	31100	47600
	310ML3	177	8.5	17900	17.3	132 ... 200	—	—	78000	98900	31900	47600
	310ML3	202	7.4	22100	18.8	132 ... 200	—	—	78000	98900	33300	47600
	310ML3	230	6.5	19300	14.5	132 ... 200	—	—	78000	98900	34800	47600
	310ML3	249	6.0	17900	12.4	132 ... 200	—	—	78000	98900	35700	47600
	310ML3	295	5.1	22700	13.2	132 ... 200	—	—	78000	98900	37800	47600
	310ML3	350	4.3	18500	9.1	132 ... 200	—	—	79800	101100	40000	47600
	310ML4	392	3.8	18900	8.5	71 ... 160	—	—	81000	102700	41500	47600
	310ML4	453	3.3	29000	11.3	71 ... 160	—	—	82700	104900	43600	47600
	310ML4	507	3.0	24900	8.7	71 ... 160	—	—	84100	106600	45300	47600
	310ML4	590	2.5	25600	7.7	71 ... 160	—	—	85900	108900	47600	47600
	310ML4	637	2.4	25900	7.2	71 ... 160	—	—	86900	110100	48800	47600
	310ML4	726	2.1	26500	6.5	71 ... 160	—	—	88500	112200	51000	47600



310M L



33640 Nm

n ₁ min ⁻¹		i	n ₂ min ⁻¹	M _{n2} Nm	P _{n1} kW	P (IEC) 	Rn ₂ [N]					M _{2 max} Nm
							MC	MZ	HC/PC	HZ/PZ	FZ	
1500	310ML4	798	1.9	27000	6.0	71 ... 160	—	—	89700	113700	52700	47600
	310ML4	974	1.5	32000	5.8	71 ... 160	—	—	92300	117000	56300	47600
	310ML4	1002	1.5	28100	5.0	71 ... 160	—	—	92700	117500	56800	47600
	310ML4	1164	1.3	28800	4.4	71 ... 160	—	—	94700	120000	59700	47600
	310ML4	1259	1.2	24800	3.5	71 ... 160	—	—	95700	121400	61300	47600
	310ML4	1438	1.0	23800	2.9	71 ... 160	—	—	97600	123700	64100	47600
	310ML4	1672	0.90	23900	2.5	71 ... 160	—	—	99700	126400	65000	47600
	310ML4	1794	0.84	23900	2.4	71 ... 160	—	—	100700	127700	65000	47600
	310ML4	2022	0.74	23900	2.1	71 ... 160	—	—	102400	129900	65000	47600
	310ML4	2523	0.59	23900	1.7	71 ... 160	—	—	105700	134100	65000	47600
1000	310ML1	4.09	244	13200	175	200 ... 250	—	—	29900	37900	10400	47600
	310ML1	5.25	190	13900	175	200 ... 250	—	—	32200	40900	11300	47600
	310ML1	6.23	160	14400	175	200 ... 250	—	—	33900	43000	12000	47600
	310ML2	14.7	68	16800	75	160 ... 250	—	—	43900	55700	15900	47600
	310ML2	17.4	58	17400	75	160 ... 250	—	—	46100	58500	16800	47600
	310ML2	21.8	46	18100	75	160 ... 250	—	—	49400	62600	18200	47600
	310ML2	25.4	39	18500	75	160 ... 250	—	—	51700	65500	19100	47600
	310ML2	28	36	20900	75	160 ... 250	—	—	53200	67500	19700	47600
	310ML2	30.7	33	17700	64	160 ... 250	—	—	54700	69400	20300	47600
	310ML2	32.6	31	21000	72	160 ... 250	—	—	55700	70600	20800	47600
	310ML2	38.6	25.9	17800	51	160 ... 250	—	—	58600	74300	22000	47600
	310ML2	46.7	21.4	17800	42	160 ... 250	—	—	62100	78700	23400	47600
	310ML3	53	18.9	21600	40	132 ... 200	—	—	64500	81800	24400	47600
	310ML3	62.6	16.0	22400	40	132 ... 200	—	—	67800	85900	25800	47600
	310ML3	73.9	13.5	24600	38	132 ... 200	—	—	71200	90300	27300	47600
	310ML3	80.3	12.4	21300	30	132 ... 200	—	—	73000	92600	28000	47600
	310ML3	92.7	10.8	25700	32	132 ... 200	—	—	76300	96700	29400	47600
	310ML3	101	9.9	21700	24.7	132 ... 200	—	—	78000	98900	30300	47600
	310ML3	108	9.3	26700	28.4	132 ... 200	—	—	78000	98900	30900	47600
	310ML3	119	8.4	21900	21.1	132 ... 200	—	—	78000	98900	32000	47600
	310ML3	135	7.4	27700	23.5	132 ... 200	—	—	78000	98900	33400	47600
	310ML3	149	6.7	22300	17.1	132 ... 200	—	—	78000	98900	34500	47600
	310ML3	164	6.1	27000	18.9	132 ... 200	—	—	78000	98900	35600	47600
	310ML3	177	5.6	18000	11.6	132 ... 200	—	—	78000	98900	36500	47600
	310ML3	202	5.0	22700	12.9	132 ... 200	—	—	78100	99000	38100	47600
	310ML3	230	4.3	19300	9.6	132 ... 200	—	—	79600	100900	39800	47600
	310ML3	249	4.0	18700	8.6	132 ... 200	—	—	80500	102100	40900	47600
	310ML3	295	3.4	23900	9.3	132 ... 200	—	—	82500	104600	43300	47600
	310ML3	350	2.9	19900	6.5	132 ... 200	—	—	84500	107200	45800	47600
	310ML4	392	2.6	20300	6.1	71 ... 160	—	—	85900	108900	47600	47600
	310ML4	453	2.2	29000	7.6	71 ... 160	—	—	87700	111200	49900	47600
	310ML4	507	2.0	26700	6.2	71 ... 160	—	—	89100	113000	51800	47600
	310ML4	590	1.7	27400	5.5	71 ... 160	—	—	91000	115400	54500	47600
	310ML4	637	1.6	27800	5.2	71 ... 160	—	—	92000	116700	55900	47600
	310ML4	726	1.4	28500	4.6	71 ... 160	—	—	93800	118900	58400	47600
	310ML4	798	1.3	28900	4.3	71 ... 160	—	—	95100	120500	60300	47600
	310ML4	974	1.0	33100	4.0	71 ... 160	—	—	97800	124000	64400	47600
	310ML4	1002	1.0	30100	3.6	71 ... 160	—	—	98200	124500	65000	47600
	310ML4	1164	0.86	30100	3.1	71 ... 160	—	—	100300	127200	65000	47600
	310ML4	1259	0.79	24800	2.3	71 ... 160	—	—	101400	128600	65000	47600
	310ML4	1438	0.70	23900	2.0	71 ... 160	—	—	103400	131100	65000	47600
	310ML4	1672	0.60	23900	1.7	71 ... 160	—	—	105600	133900	65000	47600
	310ML4	1794	0.56	23900	1.6	71 ... 160	—	—	106700	135300	65000	47600
	310ML4	2022	0.49	23900	1.4	71 ... 160	—	—	108600	137600	65000	47600
	310ML4	2523	0.40	23900	1.1	71 ... 160	—	—	112000	142100	65000	47600
500	310ML1	4.09	122	16200	175	200 ... 250	—	—	36800	46700	13100	47600
	310ML1	5.25	95	17100	175	200 ... 250	—	—	39700	50300	14200	47600
	310ML1	6.23	80	17000	147	200 ... 250	—	—	41800	53000	15100	47600
	310ML2	14.7	34	20100	75	160 ... 250	—	—	54100	68500	20100	47600

B

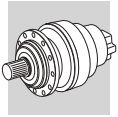

310M L

344

33640 Nm

n ₁ min ⁻¹		i	n ₂ min ⁻¹	M _{n2} Nm	P _{n1} kW	P (IEC)	Rn ₂ [N]					M _{2 max} Nm
							MC	MZ	HC/PC	HZ/PZ	FZ	
500	310ML2	17.4	28.8	20700	66	160 ... 250	—	—	56800	72000	21200	47600
	310ML2	21.8	22.9	21500	55	160 ... 250	—	—	60800	77100	22900	47600
	310ML2	25.4	19.7	21500	47	160 ... 250	—	—	63600	80700	24100	47600
	310ML2	28	17.9	21300	42	160 ... 250	—	—	65500	83100	24900	47600
	310ML2	30.7	16.3	18600	34	160 ... 250	—	—	67400	85400	25600	47600
	310ML2	32.6	15.4	21400	37	160 ... 250	—	—	68600	87000	26100	47600
	310ML2	38.6	12.9	17800	25.7	160 ... 250	—	—	72200	91500	27700	47600
	310ML2	46.7	10.7	17800	21.2	160 ... 250	—	—	76400	96900	29500	47600
	310ML3	53	9.4	26400	28.6	132 ... 200	—	—	78000	98900	30800	47600
	310ML3	62.6	8.0	26900	24.6	132 ... 200	—	—	78000	98900	32500	47600
	310ML3	73.9	6.8	28100	21.8	132 ... 200	—	—	78000	98900	34400	47600
	310ML3	80.3	6.2	22400	16.0	132 ... 200	—	—	78000	98900	35300	47600
	310ML3	92.7	5.4	29000	17.9	132 ... 200	—	—	78000	98900	37100	47600
	310ML3	101	5.0	22700	12.9	132 ... 200	—	—	78100	99000	38100	47600
	310ML3	108	4.6	28100	14.9	132 ... 200	—	—	78800	100000	39000	47600
	310ML3	119	4.2	23400	11.3	132 ... 200	—	—	80000	101400	40300	47600
	310ML3	135	3.7	29900	12.7	132 ... 200	—	—	81400	103300	42000	47600
	310ML3	149	3.3	24400	9.4	132 ... 200	—	—	82600	104700	43400	47600
	310ML3	164	3.1	27200	9.5	132 ... 200	—	—	83700	106100	44800	47600
	310ML3	177	2.8	19900	6.4	132 ... 200	—	—	84600	107300	46000	47600
	310ML3	202	2.5	25700	7.3	132 ... 200	—	—	86200	109300	48000	47600
	310ML3	230	2.2	19400	4.8	132 ... 200	—	—	87900	111400	50200	47600
	310ML3	249	2.0	21200	4.9	132 ... 200	—	—	88900	112700	51500	47600
	310ML3	295	1.7	24800	4.8	132 ... 200	—	—	91000	115400	54500	47600
	310ML3	350	1.4	22500	3.7	132 ... 200	—	—	93300	118300	57700	47600
	310ML4	392	1.3	22900	3.5	71 ... 160	—	—	94800	120200	59900	47600
	310ML4	453	1.1	29000	3.8	71 ... 160	—	—	96800	122700	62900	47600
	310ML4	507	0.99	30100	3.5	71 ... 160	—	—	98400	124700	65000	47600
	310ML4	590	0.85	30100	3.0	71 ... 160	—	—	100500	127400	65000	47600
	310ML4	637	0.79	30100	2.8	71 ... 160	—	—	101600	128800	65000	47600
	310ML4	726	0.69	30100	2.5	71 ... 160	—	—	103500	131300	65000	47600
	310ML4	798	0.63	30100	2.2	71 ... 160	—	—	104900	133100	65000	47600
	310ML4	974	0.51	33200	2.0	71 ... 160	—	—	108000	136900	65000	47600
	310ML4	1002	0.50	30100	1.8	71 ... 160	—	—	108400	137500	65000	47600
	310ML4	1164	0.43	30100	1.5	71 ... 160	—	—	110800	140400	65000	47600
	310ML4	1259	0.40	24800	1.2	71 ... 160	—	—	112000	142000	65000	47600
	310ML4	1438	0.35	23900	0.98	71 ... 160	—	—	114200	144700	65000	47600
	310ML4	1672	0.30	23900	0.85	71 ... 160	—	—	116600	147900	65000	47600
	310ML4	1794	0.28	23900	0.79	71 ... 160	—	—	117800	149400	65000	47600
	310ML4	2022	0.25	23900	0.70	71 ... 160	—	—	119800	152000	65000	47600
	310ML4	2523	0.20	23900	0.56	71 ... 160	—	—	123700	156800	65000	47600

311M L

356

49210 Nm

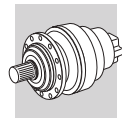

n ₁ min ⁻¹		i	n ₂ min ⁻¹	M _{n2} Nm	P _{n1} kW	P (IEC)	Rn ₂ [N]					M _{2 max} Nm
							MC	MZ	HC/PC	HZ/PZ	FZ	
1500	311ML1	4.09	367	16600	200	200 ... 250	—	—	33300	42400	9080	58300
	311ML1	5.25	286	17500	200	200 ... 250	—	—	35800	45700	9870	58300
	311ML1	6.23	241	18200	200	200 ... 250	—	—	37700	48100	10400	58300
	311ML2	14.0	107	20300	115	180 ... 250	—	—	48100	61400	13700	58300
	311ML2	16.7	90	20900	115	180 ... 250	—	—	50800	64700	14500	58300
	311ML2	18.0	83	25300	115	180 ... 250	—	—	51900	66200	14900	58300
	311ML2	21.5	70	20800	115	180 ... 250	—	—	54700	69800	15800	58300
	311ML2	25.5	59	22800	115	180 ... 250	—	—	57600	73400	16700	58300
	311ML2	27.6	54	28200	115	180 ... 250	—	—	59000	75200	17200	58300
	311ML2	32.7	46	28900	115	180 ... 250	—	—	62100	79200	18200	58300
	311ML2	38.8	39	27200	115	180 ... 250	—	—	65300	83300	19200	58300
	311ML3	50.5	29.7	27600	60	132 ... 200	—	—	70700	90200	21000	58300



311M L



49210 Nm

n ₁ min ⁻¹		i	n ₂ min ⁻¹	M _{n2} Nm	P _{n1} kW	P (IEC) 	Rn ₂ [N]					M _{2 max} Nm	
							MC	MZ	HC/PC	HZ/PZ	FZ		
1500	311ML3	60.2	24.9	30700	60	132 ... 200	—	—	74500	95100	22300	58300	
	311ML3	71.1	21.1	32200	60	132 ... 200	—	—	78300	99900	23500	58300	
	311ML3	77.3	19.4	32600	60	132 ... 200	—	—	80300	100000	24200	58300	
	311ML3	89.3	16.8	34500	60	132 ... 200	—	—	83900	100000	25400	58300	
	311ML3	104	14.5	36100	60	132 ... 200	—	—	87700	100000	26700	58300	
	311ML3	115	13.1	34000	51	132 ... 200	—	—	90400	100000	27600	58300	
	311ML3	133	11.3	34600	45	132 ... 200	—	—	94600	100000	29000	58300	
	311ML3	147	10.2	34900	41	132 ... 200	—	—	97400	100000	30000	58300	
	311ML3	161	9.3	35200	38	132 ... 200	—	—	98000	100000	30900	58300	
	311ML3	171	8.8	35300	36	132 ... 200	—	—	98000	100000	31500	58300	
	311ML3	191	7.8	32000	28.8	132 ... 200	—	—	98000	100000	32700	58300	
	311ML3	203	7.4	35700	30	132 ... 200	—	—	98000	100000	33400	58300	
	311ML3	245	6.1	36200	25.4	132 ... 200	—	—	98000	100000	35500	58300	
	311ML3	291	5.2	27500	16.2	132 ... 200	—	—	98000	100000	37600	58300	
	311ML4	348	4.3	45700	23.3	71 ... 160	—	—	100100	102100	39900	58300	
	311ML4	410	3.7	46000	19.9	71 ... 160	—	—	102500	104600	42200	58300	
	311ML4	512	2.9	46300	16.0	71 ... 160	—	—	105800	107900	45400	58300	
	311ML4	568	2.6	41000	12.8	71 ... 160	—	—	107300	109500	47000	58300	
	311ML4	627	2.4	41700	11.8	71 ... 160	—	—	108900	111100	48600	58300	
	311ML4	825	1.8	43500	9.4	71 ... 160	—	—	113200	115500	53300	58300	
	311ML4	986	1.5	44800	8.1	71 ... 160	—	—	116200	118500	56500	58300	
	311ML4	1058	1.4	45300	7.6	71 ... 160	—	—	117300	119700	57900	58300	
	311ML4	1230	1.2	46300	6.7	71 ... 160	—	—	119900	122300	60800	58300	
	311ML4	1415	1.1	41200	5.2	71 ... 160	—	—	122300	124800	63800	58300	
	311ML4	1680	0.89	36500	3.9	71 ... 160	—	—	125300	127900	65000	58300	
	311ML4	1766	0.85	41300	4.1	71 ... 160	—	—	126200	128800	65000	58300	
	311ML4	2096	0.72	36500	3.1	71 ... 160	—	—	129400	132000	65000	58300	
	1000	311ML1	4.09	244	18800	200	200 ... 250	—	—	37600	47900	10400	58300
		311ML1	5.25	190	19700	200	200 ... 250	—	—	40500	51600	11300	58300
		311ML1	6.23	160	20500	200	200 ... 250	—	—	42600	54400	12000	58300
		311ML2	14.0	71	22900	115	180 ... 250	—	—	54400	69300	15700	58300
		311ML2	16.7	60	23600	115	180 ... 250	—	—	57300	73100	16600	58300
311ML2		18.0	56	28600	115	180 ... 250	—	—	58600	74700	17000	58300	
311ML2		21.5	47	23500	115	180 ... 250	—	—	61800	78800	18100	58300	
311ML2		25.5	39	25100	109	180 ... 250	—	—	65000	83000	19100	58300	
311ML2		27.6	36	30100	115	180 ... 250	—	—	66600	84900	19600	58300	
311ML2		32.7	31	30400	103	180 ... 250	—	—	70100	89400	20800	58300	
311ML2		38.8	25.8	27200	78	180 ... 250	—	—	73800	94100	22000	58300	
311ML3		50.5	19.8	29300	60	132 ... 200	—	—	79800	100000	24000	58300	
311ML3		60.2	16.6	34600	60	132 ... 200	—	—	84200	100000	25500	58300	
311ML3		71.1	14.1	36400	59	132 ... 200	—	—	88500	100000	26900	58300	
311ML3		77.3	12.9	34100	51	132 ... 200	—	—	90700	100000	27700	58300	
311ML3		89.3	11.2	39000	50	132 ... 200	—	—	94700	100000	29000	58300	
311ML3		104	9.6	40600	45	132 ... 200	—	—	98000	100000	30500	58300	
311ML3		115	8.7	35300	35	132 ... 200	—	—	98000	100000	31600	58300	
311ML3		133	7.5	35700	31	132 ... 200	—	—	98000	100000	33200	58300	
311ML3		147	6.8	35900	28.0	132 ... 200	—	—	98000	100000	34300	58300	
311ML3		161	6.2	36200	25.8	132 ... 200	—	—	98000	100000	35400	58300	
311ML3		171	5.9	36300	24.4	132 ... 200	—	—	98000	100000	36100	58300	
311ML3		191	5.2	32000	19.2	132 ... 200	—	—	98000	100000	37400	58300	
311ML3		203	4.9	36800	20.8	132 ... 200	—	—	98200	100200	38200	58300	
311ML3		245	4.1	38000	17.8	132 ... 200	—	—	100900	103000	40700	58300	
311ML3		291	3.4	29400	11.6	132 ... 200	—	—	103400	105500	43100	58300	
311ML4		348	2.9	46400	15.8	71 ... 160	—	—	106100	108200	45700	58300	
311ML4		410	2.4	46700	13.4	71 ... 160	—	—	108600	110800	48300	58300	

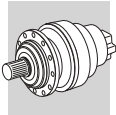

B



311M L



49210 Nm

n ₁ min ⁻¹		i	n ₂ min ⁻¹	M _{n2} Nm	P _{n1} kW	P (IEC) 	Rn ₂ [N]					M _{2 max} Nm
							MC	MZ	HC/PC	HZ/PZ	FZ	
1000	311ML4	512	2	47300	10.9	71 ... 160	—	—	112100	114400	52000	58300
	311ML4	568	1.8	43700	9.1	71 ... 160	—	—	113700	116100	53800	58300
	311ML4	627	1.6	44400	8.4	71 ... 160	—	—	115400	117700	55600	58300
	311ML4	825	1.2	46400	6.7	71 ... 160	—	—	120000	122400	61000	58300
	311ML4	986	1	47700	5.7	71 ... 160	—	—	123100	125600	64700	58300
	311ML4	1058	0.94	47800	5.3	71 ... 160	—	—	124300	126900	65000	58300
	311ML4	1230	0.81	47800	4.6	71 ... 160	—	—	127000	129600	65000	58300
	311ML4	1415	0.71	41300	3.4	71 ... 160	—	—	129600	132300	65000	58300
	311ML4	1680	0.6	36500	2.6	71 ... 160	—	—	132800	135500	65000	58300
	311ML4	1766	0.57	41300	2.8	71 ... 160	—	—	133800	136500	65000	58300
311ML4	2096	0.48	36500	2.1	71 ... 160	—	—	137100	139900	65000	58300	
500	311ML1	4.09	122	23100	200	200 ... 250	—	—	46200	59000	13100	58300
	311ML1	5.25	95	24300	200	200 ... 250	—	—	49800	63600	14200	58300
	311ML1	6.23	80	24700	200	200 ... 250	—	—	52500	66900	15100	58300
	311ML2	14.0	36	26800	106	180 ... 250	—	—	66900	85400	19800	58300
	311ML2	16.7	29.9	29000	97	180 ... 250	—	—	70600	90000	20900	58300
	311ML2	18.0	27.8	31400	97	180 ... 250	—	—	72100	92000	21500	58300
	311ML2	21.5	23.3	28100	73	180 ... 250	—	—	76100	97000	22800	58300
	311ML2	25.5	19.6	28400	62	180 ... 250	—	—	80100	100000	24100	58300
	311ML2	27.6	18.1	32600	66	180 ... 250	—	—	82000	100000	24700	58300
	311ML2	32.7	15.3	33200	56	180 ... 250	—	—	86300	100000	26200	58300
	311ML2	38.8	12.9	27200	39	180 ... 250	—	—	90800	100000	27700	58300
	311ML3	50.5	9.9	32400	37	132 ... 200	—	—	98000	100000	30300	58300
	311ML3	60.2	8.3	41600	40	132 ... 200	—	—	98000	100000	32100	58300
	311ML3	71.1	7.0	42800	35	132 ... 200	—	—	98000	100000	33900	58300
	311ML3	77.3	6.5	36100	26.8	132 ... 200	—	—	98000	100000	34900	58300
	311ML3	89.3	5.6	44600	28.6	132 ... 200	—	—	98000	100000	36600	58300
	311ML3	104	4.8	45500	25.2	132 ... 200	—	—	98500	100500	38500	58300
	311ML3	115	4.4	37600	18.8	132 ... 200	—	—	99900	102000	39800	58300
	311ML3	133	3.8	38600	16.6	132 ... 200	—	—	102100	104200	41800	58300
	311ML3	147	3.4	39200	15.3	132 ... 200	—	—	103500	105700	43200	58300
	311ML3	161	3.1	39900	14.2	132 ... 200	—	—	104900	107000	44600	58300
	311ML3	171	2.9	40300	13.5	132 ... 200	—	—	105800	108000	45400	58300
	311ML3	191	2.6	32000	9.6	132 ... 200	—	—	107500	109700	47200	58300
	311ML3	203	2.5	41200	11.6	132 ... 200	—	—	108400	110600	48100	58300
	311ML3	245	2.0	41200	9.6	132 ... 200	—	—	111400	113700	51300	58300
	311ML3	291	1.7	33200	6.5	132 ... 200	—	—	114200	116500	54300	58300
	311ML4	348	1.4	48200	8.2	71 ... 160	—	—	117100	119500	57600	58300
	311ML4	410	1.2	48600	7.0	71 ... 160	—	—	119900	122300	60900	58300
	311ML4	512	0.98	49200	5.7	71 ... 160	—	—	123800	126300	65000	58300
	311ML4	568	0.88	47800	5.0	71 ... 160	—	—	125600	128200	65000	58300
	311ML4	627	0.80	47800	4.5	71 ... 160	—	—	127400	130000	65000	58300
	311ML4	825	0.61	47800	3.4	71 ... 160	—	—	132500	135200	65000	58300
	311ML4	986	0.51	47800	2.9	71 ... 160	—	—	135900	138700	65000	58300
	311ML4	1058	0.47	47800	2.7	71 ... 160	—	—	137300	140100	65000	58300
	311ML4	1230	0.41	47800	2.3	71 ... 160	—	—	140300	143100	65000	58300
	311ML4	1415	0.35	41300	1.7	71 ... 160	—	—	143100	146000	65000	58300
	311ML4	1680	0.30	36500	1.3	71 ... 160	—	—	146600	149600	65000	58300
	311ML4	1766	0.28	41300	1.4	71 ... 160	—	—	147700	150700	65000	58300
	311ML4	2096	0.24	36500	1.0	71 ... 160	—	—	151400	154400	65000	58300

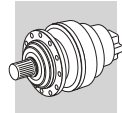

B



313M L



60940 Nm

n ₁ min ⁻¹		i	n ₂ min ⁻¹	M _{n2} Nm	P _{n1} kW	P (IEC) 	Rn ₂ [N]					M _{2 max} Nm	
							MC	MZ	HC/PC	HZ/PZ	FZ		
1500	313ML2	14.2	106	28200	150	180 ... 250	—	—	70000	82000	16900	105000	
	313ML2	16.9	89	29000	150	180 ... 250	—	—	73800	86500	18000	105000	
	313ML2	18.5	81	35600	150	180 ... 250	—	—	75800	88800	18500	105000	
	313ML2	21.8	69	30500	150	180 ... 250	—	—	79600	93200	19500	105000	
	313ML2	25.8	58	31700	150	180 ... 250	—	—	83800	98100	20700	105000	
	313ML2	28.4	53	39800	150	180 ... 250	—	—	86100	100900	21300	105000	
	313ML2	33.6	45	40100	150	180 ... 250	—	—	90700	106300	22600	105000	
	313ML2	40.5	37	30200	124	180 ... 250	—	—	95900	112300	24000	105000	
	313ML3	51.1	29.3	31700	60	132 ... 200	—	—	102800	120500	25900	105000	
	313ML3	61.0	24.6	37800	60	132 ... 200	—	—	108400	127000	27500	105000	
	313ML3	72.0	20.8	39100	60	132 ... 200	—	—	113900	133500	29100	105000	
	313ML3	78.3	19.2	42800	60	132 ... 200	—	—	116800	136900	29900	105000	
	313ML3	92.4	16.2	44600	60	132 ... 200	—	—	122800	143900	31600	105000	
	313ML3	110	13.7	45200	60	132 ... 200	—	—	129300	151500	33500	105000	
	313ML3	120	12.4	41300	59	132 ... 200	—	—	133000	155800	34500	105000	
	313ML3	135	11.1	49100	60	132 ... 200	—	—	137500	161200	35800	105000	
	313ML3	143	10.5	41400	50	132 ... 200	—	—	140000	164000	36500	105000	
	313ML3	151	9.9	41400	47	132 ... 200	—	—	142000	166400	37200	105000	
	313ML3	163	9.2	50800	54	132 ... 200	—	—	142000	166400	38200	105000	
	313ML3	176	8.5	41800	41	132 ... 200	—	—	142000	166400	39100	105000	
	313ML3	182	8.2	30200	28.6	132 ... 200	—	—	142000	166400	39600	105000	
	313ML3	194	7.7	48600	43	132 ... 200	—	—	142000	166400	40400	105000	
	313ML3	209	7.2	42200	35	132 ... 200	—	—	142000	166400	41400	105000	
	313ML3	252	5.9	42700	29.1	132 ... 200	—	—	142000	166400	44200	105000	
	313ML3	304	4.9	30300	17.2	132 ... 200	—	—	142300	166700	47000	105000	
	313ML4	394	3.8	56400	25.4	71 ... 160	—	—	147600	173000	51200	105000	
	313ML4	452	3.3	56800	22.3	71 ... 160	—	—	150600	176400	53600	105000	
	313ML4	514	2.9	47400	16.4	71 ... 160	—	—	153300	179700	56000	105000	
	313ML4	564	2.7	54200	17.1	71 ... 160	—	—	155400	182100	57700	105000	
	313ML4	633	2.4	48800	13.7	71 ... 160	—	—	158000	185100	60000	105000	
	313ML4	695	2.2	50000	12.8	71 ... 160	—	—	160100	187600	61900	105000	
	313ML4	790	1.9	49300	11.1	71 ... 160	—	—	163100	191100	64600	105000	
	313ML4	889	1.7	52200	10.4	71 ... 160	—	—	165800	194300	67200	105000	
	313ML4	1014	1.5	53400	9.3	71 ... 160	—	—	169000	198000	70200	105000	
	313ML4	1117	1.3	50100	8.0	71 ... 160	—	—	171300	200800	72500	105000	
	313ML4	1266	1.2	55500	7.8	71 ... 160	—	—	174400	204400	75600	105000	
	313ML4	1394	1.1	50600	6.4	71 ... 160	—	—	176800	207200	78100	105000	
	313ML4	1502	1.0	57100	6.7	71 ... 160	—	—	178700	209500	80000	105000	
	313ML4	1817	0.83	57100	5.6	71 ... 160	—	—	183700	215200	80000	105000	
	313ML4	2187	0.69	40100	3.3	71 ... 160	—	—	188600	221000	80000	105000	
	1000	313ML1	4.14	241	26300	250	—	—	—	54600	64000	12800	105000
		313ML1	5.40	185	27700	250	—	—	—	59200	69300	14000	105000
		313ML1	6.50	154	26500	250	—	—	—	62500	73300	14900	105000
		313ML2	14.2	70	31800	150	180 ... 250	—	—	79100	92700	19400	105000
		313ML2	16.9	59	32800	150	180 ... 250	—	—	83400	97700	20500	105000
		313ML2	18.5	54	40200	150	180 ... 250	—	—	85600	100300	21200	105000
		313ML2	21.8	46	34300	150	180 ... 250	—	—	89900	105300	22300	105000
		313ML2	25.8	39	35300	150	180 ... 250	—	—	94600	110800	23600	105000
		313ML2	28.4	35	40700	150	180 ... 250	—	—	97300	114000	24400	105000
		313ML2	33.6	29.7	40400	134	180 ... 250	—	—	102400	120000	25800	105000
313ML2		40.5	24.7	30200	83	180 ... 250	—	—	108300	126900	27500	105000	
313ML3		51.1	19.6	35800	60	132 ... 200	—	—	116100	136100	29700	105000	
313ML3		61.0	16.4	42700	60	132 ... 200	—	—	122400	143500	31500	105000	
313ML3		72.0	13.9	44200	60	132 ... 200	—	—	128700	150800	33300	105000	
313ML3		78.3	12.8	47400	60	132 ... 200	—	—	132000	154600	34200	105000	
313ML3		92.4	10.8	49400	60	132 ... 200	—	—	138700	162500	36200	105000	
313ML3		110	9.1	48600	51	132 ... 200	—	—	142000	166400	38300	105000	
313ML3		120	8.3	41900	40	132 ... 200	—	—	142000	166400	39500	105000	
313ML3		135	7.4	52600	45	132 ... 200	—	—	142000	166400	41000	105000	
313ML3		143	7.0	42300	34	132 ... 200	—	—	142000	166400	41800	105000	
313ML3		151	6.6	42400	32	132 ... 200	—	—	142000	166400	42600	105000	



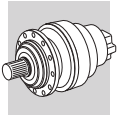



313M L



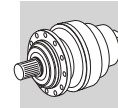

60940 Nm

n ₁ min ⁻¹		i	n ₂ min ⁻¹	M _{n2} Nm	P _{n1} kW	P (IEC) 	Rn ₂ [N]					M _{2 max} Nm	
							MC	MZ	HC/PC	HZ/PZ	FZ		
1000	313ML3	163	6.1	53000	37	132 ... 200	—	—	142000	166400	43700	105000	
	313ML3	176	5.7	42800	28.0	132 ... 200	—	—	142000	166400	44800	105000	
	313ML3	182	5.5	30300	19.1	132 ... 200	—	—	142000	166400	45300	105000	
	313ML3	194	5.2	48600	28.8	132 ... 200	—	—	142000	166400	46300	105000	
	313ML3	209	4.8	43500	23.9	132 ... 200	—	—	142900	167400	47400	105000	
	313ML3	252	4.0	44900	20.4	132 ... 200	—	—	146800	172000	50600	105000	
	313ML3	304	3.3	32600	12.3	132 ... 200	—	—	150700	176600	53800	105000	
	313ML4	394	2.5	57600	17.3	71 ... 160	—	—	156400	183300	58700	105000	
	313ML4	452	2.2	58100	15.2	71 ... 160	—	—	159500	186900	61400	105000	
	313ML4	514	1.9	50900	11.7	71 ... 160	—	—	162500	190400	64100	105000	
	313ML4	564	1.8	54200	11.4	71 ... 160	—	—	164700	193000	66100	105000	
	313ML4	633	1.6	49700	9.3	71 ... 160	—	—	167400	196200	68700	105000	
	313ML4	695	1.4	53600	9.1	71 ... 160	—	—	169700	198800	70900	105000	
	313ML4	790	1.3	50200	7.5	71 ... 160	—	—	172800	202500	74000	105000	
	313ML4	889	1.1	56000	7.4	71 ... 160	—	—	175700	205900	76900	105000	
	313ML4	1014	0.99	57100	6.7	71 ... 160	—	—	179100	209800	80000	105000	
	313ML4	1117	0.9	50800	5.4	71 ... 160	—	—	181600	212700	80000	105000	
	313ML4	1266	0.79	57100	5.3	71 ... 160	—	—	184800	216600	80000	105000	
	313ML4	1394	0.72	50800	4.3	71 ... 160	—	—	187400	219600	80000	105000	
	313ML4	1502	0.67	57100	4.5	71 ... 160	—	—	189400	221900	80000	105000	
	313ML4	1817	0.55	57100	3.7	71 ... 160	—	—	192000	228100	80000	105000	
	313ML4	2187	0.46	40100	2.2	71 ... 160	—	—	192000	231000	80000	105000	
	500	313ML1	4.14	121	32400	250	—	—	—	67300	78800	16200	105000
		313ML1	5.40	93	34200	250	—	—	—	72800	85300	17700	105000
		313ML1	6.50	77	30200	250	—	—	—	77000	90200	18800	105000
		313ML2	14.2	35	37800	148	180 ... 250	—	—	97300	114100	24400	105000
		313ML2	16.9	29.5	39000	128	180 ... 250	—	—	102600	120300	25900	105000
		313ML2	18.5	27.0	41200	124	180 ... 250	—	—	105400	123500	26700	105000
		313ML2	21.8	23.0	40900	105	180 ... 250	—	—	110600	129600	28100	105000
		313ML2	25.8	19.4	41600	90	180 ... 250	—	—	116500	136500	29800	105000
		313ML2	28.4	17.6	41100	81	180 ... 250	—	—	119800	140400	30700	105000
		313ML2	33.6	14.9	41100	68	180 ... 250	—	—	126100	147800	32500	105000
		313ML2	40.5	12.3	30200	41	180 ... 250	—	—	133300	156200	34600	105000
313ML3		51.1	9.8	43900	49	132 ... 200	—	—	142000	166400	37400	105000	
313ML3		61.0	8.2	51200	48	132 ... 200	—	—	142000	166400	39700	105000	
313ML3		72.0	6.9	52300	42	132 ... 200	—	—	142000	166400	41900	105000	
313ML3		78.3	6.4	53700	39	132 ... 200	—	—	142000	166400	43100	105000	
313ML3		92.4	5.4	55000	34	132 ... 200	—	—	142000	166400	45600	105000	
313ML3		110	4.6	48600	25.4	132 ... 200	—	—	143900	168600	48300	105000	
313ML3		120	4.1	44600	21.2	132 ... 200	—	—	145800	170900	49800	105000	
313ML3		135	3.7	56500	24.0	132 ... 200	—	—	148200	173700	51700	105000	
313ML3		143	3.5	45900	18.4	132 ... 200	—	—	149400	175100	52700	105000	
313ML3		151	3.3	46400	17.6	132 ... 200	—	—	150600	176500	53700	105000	
313ML3		163	3.1	54100	19.0	132 ... 200	—	—	152300	178400	55100	105000	
313ML3		176	2.8	47600	15.5	132 ... 200	—	—	153900	180400	56500	105000	
313ML3		182	2.7	33600	10.6	132 ... 200	—	—	154700	181300	57100	105000	
313ML3		194	2.6	48600	14.4	132 ... 200	—	—	156100	182900	58300	105000	
313ML3		209	2.4	49000	13.5	132 ... 200	—	—	157700	184800	59800	105000	
313ML3		252	2.0	50700	11.5	132 ... 200	—	—	162100	189900	63700	105000	
313ML3		304	1.6	36800	6.9	132 ... 200	—	—	166400	195000	67800	105000	
313ML4		394	1.3	60100	9.0	71 ... 160	—	—	172700	202400	73900	105000	
313ML4		452	1.1	60600	7.9	71 ... 160	—	—	176100	206400	77300	105000	
313ML4		514	0.97	57100	6.6	71 ... 160	—	—	179400	210200	80000	105000	
313ML4		564	0.89	54200	5.7	71 ... 160	—	—	181800	213000	80000	105000	
313ML4		633	0.79	50800	4.7	71 ... 160	—	—	184800	216600	80000	105000	
313ML4		695	0.72	57100	4.9	71 ... 160	—	—	187300	219500	80000	105000	
313ML4		790	0.63	50800	3.8	71 ... 160	—	—	190800	223600	80000	105000	
313ML4		889	0.56	57100	3.8	71 ... 160	—	—	192000	227400	80000	105000	
313ML4		1014	0.49	57100	3.3	71 ... 160	—	—	192000	231000	80000	105000	
313ML4		1117	0.45	50800	2.7	71 ... 160	—	—	192000	231000	80000	105000	
313ML4		1266	0.40	57100	2.7	71 ... 160	—	—	192000	231000	80000	105000	





313M L 368

60940 Nm

n ₁ min ⁻¹		i	n ₂ min ⁻¹	M _{n2} Nm	P _{n1} kW	P (IEC) 	Rn ₂ [N]					M ₂ max Nm
							MC	MZ	HC/PC	HZ/PZ	FZ	
500	313ML4	1394	0.36	50800	2.2	71 ... 160	—	—	192000	231000	80000	105000
	313ML4	1502	0.33	57100	2.2	71 ... 160	—	—	192000	231000	80000	105000
	313ML4	1817	0.28	57100	1.9	71 ... 160	—	—	192000	231000	80000	105000
	313ML4	2187	0.23	40100	1.1	71 ... 160	—	—	192000	231000	80000	105000

314M L 380

80640 Nm

n ₁ min ⁻¹		i	n ₂ min ⁻¹	M _{n2} Nm	P _{n1} kW	P (IEC) 	Rn ₂ [N]					M ₂ max Nm	
							MC	MZ	HC/PC	HZ/PZ	FZ		
1500	314ML2	17.4	86	38500	175	200 ... 250	—	—	69200	82900	20400	115000	
	314ML2	22.3	67	40500	175	200 ... 250	—	—	74500	89400	22100	115000	
	314ML2	26.5	57	42100	175	200 ... 250	—	—	78500	94100	23400	115000	
	314ML2	28.0	54	50800	175	200 ... 250	—	—	79800	95700	23900	115000	
	314ML2	33.2	45	51700	175	200 ... 250	—	—	84000	100700	25300	115000	
	314ML2	38.6	39	47400	175	200 ... 250	—	—	87900	105400	26600	115000	
	314ML3	62.6	24.0	49200	75	160 ... 250	—	—	101600	121800	31200	115000	
	314ML3	73.9	20.3	50900	75	160 ... 250	—	—	106700	128000	33000	115000	
	314ML3	92.7	16.2	53100	75	160 ... 250	—	—	114300	137000	35600	115000	
	314ML3	108	13.9	55000	75	160 ... 250	—	—	119500	143400	37400	115000	
	314ML3	138	10.8	69500	75	160 ... 250	—	—	128800	154500	40700	115000	
	314ML3	164	9.1	59500	62	160 ... 250	—	—	132000	158300	43100	115000	
	314ML3	174	8.6	60200	60	160 ... 250	—	—	132000	158300	43900	115000	
	314ML3	206	7.3	60900	51	160 ... 250	—	—	132000	158300	46400	115000	
	314ML3	240	6.3	47800	34	160 ... 250	—	—	132000	158300	48800	115000	
	314ML4	314	4.8	75700	40	132 ... 200	—	—	132900	159300	53400	115000	
	314ML4	394	3.8	74700	34	132 ... 200	—	—	137200	164600	57600	115000	
	314ML4	458	3.3	74800	29.0	132 ... 200	—	—	140200	168200	60600	115000	
	314ML4	495	3.0	75600	27.1	132 ... 200	—	—	141800	170000	62200	115000	
	314ML4	575	2.6	67200	20.7	132 ... 200	—	—	144900	173700	65400	115000	
	314ML4	588	2.6	72400	21.9	132 ... 200	—	—	145300	174300	65900	115000	
	314ML4	668	2.2	76300	20.2	132 ... 200	—	—	148000	177500	68700	115000	
	314ML4	738	2.0	73700	17.7	132 ... 200	—	—	150100	180000	71000	115000	
	314ML4	858	1.7	74600	15.4	132 ... 200	—	—	153400	183900	74700	115000	
	314ML4	926	1.6	70200	13.4	132 ... 200	—	—	155100	186000	76600	115000	
	314ML4	1038	1.4	75700	12.9	132 ... 200	—	—	157600	189000	79600	115000	
	314ML4	1099	1.4	71300	11.5	132 ... 200	—	—	158900	190600	81100	115000	
	314ML4	1277	1.2	72300	10.0	132 ... 200	—	—	162400	194700	85300	115000	
	314ML4	1485	1.0	63100	7.5	132 ... 200	—	—	165900	198900	89700	115000	
	314ML4	1796	0.84	63300	6.2	132 ... 200	—	—	170500	204400	90000	115000	
	1000	314ML2	17.4	58	43400	175	200 ... 250	—	—	78100	93700	23300	115000
		314ML2	22.3	45	45700	175	200 ... 250	—	—	84200	100900	25300	115000
		314ML2	26.5	38	46100	175	200 ... 250	—	—	88600	106300	26800	115000
		314ML2	28.0	36	53400	175	200 ... 250	—	—	90100	108100	27300	115000
		314ML2	33.2	30	53800	175	200 ... 250	—	—	94800	113700	28900	115000
314ML2		38.6	25.9	47400	137	200 ... 250	—	—	99200	119000	30400	115000	
314ML3		62.6	16.0	55600	75	160 ... 250	—	—	114700	137500	35700	115000	
314ML3		73.9	13.5	57500	75	160 ... 250	—	—	120500	144600	37800	115000	
314ML3		92.7	10.8	59900	74	160 ... 250	—	—	129000	154800	40700	115000	
314ML3		108	9.3	62100	66	160 ... 250	—	—	132000	158300	42800	115000	
314ML3		138	7.2	71700	59	160 ... 250	—	—	132000	158300	46500	115000	
314ML3		164	6.1	59500	42	160 ... 250	—	—	132000	158300	49300	115000	
314ML3		174	5.8	61800	41	160 ... 250	—	—	132000	158300	50200	115000	
314ML3		206	4.9	62500	35	160 ... 250	—	—	132600	159000	53200	115000	
314ML3		240	4.2	49500	23.7	160 ... 250	—	—	135400	162400	55900	115000	
314ML4		314	3.2	75700	28.5	132 ... 200	—	—	140800	168800	61200	115000	
314ML4		394	2.5	75700	22.7	132 ... 200	—	—	145400	174400	66000	115000	



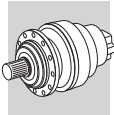

314M L

380

80640 Nm

n ₁ min ⁻¹		i	n ₂ min ⁻¹	M _{n2} Nm	P _{n1} kW	P (IEC)	Rn ₂ [N]					M _{2 max} Nm
							MC	MZ	HC/PC	HZ/PZ	FZ	
1000	314ML4	458	2.2	76400	19.7	132 ... 200	—	—	148600	178200	69400	115000
	314ML4	495	2.0	76800	18.4	132 ... 200	—	—	150200	180200	71200	115000
	314ML4	575	1.7	69700	14.3	132 ... 200	—	—	153500	184100	74800	115000
	314ML4	588	1.7	74700	15.0	132 ... 200	—	—	154000	184700	75400	115000
	314ML4	668	1.5	78400	13.9	132 ... 200	—	—	156800	188100	78700	115000
	314ML4	738	1.4	76100	12.2	132 ... 200	—	—	159100	190800	81300	115000
	314ML4	858	1.2	77100	10.6	132 ... 200	—	—	162500	194900	85500	115000
	314ML4	926	1.1	72800	9.3	132 ... 200	—	—	164300	197000	87700	115000
	314ML4	1038	0.96	78000	8.9	132 ... 200	—	—	167000	200300	90000	115000
	314ML4	1099	0.91	73300	7.9	132 ... 200	—	—	168400	201900	90000	115000
	314ML4	1277	0.78	73300	6.8	132 ... 200	—	—	172000	206300	90000	115000
	314ML4	1485	0.67	63300	5.0	132 ... 200	—	—	175800	210800	90000	115000
	314ML4	1796	0.56	63300	4.2	132 ... 200	—	—	180600	216600	90000	115000
	500	314ML1	4.25	118	41700	260	—	—	—	63000	75600	18400
314ML1		5.33	94	43100	260	—	—	—	67500	80900	19800	115000
314ML1		6.20	81	43500	260	—	—	—	70600	84600	20800	115000
314ML2		17.4	28.8	52900	169	200 ... 250	—	—	96100	115300	29400	115000
314ML2		22.3	22.4	56100	140	200 ... 250	—	—	103600	124300	31900	115000
314ML2		26.5	18.9	52700	111	200 ... 250	—	—	109100	130800	33800	115000
314ML2		28.0	17.9	56800	113	200 ... 250	—	—	110900	133000	34400	115000
314ML2		33.2	15.0	57400	96	200 ... 250	—	—	116800	140000	36500	115000
314ML2		38.6	12.9	47400	68	200 ... 250	—	—	122200	146500	38300	115000
314ML3		62.6	8.0	67500	62	160 ... 250	—	—	132000	158300	45000	115000
314ML3		73.9	6.8	69800	54	160 ... 250	—	—	132000	158300	47600	115000
314ML3		92.7	5.4	73800	46	160 ... 250	—	—	132000	158300	51300	115000
314ML3		108	4.6	74900	40	160 ... 250	—	—	133400	160000	54000	115000
314ML3		138	3.6	72400	30	160 ... 250	—	—	138300	165800	58600	115000
314ML3		164	3.0	59500	20.8	160 ... 250	—	—	141700	169900	62100	115000
314ML3		174	2.9	66400	21.9	160 ... 250	—	—	142800	171300	63300	115000
314ML3		206	2.4	67700	18.8	160 ... 250	—	—	146400	175500	67000	115000
314ML3		240	2.1	55700	13.3	160 ... 250	—	—	149500	179300	70400	115000
314ML4		314	1.6	78100	14.7	132 ... 200	—	—	155400	186400	77100	115000
314ML4		394	1.3	79300	11.9	132 ... 200	—	—	160600	192600	83100	115000
314ML4		458	1.1	80200	10.3	132 ... 200	—	—	164100	196700	87400	115000
314ML4		495	1.0	80600	9.6	132 ... 200	—	—	165900	198900	89700	115000
314ML4		575	0.87	73300	7.5	132 ... 200	—	—	169500	203200	90000	115000
314ML4		588	0.85	78000	7.8	132 ... 200	—	—	170000	203900	90000	115000
314ML4		668	0.75	80600	7.1	132 ... 200	—	—	173200	207700	90000	115000
314ML4		738	0.68	78000	6.3	132 ... 200	—	—	175600	210600	90000	115000
314ML4		858	0.58	78000	5.4	132 ... 200	—	—	179400	215200	90000	115000
314ML4		926	0.54	73300	4.7	132 ... 200	—	—	181400	217600	90000	115000
314ML4		1038	0.48	78000	4.4	132 ... 200	—	—	184400	221100	90000	115000
314ML4		1099	0.46	73300	3.9	132 ... 200	—	—	185900	222900	90000	115000
314ML4		1277	0.39	73300	3.4	132 ... 200	—	—	189900	227800	90000	115000
314ML4		1485	0.34	63300	2.5	132 ... 200	—	—	194100	232700	90000	115000
314ML4		1796	0.28	63300	2.1	132 ... 200	—	—	199400	239200	90000	115000

315M L

392

100800 Nm

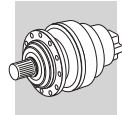

n ₁ min ⁻¹		i	n ₂ min ⁻¹	M _{n2} Nm	P _{n1} kW	P (IEC)	Rn ₂ [N]					M _{2 max} Nm
							MC	MZ	HC/PC	HZ/PZ	FZ	
1500	315ML2	17.4	86	57200	200	200 ... 250	—	—	69200	82900	20400	135000
	315ML2	22.3	67	61600	200	200 ... 250	—	—	74500	89400	22100	135000
	315ML2	26.5	57	64900	200	200 ... 250	—	—	78500	94100	23400	135000
	315ML2	28.0	54	63700	200	200 ... 250	—	—	79800	95700	23900	135000
	315ML2	33.2	45	65600	200	200 ... 250	—	—	84000	100700	25300	135000
	315ML2	38.6	39	59200	200	200 ... 250	—	—	87900	105400	26600	135000



315M L

392

100800 Nm

n ₁ min ⁻¹		i	n ₂ min ⁻¹	M _{n2} Nm	P _{n1} kW	P (IEC) 	Rn ₂ [N]					M ₂ max Nm	
							MC	MZ	HC/PC	HZ/PZ	FZ		
1500	315ML3	59.6	25.2	75800	115	180 ... 250	—	—	100100	120000	30700	135000	
	315ML3	71.1	21.1	77700	115	180 ... 250	—	—	105500	126500	32600	135000	
	315ML3	91.3	16.4	80700	115	180 ... 250	—	—	113700	136400	35400	135000	
	315ML3	108	13.8	83200	115	180 ... 250	—	—	119700	143600	37500	135000	
	315ML3	139	10.8	87800	109	180 ... 250	—	—	129000	154700	40700	135000	
	315ML3	165	9.1	89700	94	180 ... 250	—	—	132000	158300	43100	135000	
	315ML3	174	8.6	75300	74	180 ... 250	—	—	132000	158300	43900	135000	
	315ML3	207	7.2	76100	63	180 ... 250	—	—	132000	158300	46500	135000	
	315ML3	241	6.2	59700	43	180 ... 250	—	—	132000	158300	48900	135000	
	315ML4	302	5.0	94600	56	132 ... 200	—	—	132100	158500	52800	135000	
	315ML4	370	4.1	94600	45	132 ... 200	—	—	136000	163100	56400	135000	
	315ML4	441	3.4	94600	38	132 ... 200	—	—	139500	167300	59800	135000	
	315ML4	487	3.1	94600	34	132 ... 200	—	—	141500	169600	61800	135000	
	315ML4	533	2.8	94600	31	132 ... 200	—	—	143300	171900	63800	135000	
	315ML4	591	2.5	94600	28.4	132 ... 200	—	—	145400	174400	66000	135000	
	315ML4	672	2.2	95400	25.2	132 ... 200	—	—	148100	177600	68900	135000	
	315ML4	741	2.0	96000	23.0	132 ... 200	—	—	150200	180100	71200	135000	
	315ML4	862	1.7	97000	20.0	132 ... 200	—	—	153500	184100	74800	135000	
	315ML4	930	1.6	87800	16.7	132 ... 200	—	—	155200	186100	76800	135000	
	315ML4	1043	1.4	98300	16.7	132 ... 200	—	—	157700	189100	79700	135000	
	315ML4	1104	1.4	89100	14.3	132 ... 200	—	—	159000	190700	81300	135000	
	315ML4	1284	1.2	90400	12.5	132 ... 200	—	—	162500	194800	85400	135000	
	315ML4	1492	1.0	79000	9.4	132 ... 200	—	—	166000	199100	89800	135000	
	315ML4	1805	0.83	79100	7.8	132 ... 200	—	—	170600	204600	90000	135000	
	1000	315ML2	17.4	58	64600	200	200 ... 250	—	—	78100	93700	23300	135000
		315ML2	22.3	45	68600	200	200 ... 250	—	—	84200	100900	25300	135000
		315ML2	26.5	38	70700	200	200 ... 250	—	—	88600	106300	26800	135000
		315ML2	28.0	36	67000	200	200 ... 250	—	—	90100	108100	27300	135000
		315ML2	33.2	30	67900	200	200 ... 250	—	—	94800	113700	28900	135000
		315ML2	38.6	25.9	59200	171	200 ... 250	—	—	99200	119000	30400	135000
		315ML3	59.6	16.8	81300	115	180 ... 250	—	—	113000	135500	35200	135000
		315ML3	71.1	14.1	83600	115	180 ... 250	—	—	119200	142900	37300	135000
		315ML3	91.3	11.0	87300	110	180 ... 250	—	—	128400	154000	40500	135000
		315ML3	108	9.2	89600	95	180 ... 250	—	—	132000	158300	42900	135000
315ML3		139	7.2	91600	76	180 ... 250	—	—	132000	158300	46600	135000	
315ML3		165	6.1	93000	65	180 ... 250	—	—	132000	158300	49400	135000	
315ML3		174	5.7	77200	51	180 ... 250	—	—	132000	158300	50300	135000	
315ML3		207	4.8	78200	43	180 ... 250	—	—	132700	159100	53200	135000	
315ML3		241	4.2	61900	29.5	180 ... 250	—	—	135500	162500	56000	135000	
315ML4		302	3.3	94600	37	132 ... 200	—	—	140000	167900	60400	135000	
315ML4		370	2.7	94600	30	132 ... 200	—	—	144100	172800	64600	135000	
315ML4		441	2.3	95300	25.5	132 ... 200	—	—	147800	177200	68500	135000	
315ML4		487	2.1	95900	23.3	132 ... 200	—	—	149900	179800	70800	135000	
315ML4		533	1.9	96500	21.4	132 ... 200	—	—	151900	182100	73000	135000	
315ML4		591	1.7	97200	19.5	132 ... 200	—	—	154100	184800	75500	135000	
315ML4		672	1.5	98100	17.3	132 ... 200	—	—	156900	188200	78800	135000	
315ML4		741	1.3	98700	15.8	132 ... 200	—	—	159200	190900	81500	135000	
315ML4		862	1.2	99800	13.7	132 ... 200	—	—	162600	195000	85700	135000	
315ML4		930	1.1	91000	11.6	132 ... 200	—	—	164400	197200	87900	135000	
315ML4		1043	0.96	100800	11.4	132 ... 200	—	—	167100	200400	90000	135000	
315ML4		1104	0.91	91600	9.8	132 ... 200	—	—	168500	202100	90000	135000	
315ML4		1284	0.78	91600	8.4	132 ... 200	—	—	172200	206500	90000	135000	
315ML4		1492	0.67	79100	6.3	132 ... 200	—	—	175900	210900	90000	135000	
315ML4		1805	0.55	79100	5.2	132 ... 200	—	—	180700	216800	90000	135000	
500		315ML1	4.25	118	52100	260	—	—	—	63000	75600	18400	135000
		315ML1	5.33	94	53900	260	—	—	—	67500	80900	19800	135000
		315ML1	6.20	81	54300	260	—	—	—	70600	84600	20800	135000

B

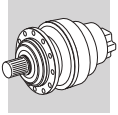



315M L



392

100800 Nm

n ₁ min ⁻¹		i	n ₂ min ⁻¹	M _{n2} Nm	P _{n1} kW	P (IEC) 	Rn ₂ [N]					M _{2 max} Nm
							MC	MZ	HC/PC	HZ/PZ	FZ	
500	315ML2	17.4	28.8	74100	200	200 ... 250	—	—	96100	115300	29400	135000
	315ML2	22.3	22.4	77400	193	200 ... 250	—	—	103600	124300	31900	135000
	315ML2	26.5	18.9	79700	167	200 ... 250	—	—	109100	130800	33800	135000
	315ML2	28.0	17.9	71000	141	200 ... 250	—	—	110900	133000	34400	135000
	315ML2	33.2	15.0	72100	121	200 ... 250	—	—	116800	140000	36500	135000
	315ML2	38.6	12.9	59200	85	200 ... 250	—	—	122200	146500	38300	135000
	315ML3	59.6	8.4	90300	87	180 ... 250	—	—	132000	158300	44300	135000
	315ML3	71.1	7.0	91800	74	180 ... 250	—	—	132000	158300	47000	135000
	315ML3	91.3	5.5	93800	59	180 ... 250	—	—	132000	158300	51100	135000
	315ML3	108	4.6	94600	50	180 ... 250	—	—	133500	160100	54100	135000
	315ML3	139	3.6	94600	39	180 ... 250	—	—	138400	165900	58700	135000
	315ML3	165	3.0	94600	33	180 ... 250	—	—	141800	170000	62200	135000
	315ML3	174	2.9	83000	27.3	180 ... 250	—	—	142900	171400	63400	135000
	315ML3	207	2.4	84600	23.4	180 ... 250	—	—	146500	175600	67100	135000
	315ML3	241	2.1	69700	16.6	180 ... 250	—	—	149600	179500	70500	135000
	315ML4	302	1.7	97400	19.0	132 ... 200	—	—	154600	185400	76100	135000
	315ML4	370	1.4	98700	15.8	132 ... 200	—	—	159100	190800	81400	135000
	315ML4	441	1.1	99900	13.4	132 ... 200	—	—	163200	195700	86300	135000
	315ML4	487	1.0	100600	12.2	132 ... 200	—	—	165500	198500	89200	135000
	315ML4	533	0.94	100800	11.2	132 ... 200	—	—	167700	201100	90000	135000
	315ML4	591	0.85	100800	10.1	132 ... 200	—	—	170100	204000	90000	135000
	315ML4	672	0.74	100800	8.9	132 ... 200	—	—	173300	207800	90000	135000
	315ML4	741	0.67	100800	8.0	132 ... 200	—	—	175700	210800	90000	135000
	315ML4	862	0.58	100800	6.9	132 ... 200	—	—	179600	215300	90000	135000
	315ML4	930	0.54	91600	5.8	132 ... 200	—	—	181500	217700	90000	135000
	315ML4	1043	0.48	100800	5.7	132 ... 200	—	—	184500	221300	90000	135000
	315ML4	1104	0.45	91600	4.9	132 ... 200	—	—	186000	223100	90000	135000
	315ML4	1284	0.39	91600	4.2	132 ... 200	—	—	190100	227900	90000	135000
	315ML4	1492	0.34	79100	3.1	132 ... 200	—	—	194200	232900	90000	135000
	315ML4	1805	0.28	79100	2.6	132 ... 200	—	—	199600	239300	90000	135000



B

316M L



404

134390 Nm

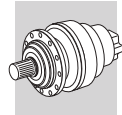

n ₁ min ⁻¹		i	n ₂ min ⁻¹	M _{n2} Nm	P _{n1} kW	P (IEC) 	Rn ₂ [N]					M _{2 max} Nm
							MC	MZ	HC/PC	HZ/PZ	FZ	
1500	316ML2	17.4	86	68500	200	200 ... 250	—	—	105800	118700	33900	192000
	316ML2	21.8	69	78800	200	200 ... 250	—	—	113300	127100	36600	192000
	316ML2	22.3	67	72100	200	200 ... 250	—	—	114000	127900	36900	192000
	316ML2	26.5	57	75000	200	200 ... 250	—	—	120100	134700	39100	192000
	316ML2	28.0	54	85000	200	200 ... 250	—	—	122100	137000	39800	192000
	316ML2	33.2	45	87500	200	200 ... 250	—	—	128500	144200	42100	192000
	316ML3	59.6	25.2	83700	115	180 ... 250	—	—	153200	171800	51200	192000
	316ML3	71.1	21.1	86100	115	180 ... 250	—	—	161500	181200	54300	192000
	316ML3	76.5	19.6	99900	115	180 ... 250	—	—	165100	185200	55600	192000
	316ML3	89.3	16.8	91900	115	180 ... 250	—	—	172900	193900	58600	192000
	316ML3	96.0	15.6	95800	115	180 ... 250	—	—	176700	198200	60000	192000
	316ML3	114	13.2	97200	115	180 ... 250	—	—	186000	208700	63500	192000
	316ML3	117	12.8	111000	115	180 ... 250	—	—	187600	210400	64100	192000
	316ML3	139	10.8	116100	115	180 ... 250	—	—	197400	221500	67900	192000
	316ML3	165	9.1	113600	115	180 ... 250	—	—	202000	226600	71900	192000
	316ML3	174	8.6	99500	98	180 ... 250	—	—	202000	226600	73200	192000
	316ML3	207	7.2	99500	83	180 ... 250	—	—	202000	226600	77500	192000
	316ML4	215	7.0	117100	60	132 ... 200	—	—	202000	226600	78500	192000
	316ML4	253	5.9	120300	60	132 ... 200	—	—	202000	226600	82900	192000
	316ML4	275	5.4	123100	60	132 ... 200	—	—	202000	226600	85300	192000
	316ML4	318	4.7	123900	60	132 ... 200	—	—	203700	228500	89400	192000
	316ML4	346	4.3	101800	52	132 ... 200	—	—	206100	231200	92000	192000



316M L



134390 Nm

n ₁ min ⁻¹		i	n ₂ min ⁻¹	M _{n2} Nm	P _{n1} kW	P (IEC) 	Rn ₂ [N]					M ₂ max Nm
							MC	MZ	HC/PC	HZ/PZ	FZ	
1500	316ML4	399	3.8	104200	46	132 ... 200	—	—	210400	236000	96500	192000
	316ML4	447	3.4	125100	50	132 ... 200	—	—	213800	239900	100200	192000
	316ML4	500	3.0	125500	44	132 ... 200	—	—	217300	243800	104000	192000
	316ML4	563	2.7	113600	36	132 ... 200	—	—	221000	247900	108200	192000
	316ML4	628	2.4	111800	32	132 ... 200	—	—	224500	251800	112200	192000
	316ML4	706	2.1	113200	28.4	132 ... 200	—	—	228300	256100	116700	192000
	316ML4	784	1.9	114400	25.9	132 ... 200	—	—	231700	259900	120800	192000
	316ML4	880	1.7	115500	23.3	132 ... 200	—	—	235600	264300	125600	192000
1000	316ML4	1020	1.5	117500	20.4	132 ... 200	—	—	240600	269900	131900	192000
	316ML4	1104	1.4	118400	19.0	132 ... 200	—	—	243300	273000	135400	192000
	316ML4	1237	1.2	117200	16.8	132 ... 200	—	—	247300	277400	140700	192000
	316ML4	1308	1.1	120500	16.3	132 ... 200	—	—	249300	279700	143300	192000
	316ML4	1553	0.97	122200	14.0	132 ... 200	—	—	255500	286600	150000	192000
	316ML2	17.4	58	77400	200	200 ... 250	—	—	119500	134100	38900	192000
	316ML2	21.8	46	87400	200	200 ... 250	—	—	127900	143500	41900	192000
	316ML2	22.3	45	81000	200	200 ... 250	—	—	128800	144500	42200	192000
	316ML2	26.5	38	83100	200	200 ... 250	—	—	135600	152100	44700	192000
	316ML2	28.0	36	89300	200	200 ... 250	—	—	137900	154700	45500	192000
	316ML2	33.2	30	90600	200	200 ... 250	—	—	145100	162800	48200	192000
	316ML3	59.6	16.8	94500	115	180 ... 250	—	—	173000	194000	58600	192000
	316ML3	71.1	14.1	97200	115	180 ... 250	—	—	182400	204600	62100	192000
	316ML3	76.5	13.1	110800	115	180 ... 250	—	—	186400	209100	63700	192000
	316ML3	89.3	11.2	97800	115	180 ... 250	—	—	195200	219000	67000	192000
	316ML3	96.0	10.4	99200	115	180 ... 250	—	—	199500	223800	68700	192000
	316ML3	114	8.8	99500	100	180 ... 250	—	—	202000	226600	72700	192000
	316ML3	117	8.5	119700	115	180 ... 250	—	—	202000	226600	73400	192000
	316ML3	139	7.2	121000	100	180 ... 250	—	—	202000	226600	77700	192000
	316ML3	165	6.1	113600	79	180 ... 250	—	—	202000	226600	82300	192000
	316ML3	174	5.7	99500	65	180 ... 250	—	—	202000	226600	83800	192000
	316ML3	207	4.8	100100	55	180 ... 250	—	—	203000	227700	88700	192000
	316ML4	215	4.7	123900	60	132 ... 200	—	—	204000	228900	89800	192000
	316ML4	253	3.9	124500	58	132 ... 200	—	—	208900	234400	94900	192000
	316ML4	275	3.6	124800	54	132 ... 200	—	—	211400	237200	97600	192000
	316ML4	318	3.1	125300	47	132 ... 200	—	—	215800	242100	102400	192000
	316ML4	346	2.9	108700	37	132 ... 200	—	—	218400	245000	105300	192000
	316ML4	399	2.5	111300	33	132 ... 200	—	—	222900	250100	110400	192000
	316ML4	447	2.2	126600	33	132 ... 200	—	—	226600	254200	114700	192000
	316ML4	500	2.0	128100	30	132 ... 200	—	—	230300	258300	119100	192000
	316ML4	563	1.8	115300	24.2	132 ... 200	—	—	234200	262700	123900	192000
	316ML4	628	1.6	116500	21.9	132 ... 200	—	—	237900	266800	128500	192000
316ML4	706	1.4	117900	19.7	132 ... 200	—	—	241900	271400	133600	192000	
316ML4	784	1.3	119200	18.0	132 ... 200	—	—	245500	275400	138300	192000	
316ML4	880	1.1	117500	15.8	132 ... 200	—	—	249600	280000	143700	192000	
316ML4	1020	0.98	122200	14.2	132 ... 200	—	—	254900	286000	150000	192000	
316ML4	1104	0.91	122200	13.1	132 ... 200	—	—	257800	289200	150000	192000	
316ML4	1237	0.81	118100	11.3	132 ... 200	—	—	262100	294000	150000	192000	
316ML4	1308	0.76	122200	11.0	132 ... 200	—	—	264200	296300	150000	192000	
316ML4	1553	0.64	122200	9.3	132 ... 200	—	—	270700	303700	150000	192000	
500	316ML1	4.25	118	69500	280	—	—	96400	108200	30600	192000	
	316ML1	5.33	94	71800	280	—	—	103200	115800	33000	192000	
	316ML2	17.4	28.8	92100	200	200 ... 250	—	—	147100	165100	49000	192000
	316ML2	21.8	22.9	92700	200	200 ... 250	—	—	157500	176700	52800	192000
	316ML2	22.3	22.4	96600	200	200 ... 250	—	—	158600	177900	53200	192000
	316ML2	26.5	18.9	97900	200	200 ... 250	—	—	166900	187300	56300	192000
	316ML2	28.0	17.9	94700	188	200 ... 250	—	—	169700	190400	57400	192000
	316ML2	33.2	15.0	96100	161	200 ... 250	—	—	178700	200500	60800	192000
	316ML3	59.6	8.4	113600	109	180 ... 250	—	—	202000	226600	73800	192000
	316ML3	71.1	7.0	115500	93	180 ... 250	—	—	202000	226600	78300	192000
	316ML3	76.5	6.5	121700	91	180 ... 250	—	—	202000	226600	80200	192000



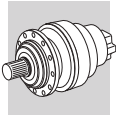



316M L



404

134390 Nm

n ₁ min ⁻¹		i	n ₂ min ⁻¹	M _{n2} Nm	P _{n1} kW	P (IEC) 	Rn ₂ [N]					M _{2 max} Nm
							MC	MZ	HC/PC	HZ/PZ	FZ	
500	316ML3	89.3	5.6	99500	64	180 ... 250	—	—	202000	226600	84500	192000
	316ML3	96.0	5.2	99500	59	180 ... 250	—	—	202000	226600	86500	192000
	316ML3	114	4.4	101600	51	180 ... 250	—	—	205800	230900	91600	192000
	316ML3	117	4.3	124300	61	180 ... 250	—	—	206600	231800	92500	192000
	316ML3	139	3.6	124900	52	180 ... 250	—	—	211700	237500	97900	192000
	316ML3	165	3.0	113600	40	180 ... 250	—	—	217000	243400	103700	192000
	316ML3	174	2.9	108900	36	180 ... 250	—	—	218700	245400	105600	192000
	316ML3	207	2.4	111700	31	180 ... 250	—	—	224100	251400	111800	192000
	316ML4	215	2.3	126400	35	132 ... 200	—	—	225300	252700	113100	192000
	316ML4	253	2.0	127100	29.7	132 ... 200	—	—	230700	258800	119600	192000
	316ML4	275	1.8	129000	27.7	132 ... 200	—	—	233500	261900	123000	192000
	316ML4	318	1.6	128000	23.8	132 ... 200	—	—	238300	267300	129000	192000
	316ML4	346	1.4	117700	20.1	132 ... 200	—	—	241200	270500	132600	192000
	316ML4	399	1.3	119400	17.7	132 ... 200	—	—	246100	276100	139100	192000
	316ML4	447	1.1	129400	17.1	132 ... 200	—	—	250200	280700	144500	192000
	316ML4	500	1.0	134400	15.9	132 ... 200	—	—	254300	285200	150000	192000
	316ML4	563	0.89	118100	12.4	132 ... 200	—	—	258600	290000	150000	192000
	316ML4	628	0.80	122200	11.5	132 ... 200	—	—	262600	294600	150000	192000
	316ML4	706	0.71	122200	10.2	132 ... 200	—	—	267100	299600	150000	192000
	316ML4	784	0.64	122200	9.2	132 ... 200	—	—	271100	304100	150000	192000
	316ML4	880	0.57	118100	7.9	132 ... 200	—	—	275600	309200	150000	192000
	316ML4	1020	0.49	122200	7.1	132 ... 200	—	—	281500	315700	150000	192000
	316ML4	1104	0.45	122200	6.5	132 ... 200	—	—	284700	319400	150000	192000
	316ML4	1237	0.40	118100	5.6	132 ... 200	—	—	289400	324600	150000	192000
	316ML4	1308	0.38	122200	5.5	132 ... 200	—	—	291700	327200	150000	192000
	316ML4	1553	0.32	122200	4.7	132 ... 200	—	—	298900	335300	150000	192000



B

317M L



414

207490 Nm

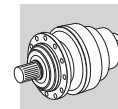

n ₁ min ⁻¹		i	n ₂ min ⁻¹	M _{n2} Nm	P _{n1} kW	P (IEC) 	Rn ₂ [N]					M _{2 max} Nm	
							MC	MZ	HC/PC	HZ/PZ	FZ		
1500	317ML3	58.1	25.8	111900	150	180 ... 250	—	—	236500	251200	50800	393000	
	317ML3	69.3	21.6	115100	150	180 ... 250	—	—	249300	264900	53800	393000	
	317ML3	89.0	16.9	121100	150	180 ... 250	—	—	268700	285500	58500	393000	
	317ML3	106	14.2	125900	150	180 ... 250	—	—	282900	300500	61900	393000	
	317ML3	116	12.9	155100	150	180 ... 250	—	—	291000	309100	63900	393000	
	317ML3	138	10.9	162800	150	180 ... 250	—	—	306300	325400	67700	393000	
	317ML3	166	9.1	121300	126	180 ... 250	—	—	314300	333900	72000	393000	
	317ML3	179	8.4	144000	138	180 ... 250	—	—	314300	333900	73900	393000	
	317ML3	213	7.1	145600	118	180 ... 250	—	—	314300	333900	78200	393000	
	317ML3	252	5.9	113800	78	180 ... 250	—	—	314300	333900	82800	393000	
	317ML4	378	4.0	181400	60	132 ... 200	—	—	324900	345100	94800	393000	
	317ML4	449	3.3	184400	60	132 ... 200	—	—	332900	353700	100300	393000	
	317ML4	493	3.0	166900	60	132 ... 200	—	—	337400	358400	103500	393000	
	317ML4	552	2.7	193500	60	132 ... 200	—	—	342900	364300	107500	393000	
	317ML4	619	2.4	167300	48	132 ... 200	—	—	348500	370300	111600	393000	
	317ML4	719	2.1	169400	42	132 ... 200	—	—	356100	378300	117400	393000	
	317ML4	792	1.9	193700	43	132 ... 200	—	—	361100	383600	121200	393000	
	317ML4	904	1.7	156000	31	132 ... 200	—	—	367900	390900	126700	393000	
	317ML4	1032	1.5	174400	30	132 ... 200	—	—	375000	398400	132400	393000	
	317ML4	1134	1.3	156000	24.4	132 ... 200	—	—	380100	403800	136600	393000	
	317ML4	1318	1.1	156000	21.0	132 ... 200	—	—	388300	412500	143700	393000	
	317ML4	1595	0.94	156000	17.4	132 ... 200	—	—	399000	423900	150000	393000	
	317ML4	1893	0.79	150300	14.1	132 ... 200	—	—	408900	434400	150000	393000	
	1000	317ML2	16.9	59	104300	250	—	—	—	184500	196000	38500	393000
		317ML2	22.1	45	109800	250	—	—	—	199800	212300	42100	393000
		317ML2	26.6	38	106800	250	—	—	—	211200	224400	44800	393000
		317ML2	28.4	35	123400	250	—	—	—	215300	228800	45700	393000
		317ML2	34.1	29.3	126000	250	—	—	—	227600	241800	48700	393000



317M L



207490 Nm

n ₁ min ⁻¹		i	n ₂ min ⁻¹	M _{n2} Nm	P _{n1} kW	P (IEC) 	Rn ₂ [N]					M _{2 max} Nm	
							MC	MZ	HC/PC	HZ/PZ	FZ		
1000	317ML2	40.5	24.7	113000	250	—	—	—	239700	254600	51500	393000	
	317ML3	58.1	17.2	126300	150	180 ... 250	—	—	267100	283700	58100	393000	
	317ML3	69.3	14.4	130000	150	180 ... 250	—	—	281600	299200	61600	393000	
	317ML3	89.0	11.2	136800	150	180 ... 250	—	—	303500	322400	67000	393000	
	317ML3	106	9.5	142200	150	180 ... 250	—	—	314300	333900	70900	393000	
	317ML3	116	8.6	166900	150	180 ... 250	—	—	314300	333900	73200	393000	
	317ML3	138	7.3	166900	139	180 ... 250	—	—	314300	333900	77400	393000	
	317ML3	166	6.0	121300	84	180 ... 250	—	—	314300	333900	82400	393000	
	317ML3	179	5.6	147900	95	180 ... 250	—	—	314300	333900	84600	393000	
	317ML3	213	4.7	149600	81	180 ... 250	—	—	317100	336800	89500	393000	
	317ML3	252	4.0	118800	54	180 ... 250	—	—	324900	345200	94800	393000	
	317ML4	378	2.6	194400	60	132 ... 200	—	—	344200	365700	108500	393000	
	317ML4	449	2.2	193700	51	132 ... 200	—	—	352800	374800	114800	393000	
	317ML4	493	2.0	169800	41	132 ... 200	—	—	357500	379800	118500	393000	
	317ML4	552	1.8	200100	43	132 ... 200	—	—	363300	386000	123000	393000	
	317ML4	619	1.6	172900	33	132 ... 200	—	—	369300	392300	127800	393000	
	317ML4	719	1.4	175100	28.8	132 ... 200	—	—	377300	400900	134400	393000	
	317ML4	792	1.3	193700	28.9	132 ... 200	—	—	382600	406400	138800	393000	
	317ML4	904	1.1	156000	20.4	132 ... 200	—	—	389900	414200	145000	393000	
	317ML4	1032	0.97	179800	20.6	132 ... 200	—	—	397300	422100	150000	393000	
	317ML4	1134	0.88	156000	16.3	132 ... 200	—	—	402700	427800	150000	393000	
	317ML4	1318	0.76	156000	14.0	132 ... 200	—	—	411500	437100	150000	393000	
	317ML4	1595	0.63	156000	11.6	132 ... 200	—	—	422800	449200	150000	393000	
	317ML4	1893	0.53	150300	9.4	132 ... 200	—	—	433300	460300	150000	393000	
	500	317ML2	16.9	29.5	126900	250	—	—	—	227200	241400	48500	393000
		317ML2	22.1	22.6	133100	250	—	—	—	246000	261300	53000	393000
		317ML2	26.6	18.8	114100	239	—	—	—	260100	276300	56400	393000
		317ML2	28.4	17.6	133500	250	—	—	—	265100	281600	57600	393000
		317ML2	34.1	14.7	136300	222	—	—	—	280300	297700	61300	393000
		317ML2	40.5	12.3	113000	155	—	—	—	295000	313400	64900	393000
		317ML3	58.1	8.6	155500	150	180 ... 250	—	—	314300	333900	73200	393000
		317ML3	69.3	7.2	160000	132	180 ... 250	—	—	314300	333900	77600	393000
317ML3		89.0	5.6	168400	109	180 ... 250	—	—	314300	333900	84400	393000	
317ML3		106	4.7	173900	94	180 ... 250	—	—	316800	336500	89300	393000	
317ML3		116	4.3	166900	83	180 ... 250	—	—	321000	341000	92200	393000	
317ML3		138	3.6	166900	70	180 ... 250	—	—	329000	349500	97600	393000	
317ML3		166	3.0	121300	42	180 ... 250	—	—	337800	358900	103800	393000	
317ML3		179	2.8	154800	50	180 ... 250	—	—	341600	362900	106500	393000	
317ML3		213	2.4	156000	42	180 ... 250	—	—	350100	371900	112800	393000	
317ML3		252	2.0	133700	30	180 ... 250	—	—	358700	381100	119400	393000	
317ML4		378	1.3	204000	32	132 ... 200	—	—	380100	403800	136700	393000	
317ML4		449	1.1	193700	25.5	132 ... 200	—	—	389500	413800	144700	393000	
317ML4		493	1.0	179600	21.6	132 ... 200	—	—	394700	419400	149300	393000	
317ML4		552	0.91	207500	22.2	132 ... 200	—	—	401100	426200	150000	393000	
317ML4		619	0.81	179800	17.2	132 ... 200	—	—	407800	433200	150000	393000	
317ML4		719	0.70	179800	14.8	132 ... 200	—	—	416600	442600	150000	393000	
317ML4		792	0.63	193700	14.5	132 ... 200	—	—	422400	448800	150000	393000	
317ML4		904	0.55	156000	10.2	132 ... 200	—	—	430400	457300	150000	393000	
317ML4		1032	0.48	179800	10.3	132 ... 200	—	—	438700	466100	150000	393000	
317ML4		1134	0.44	156000	8.1	132 ... 200	—	—	442000	470000	150000	393000	
317ML4		1318	0.38	156000	7.0	132 ... 200	—	—	442000	470000	150000	393000	
317ML4		1595	0.31	156000	5.8	132 ... 200	—	—	442000	470000	150000	393000	
317ML4		1893	0.26	150300	4.7	132 ... 200	—	—	442000	470000	150000	393000	



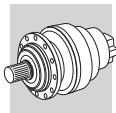



318M L



297550 Nm

B

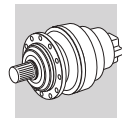

n ₁ min ⁻¹		i	n ₂ min ⁻¹	M _{n2} Nm	P _{n1} kW	P (IEC) 	Rn ₂ [N]					M ₂ max Nm
							MC	MZ	HC/PC	HZ/PZ	FZ	
1500	318ML3	76.5	19.6	194800	200	200 ... 250	—	—	244300	275900	74200	500000
	318ML3	98.2	15.3	205100	200	200 ... 250	—	—	263300	297300	80600	500000
	318ML3	117	12.9	212500	200	200 ... 250	—	—	277200	313000	85300	500000
	318ML3	123	12.2	215000	200	200 ... 250	—	—	281900	318200	86900	500000
	318ML3	146	10.3	222700	200	200 ... 250	—	—	296700	335000	92000	500000
	318ML3	170	8.8	225300	200	200 ... 250	—	—	299000	337600	96800	500000
	318ML4	262	5.7	230200	115	180 ... 250	—	—	299000	337600	111800	500000
	318ML4	313	4.8	233400	115	180 ... 250	—	—	300800	339600	118600	500000
	318ML4	337	4.5	236300	115	180 ... 250	—	—	304000	343200	121500	500000
	318ML4	402	3.7	243400	108	180 ... 250	—	—	311700	352000	128900	500000
	318ML4	422	3.6	245500	103	180 ... 250	—	—	314000	354500	131100	500000
	318ML4	477	3.1	250600	93	180 ... 250	—	—	319400	360700	136500	500000
	318ML4	515	2.9	253900	87	180 ... 250	—	—	323000	364700	140100	500000
	318ML4	612	2.5	261300	76	180 ... 250	—	—	331000	373800	148300	500000
	318ML4	647	2.3	263400	72	180 ... 250	—	—	333700	376800	151100	500000
	318ML4	726	2.1	267800	65	180 ... 250	—	—	339200	383000	157000	500000
	318ML4	768	2.0	270000	62	180 ... 250	—	—	341900	386100	160000	500000
	318ML4	911	1.6	276800	54	180 ... 250	—	—	350400	395700	169400	500000
	318ML4	1059	1.4	261400	44	180 ... 250	—	—	358000	404300	178100	500000
	1000	318ML3	76.5	13.1	211900	200	200 ... 250	—	—	275900	311500	84900
318ML3		98.2	10.2	223100	200	200 ... 250	—	—	297400	335700	92300	500000
318ML3		117	8.6	225600	200	200 ... 250	—	—	299000	337600	97700	500000
318ML3		123	8.1	226200	200	200 ... 250	—	—	299000	337600	99500	500000
318ML3		146	6.8	228200	179	200 ... 250	—	—	299000	337600	105400	500000
318ML3		170	5.9	229900	155	200 ... 250	—	—	299000	337600	110800	500000
318ML4		262	3.8	242600	109	180 ... 250	—	—	310800	350900	128000	500000
318ML4		313	3.2	249900	94	180 ... 250	—	—	318700	359900	135800	500000
318ML4		337	3.0	253000	89	180 ... 250	—	—	322100	363700	139100	500000
318ML4		402	2.5	260700	77	180 ... 250	—	—	330300	373000	147600	500000
318ML4		422	2.4	262600	74	180 ... 250	—	—	332700	375700	150100	500000
318ML4		477	2.1	267200	66	180 ... 250	—	—	338500	382200	156200	500000
318ML4		515	1.9	270300	62	180 ... 250	—	—	342300	386500	160400	500000
318ML4		612	1.6	277100	54	180 ... 250	—	—	350800	396100	169800	500000
318ML4		647	1.5	279300	51	180 ... 250	—	—	353600	399200	173000	500000
318ML4		726	1.4	284000	46	180 ... 250	—	—	359500	405900	179800	500000
318ML4		768	1.3	286400	44	180 ... 250	—	—	362300	409100	183100	500000
318ML4		911	1.1	293600	38	180 ... 250	—	—	371300	419300	193900	500000
318ML4		1059	0.94	264700	29.6	180 ... 250	—	—	379400	428400	200000	500000
500		318ML2	18.7	26.7	182700	260	—	—	—	222600	251300	66900
	318ML2	23.5	21.3	191500	260	—	—	—	238300	269100	72100	500000
	318ML2	27.3	18.3	197600	260	—	—	—	249300	281500	75900	500000
	318ML3	76.5	6.5	228700	171	200 ... 250	—	—	299000	337600	107000	500000
	318ML3	98.2	5.1	231500	135	200 ... 250	—	—	299000	337600	116200	500000
	318ML3	117	4.3	237800	117	200 ... 250	—	—	305600	345100	123100	500000
	318ML3	123	4.1	240000	112	200 ... 250	—	—	308000	347800	125400	500000
	318ML3	146	3.4	247100	97	200 ... 250	—	—	315700	356400	132800	500000
	318ML3	170	2.9	250200	84	200 ... 250	—	—	322500	364200	139600	500000
	318ML4	262	1.9	271000	61	180 ... 250	—	—	343200	387500	161300	500000
	318ML4	313	1.6	278000	53	180 ... 250	—	—	351900	397400	171100	500000
	318ML4	337	1.5	281000	49	180 ... 250	—	—	355600	401500	175300	500000
	318ML4	402	1.2	288200	42	180 ... 250	—	—	364700	411800	185900	500000
	318ML4	422	1.2	290400	41	180 ... 250	—	—	367300	414800	189100	500000
	318ML4	477	1.0	295500	37	180 ... 250	—	—	373700	422000	196800	500000
	318ML4	515	0.97	297600	34	180 ... 250	—	—	377900	426700	200000	500000
	318ML4	612	0.82	297600	28.8	180 ... 250	—	—	387300	437300	200000	500000
	318ML4	647	0.77	297600	27.2	180 ... 250	—	—	390400	440800	200000	500000
	318ML4	726	0.69	297600	24.2	180 ... 250	—	—	396900	448100	200000	500000
	318ML4	768	0.65	297600	22.9	180 ... 250	—	—	400100	451700	200000	500000
318ML4	911	0.55	297600	19.3	180 ... 250	—	—	410000	462900	200000	500000	
318ML4	1059	0.47	264700	14.8	180 ... 250	—	—	418900	473000	200000	500000	



319 L



471190 Nm

n ₁ min ⁻¹		i	n ₂ min ⁻¹	M _{n2} Nm	P _{n1} kW	P (IEC) 	Rn ₂ [N]					M _{2 max} Nm	
							MC	MZ	HC/PC	HZ/PZ	FZ		
1500	319L3	84.8	17.7	213400	200	200 ... 250	—	—	306100	337000	76700	680000	
	319L3	100	15.0	220900	200	200 ... 250	—	—	322000	354500	81200	680000	
	319L3	109	13.8	230000	200	200 ... 250	—	—	329900	363200	83400	680000	
	319L3	126	11.9	236500	200	200 ... 250	—	—	344700	379500	87600	680000	
	319L3	129	11.6	242100	200	200 ... 250	—	—	347300	382400	88300	680000	
	319L3	137	11.0	246200	200	200 ... 250	—	—	353200	388800	90000	680000	
	319L3	162	9.3	251600	200	200 ... 250	—	—	363300	400000	95200	680000	
	319L3	188	8.0	263000	200	200 ... 250	—	—	363300	400000	100100	680000	
	319L3	192	7.8	257200	200	200 ... 250	—	—	363300	400000	100700	680000	
	319L3	223	6.7	262200	200	200 ... 250	—	—	363300	400000	105900	680000	
	319L4	291	5.2	308900	115	180 ... 250	—	—	363300	400000	115700	680000	
	319L4	347	4.3	325700	115	180 ... 250	—	—	370900	408400	122700	680000	
	319L4	410	3.7	287000	115	180 ... 250	—	—	379900	418300	129800	680000	
	319L4	445	3.4	351000	115	180 ... 250	—	—	384300	423200	133400	680000	
	319L4	515	2.9	298100	103	180 ... 250	—	—	392500	432100	140000	680000	
	319L4	528	2.8	369500	115	180 ... 250	—	—	393900	433700	141200	680000	
	319L4	558	2.7	375700	115	180 ... 250	—	—	397000	437100	143900	680000	
	319L4	571	2.6	378200	115	180 ... 250	—	—	398300	438500	145000	680000	
	319L4	625	2.4	307900	87	180 ... 250	—	—	403500	444200	149400	680000	
	319L4	678	2.2	390100	102	180 ... 250	—	—	408200	449400	153500	680000	
	319L4	717	2.1	399500	99	180 ... 250	—	—	411400	453000	156300	680000	
	319L4	802	1.9	321000	71	180 ... 250	—	—	418100	460300	162300	680000	
	319L4	850	1.8	403900	84	180 ... 250	—	—	421600	464200	165500	680000	
	319L4	912	1.6	319400	62	180 ... 250	—	—	425800	468800	169400	680000	
	319L4	1007	1.5	333400	59	180 ... 250	—	—	431900	475500	175100	680000	
	319L4	1195	1.3	343000	51	180 ... 250	—	—	442600	487300	185400	680000	
	319L4	1389	1.1	333700	43	180 ... 250	—	—	452200	497900	194900	680000	
	1000	319L3	84.8	11.8	241000	200	200 ... 250	—	—	345700	380600	87900	680000
		319L3	100	10.0	249300	200	200 ... 250	—	—	363300	400000	92900	680000
		319L3	109	9.2	259800	200	200 ... 250	—	—	363300	400000	95500	680000
		319L3	126	7.9	256700	200	200 ... 250	—	—	363300	400000	100200	680000
		319L3	129	7.7	273400	200	200 ... 250	—	—	363300	400000	101100	680000
319L3		137	7.3	278100	200	200 ... 250	—	—	363300	400000	103000	680000	
319L3		162	6.2	265100	188	200 ... 250	—	—	363300	400000	108900	680000	
319L3		188	5.3	281200	171	200 ... 250	—	—	363300	400000	114600	680000	
319L3		192	5.2	271000	162	200 ... 250	—	—	363300	400000	115300	680000	
319L3		223	4.5	277400	143	200 ... 250	—	—	369000	406200	121300	680000	
319L4		291	3.4	348800	115	180 ... 250	—	—	383200	421900	132500	680000	
319L4		347	2.9	367800	115	180 ... 250	—	—	393000	432700	140500	680000	
319L4		410	2.4	307100	89	180 ... 250	—	—	402600	443200	148600	680000	
319L4		445	2.2	393200	105	180 ... 250	—	—	407300	448400	152700	680000	
319L4		515	1.9	319000	73	180 ... 250	—	—	415900	457900	160300	680000	
319L4		528	1.9	390600	87	180 ... 250	—	—	417400	459500	161700	680000	
319L4		558	1.8	413600	88	180 ... 250	—	—	420700	463200	164700	680000	
319L4		571	1.8	405900	84	180 ... 250	—	—	422000	464700	165900	680000	
319L4		625	1.6	329400	62	180 ... 250	—	—	427500	470700	171000	680000	
319L4		678	1.5	411400	72	180 ... 250	—	—	432500	476200	175700	680000	
319L4		717	1.4	437400	72	180 ... 250	—	—	436000	480000	179000	680000	
319L4		802	1.2	343400	51	180 ... 250	—	—	443000	487800	185800	680000	
319L4		850	1.2	428500	60	180 ... 250	—	—	446800	491900	189500	680000	
319L4		912	1.1	333200	43	180 ... 250	—	—	451200	496800	193900	680000	
319L4		1007	0.99	356300	42	180 ... 250	—	—	457600	503900	200000	680000	
319L4		1195	0.84	356300	35	180 ... 250	—	—	469000	516300	200000	680000	
319L4		1389	0.72	336400	28.7	180 ... 250	—	—	479200	527600	200000	680000	
500		319L2	20.7	24.1	194500	260	—	—	—	278900	307100	69200	680000
		319L2	24.5	20.4	201300	260	—	—	—	293400	323000	73200	680000
		319L2	26.0	19.2	208200	260	—	—	—	298600	328700	74700	680000
		319L2	30.8	16.3	215500	260	—	—	—	314100	345800	79000	680000
		319L2	35.8	14.0	225400	260	—	—	—	328600	361800	83000	680000
	319L3	84.8	5.9	296700	200	200 ... 250	—	—	363300	400000	110700	680000	

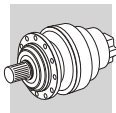

B



319 L



471190 Nm



n ₁ min ⁻¹		i	n ₂ min ⁻¹	M _{n2} Nm	P _{n1} kW	P (IEC) 	R _{n2} [N]					M _{2 max} Nm
							MC	MZ	HC/PC	HZ/PZ	FZ	
500	319L3	100	5.0	272600	156	200 ... 250	—	—	363500	400200	117100	680000
	319L3	109	4.6	319800	169	200 ... 250	—	—	367700	404800	120300	680000
	319L3	126	4.0	283100	129	200 ... 250	—	—	375400	413400	126300	680000
	319L3	129	3.9	336700	150	200 ... 250	—	—	376800	414900	127400	680000
	319L3	137	3.7	342300	144	200 ... 250	—	—	379800	418200	129700	680000
	319L3	162	3.1	295100	105	200 ... 250	—	—	389100	428400	137200	680000
	319L3	188	2.7	284000	87	200 ... 250	—	—	397700	437900	144400	680000
	319L3	192	2.6	303700	91	200 ... 250	—	—	398700	439000	145300	680000
	319L3	223	2.2	309300	80	200 ... 250	—	—	407400	448500	152800	680000
	319L4	291	1.7	417300	85	180 ... 250	—	—	423100	465800	166900	680000
	319L4	347	1.4	434200	74	180 ... 250	—	—	433900	477800	177000	680000
	319L4	410	1.2	344700	50	180 ... 250	—	—	444500	489400	187300	680000
	319L4	445	1.1	459100	61	180 ... 250	—	—	449700	495100	192400	680000
	319L4	515	0.97	356300	41	180 ... 250	—	—	459100	505500	200000	680000
	319L4	528	0.95	406500	46	180 ... 250	—	—	460800	507300	200000	680000
	319L4	558	0.90	471200	50	180 ... 250	—	—	464500	511400	200000	680000
	319L4	571	0.88	443000	46	180 ... 250	—	—	466000	513000	200000	680000
	319L4	625	0.80	356300	34	180 ... 250	—	—	472000	519700	200000	680000
	319L4	678	0.74	433000	38	180 ... 250	—	—	477500	525800	200000	680000
	319L4	717	0.70	471200	39	180 ... 250	—	—	481300	530000	200000	680000
319L4	802	0.62	356300	26.3	180 ... 250	—	—	489100	538600	200000	680000	
319L4	850	0.59	438800	31	180 ... 250	—	—	493300	543100	200000	680000	
319L4	912	0.55	336400	21.8	180 ... 250	—	—	498200	548500	200000	680000	
319L4	1007	0.50	356300	20.9	180 ... 250	—	—	505300	556300	200000	680000	
319L4	1195	0.42	356300	17.6	180 ... 250	—	—	517800	570100	200000	680000	
319L4	1389	0.36	336400	14.3	180 ... 250	—	—	529000	582500	200000	680000	

B

321 L



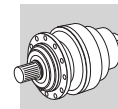

655740 Nm

n ₁ min ⁻¹		i	n ₂ min ⁻¹	M _{n2} Nm	P _{n1} kW	P (IEC) 	R _{n2} [N]					M _{2 max} Nm	
							MC	MZ	HC/PC	HZ/PZ	FZ		
1500	321L4	258	5.8	401700	150	180 ... 250	—	—	513900	611700	707900	934000	
	321L4	308	4.9	423600	150	180 ... 250	—	—	515900	614000	746400	934000	
	321L4	395	3.8	456500	150	180 ... 250	—	—	534600	636300	804400	934000	
	321L4	469	3.2	480500	150	180 ... 250	—	—	547800	652100	846800	934000	
	321L4	515	2.9	494200	150	180 ... 250	—	—	555200	660900	871000	934000	
	321L4	612	2.5	519900	150	180 ... 250	—	—	569000	677200	916900	934000	
	321L4	736	2.0	545400	131	180 ... 250	—	—	584200	695400	969400	934000	
	321L4	796	1.9	556600	124	180 ... 250	—	—	590800	703200	992400	934000	
	321L4	945	1.6	581800	109	180 ... 250	—	—	605400	720700	1044700	934000	
	321L4	1122	1.3	530200	84	180 ... 250	—	—	620400	738500	1099800	934000	
	1000	321L3	75.3	13.3	313500	250	—	—	—	472000	561800	552400	934000
		321L3	98.2	10.2	339400	250	—	—	—	511100	608300	598100	934000
321L3		118	8.5	358800	250	—	—	—	513900	611700	632300	934000	
321L3		126	7.9	365800	250	—	—	—	513900	611700	644600	934000	
321L3		152	6.6	386700	250	—	—	—	513900	611700	681500	934000	
321L3		180	5.6	407100	250	—	—	—	513900	611700	717400	934000	
321L4		258	3.9	453700	150	180 ... 250	—	—	533000	634500	799500	934000	
321L4		308	3.2	478300	150	180 ... 250	—	—	546600	650700	843000	934000	
321L4		395	2.5	515500	150	180 ... 250	—	—	566500	674300	908500	934000	
321L4		469	2.1	539100	136	180 ... 250	—	—	580500	691000	956400	934000	
321L4		515	1.9	552400	127	180 ... 250	—	—	588300	700300	983600	934000	
321L4		612	1.6	577400	112	180 ... 250	—	—	602900	717600	1035500	934000	
321L4		736	1.4	605800	97	180 ... 250	—	—	619100	736900	1094700	934000	
321L4		796	1.3	618200	92	180 ... 250	—	—	626000	745200	1120700	934000	
321L4		945	1.1	646200	81	180 ... 250	—	—	641500	763600	1179800	934000	
321L4		1122	0.89	536400	57	180 ... 250	—	—	657400	782500	1200000	934000	





321 L 444

655740 Nm

n ₁ min ⁻¹		i	n ₂ min ⁻¹	M _{n2} Nm	P _{n1} kW	P (IEC) 	Rn ₂ [N]					M _{2 max} Nm
							MC	MZ	HC/PC	HZ/PZ	FZ	
500	321L3	75.3	6.6	385900	250	—	—	—	513900	611700	680100	934000
	321L3	98.2	5.1	417900	244	—	—	—	513900	611700	736400	934000
	321L3	118	4.2	441800	214	—	—	—	526300	626500	778500	934000
	321L3	126	4.0	450300	205	—	—	—	531200	632200	793600	934000
	321L3	152	3.3	476100	180	—	—	—	545400	649200	839000	934000
	321L3	180	2.8	501200	160	—	—	—	558900	665300	883200	934000
	321L4	258	1.9	552700	127	180 ... 250	—	—	588500	700500	984200	934000
	321L4	308	1.6	578500	111	180 ... 250	—	—	603500	718400	1037800	934000
	321L4	395	1.3	617100	92	180 ... 250	—	—	625400	744500	1118500	934000
	321L4	469	1.1	645100	81	180 ... 250	—	—	640900	762900	1177400	934000
	321L4	515	0.97	655700	75	180 ... 250	—	—	649600	773200	1200000	934000
	321L4	612	0.82	655700	63	180 ... 250	—	—	665700	792300	1200000	934000
	321L4	736	0.68	655700	53	180 ... 250	—	—	683500	813600	1200000	934000
	321L4	796	0.63	655700	49	180 ... 250	—	—	691200	822700	1200000	934000
	321L4	945	0.53	655700	41	180 ... 250	—	—	708300	843100	1200000	934000
	321L4	1122	0.45	536400	28.3	180 ... 250	—	—	725900	864000	1200000	934000

323 L 454

890310 Nm

n ₁ min ⁻¹		i	n ₂ min ⁻¹	M _{n2} Nm	P _{n1} kW	P (IEC) 	Rn ₂ [N]					M _{2 max} Nm	
							MC	MZ	HC/PC	HZ/PZ	FZ		
1500	323L4	341	4.4	757500	200	200 ... 250	—	—	—	—	705300	1580000	
	323L4	390	3.8	774100	200	200 ... 250	—	—	—	—	734300	1580000	
	323L4	438	3.4	788700	200	200 ... 250	—	—	—	—	760100	1580000	
	323L4	500	3.0	806000	200	200 ... 250	—	—	—	—	791300	1580000	
	323L4	569	2.6	822800	200	200 ... 250	—	—	—	—	822300	1580000	
	323L4	628	2.4	832800	200	200 ... 250	—	—	—	—	847100	1580000	
	323L4	703	2.1	840100	200	200 ... 250	—	—	—	—	876200	1580000	
	323L4	758	2.0	844900	198	200 ... 250	—	—	—	—	896200	1580000	
	323L4	882	1.7	854800	172	200 ... 250	—	—	—	—	938000	1580000	
	323L4	1025	1.5	864700	150	200 ... 250	—	—	—	—	981300	1580000	
	323L4	1101	1.4	869400	140	200 ... 250	—	—	—	—	1002400	1580000	
	323L4	1279	1.2	879500	122	200 ... 250	—	—	—	—	1048800	1580000	
	1000	323L4	341	2.9	808800	200	200 ... 250	—	—	—	—	796500	1580000
		323L4	390	2.6	826500	200	200 ... 250	—	—	—	—	829200	1580000
323L4		438	2.3	835700	200	200 ... 250	—	—	—	—	858400	1580000	
323L4		500	2.0	844300	200	200 ... 250	—	—	—	—	893700	1580000	
323L4		569	1.8	852600	177	200 ... 250	—	—	—	—	928700	1580000	
323L4		628	1.6	859100	162	200 ... 250	—	—	—	—	956700	1580000	
323L4		703	1.4	866600	146	200 ... 250	—	—	—	—	989500	1580000	
323L4		758	1.3	871600	136	200 ... 250	—	—	—	—	1012100	1580000	
323L4		882	1.1	881800	118	200 ... 250	—	—	—	—	1059300	1580000	
323L4		1025	0.98	890300	103	200 ... 250	—	—	—	—	1100000	1580000	
323L4		1101	0.91	890300	96	200 ... 250	—	—	—	—	1100000	1580000	
323L4		1279	0.78	890300	82	200 ... 250	—	—	—	—	1100000	1580000	
500		323L3	83.3	6.0	702600	260	—	—	—	—	—	642600	1580000
		323L3	105	4.8	747400	260	—	—	—	—	—	687900	1580000
	323L3	113	4.4	756600	260	—	—	—	—	—	703700	1580000	
	323L3	120	4.2	763800	260	—	—	—	—	—	716200	1580000	
	323L3	142	3.5	784900	260	—	—	—	—	—	753300	1580000	
	323L3	165	3.0	804200	260	—	—	—	—	—	788100	1580000	
	323L3	205	2.4	831600	232	—	—	—	—	—	842300	1580000	
	323L4	341	1.5	864600	150	200 ... 250	—	—	—	—	980600	1580000	
	323L4	390	1.3	873500	132	200 ... 250	—	—	—	—	1020900	1580000	
	323L4	438	1.1	881300	119	200 ... 250	—	—	—	—	1056800	1580000	
	323L4	500	1.0	890300	105	200 ... 250	—	—	—	—	1100000	1580000	
	323L4	569	0.88	890300	93	200 ... 250	—	—	—	—	1100000	1580000	
	323L4	628	0.80	890300	84	200 ... 250	—	—	—	—	1100000	1580000	

B

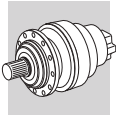

323 L



454

890310 Nm

n ₁ min ⁻¹		i	n ₂ min ⁻¹	M _{n2} Nm	P _{n1} kW	P (IEC)	Rn ₂ [N]					M _{2 max} Nm
							MC	MZ	HC/PC	HZ/PZ	FZ	
500	323L4	703	0.71	890300	75	200 ... 250	—	—	—	—	1100000	1580000
	323L4	758	0.66	890300	70	200 ... 250	—	—	—	—	1100000	1580000
	323L4	882	0.57	890300	60	200 ... 250	—	—	—	—	1100000	1580000
	323L4	1025	0.49	890300	51	200 ... 250	—	—	—	—	1100000	1580000
	323L4	1101	0.45	890300	48	200 ... 250	—	—	—	—	1100000	1580000
	323L4	1279	0.39	890300	41	200 ... 250	—	—	—	—	1100000	1580000

325 L



458

1286700 Nm

n ₁ min ⁻¹		i	n ₂ min ⁻¹	M _{n2} Nm	P _{n1} kW	P (IEC)	Rn ₂ [N]					M _{2 max} Nm	
							MC	MZ	HC/PC	HZ/PZ	FZ		
1500	325L4	341	4.4	931900	200	200 ... 250	—	—	—	—	897700	2000000	
	325L4	390	3.8	952300	200	200 ... 250	—	—	—	—	934500	2000000	
	325L4	438	3.4	1004300	200	200 ... 250	—	—	—	—	967400	2000000	
	325L4	500	3.0	1026300	200	200 ... 250	—	—	—	—	1007100	2000000	
	325L4	569	2.6	1066500	200	200 ... 250	—	—	—	—	1046600	2000000	
	325L4	628	2.4	1093000	200	200 ... 250	—	—	—	—	1078100	2000000	
	325L4	703	2.1	1101500	200	200 ... 250	—	—	—	—	1115200	2000000	
	325L4	758	2.0	1147900	200	200 ... 250	—	—	—	—	1140600	2000000	
	325L4	882	1.7	1154000	200	200 ... 250	—	—	—	—	1193800	2000000	
	325L4	1025	1.5	1190200	200	200 ... 250	—	—	—	—	1248900	2000000	
	325L4	1101	1.4	963200	155	200 ... 250	—	—	—	—	1275800	2000000	
	325L4	1279	1.2	963200	134	200 ... 250	—	—	—	—	1334800	2000000	
	1000	325L4	341	2.9	1052400	200	200 ... 250	—	—	—	—	1013800	2000000
		325L4	390	2.6	1075400	200	200 ... 250	—	—	—	—	1055400	2000000
325L4		438	2.3	1120700	200	200 ... 250	—	—	—	—	1092500	2000000	
325L4		500	2.0	1130200	200	200 ... 250	—	—	—	—	1137400	2000000	
325L4		569	1.8	1157600	200	200 ... 250	—	—	—	—	1182000	2000000	
325L4		628	1.6	1179300	200	200 ... 250	—	—	—	—	1217600	2000000	
325L4		703	1.4	1197000	200	200 ... 250	—	—	—	—	1259400	2000000	
325L4		758	1.3	1228300	192	200 ... 250	—	—	—	—	1288100	2000000	
325L4		882	1.1	1254000	168	200 ... 250	—	—	—	—	1348200	2000000	
325L4		1025	0.98	1286700	148	200 ... 250	—	—	—	—	1400000	2000000	
325L4		1101	0.91	963200	104	200 ... 250	—	—	—	—	1400000	2000000	
325L4		1279	0.78	963200	89	200 ... 250	—	—	—	—	1400000	2000000	
500		325L3	83.3	6.0	849100	260	—	—	—	—	—	817900	2000000
		325L3	105	4.8	908900	260	—	—	—	—	—	875600	2000000
	325L3	113	4.4	898100	260	—	—	—	—	—	895600	2000000	
	325L3	120	4.2	928800	260	—	—	—	—	—	911500	2000000	
	325L3	142	3.5	961400	260	—	—	—	—	—	958700	2000000	
	325L3	165	3.0	1005800	260	—	—	—	—	—	1003000	2000000	
	325L3	205	2.4	963200	260	—	—	—	—	—	1072000	2000000	
	325L4	341	1.5	1206900	200	200 ... 250	—	—	—	—	1248100	2000000	
	325L4	390	1.3	1228100	186	200 ... 250	—	—	—	—	1299300	2000000	
	325L4	438	1.1	1258300	170	200 ... 250	—	—	—	—	1345100	2000000	
	325L4	500	1.0	1286700	152	200 ... 250	—	—	—	—	1400000	2000000	
	325L4	569	0.88	1286700	134	200 ... 250	—	—	—	—	1400000	2000000	
	325L4	628	0.80	1286700	121	200 ... 250	—	—	—	—	1400000	2000000	
	325L4	703	0.71	1286700	108	200 ... 250	—	—	—	—	1400000	2000000	
	325L4	758	0.66	1286600	100	200 ... 250	—	—	—	—	1400000	2000000	
	325L4	882	0.57	1286700	86	200 ... 250	—	—	—	—	1400000	2000000	
	325L4	1025	0.49	1286700	74	200 ... 250	—	—	—	—	1400000	2000000	
	325L4	1101	0.45	963200	52	200 ... 250	—	—	—	—	1400000	2000000	
325L4	1279	0.39	963200	45	200 ... 250	—	—	—	—	1400000	2000000		

B

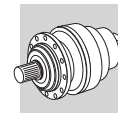

25.4 RATING CHARTS FOR RIGHT ANGLE UNITS 300M R

Reading the rating chart.

314M R							80640 Nm						
n_1 min ⁻¹		i	n_2 min ⁻¹	M_{n2} Nm	P_{n1} kW	P (IEC)	MC	MZ	R_{n2} [N]		FZ	$M_{2\ max}$ Nm	
									HC/PC	HZ/PZ			
1500	314MR3B	51.1	29.4	39100	130	180 ... 250	—	—	95500	114600	29200	115000	
	314MR3B	65.5	22.9	50200	130	180 ... 250	—	—	103000	123500	31700	115000	
	314MR3B	77.8	19.3	52500	116	180 ... 250	—	—	108400	130000	33600	115000	
	314MR3B	82.3	18.2	54400	114	180 ... 250	—	—	110200	132200	34200	115000	
	314MR3B	97.6	15.4	57300	101	180 ... 250	—	—	116000	139200	36200	115000	

The rated torque of the gearbox, independent of installed mechanical power

1	Reference torque	8	Frame size of available IEC motor
2	Gearbox drive speed	9	Permitted overhung loading on output shaft, based on: - service factor $f_S=1$ - 10000 h theoretical lifetime - speed of output n_2 For forces not applied at shaft midpoint, see diagrams provided in the specific gearbox overall dimensioning pages
3	Frame size of the right-angle gear unit. NOTE: letters (B) (C) near size indication identify different angle reduction dimensions. See dimensions pages.	10	Maximum torque
4	Gear ratio	11	Dimensions page
5	Gearbox output speed		
6	Gearbox rated output torque based on: - service factor $f_S=1$ - 10000 h theoretical lifetime		
7	Gearbox rated input power, based on: - service factor $f_S=1$ - 10000 h theoretical lifetime		

B

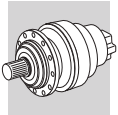

300 R



1250 Nm

n ₁ min ⁻¹	i	n ₂ min ⁻¹	M _{n2} Nm	P _{n1} kW	P (IEC)	Rn ₂ [N]					M _{2 max} Nm	
						MC/PC	MZ/PZ	HC	HZ	FZ		
1500	300R2	7.13	210	580	13.7	71 ... 132	2360	2360	8620	10000	1350	2000
	300R2	8.74	172	610	11.7	71 ... 132	2520	2520	9160	10700	1440	2400
	300R2	11.8	127	590	8.3	71 ... 132	2790	2790	10000	11700	1590	2400
	300R2	14.8	102	510	5.7	71 ... 132	3000	3000	10700	12500	1710	2400
	300R2	18.5	81	370	3.3	71 ... 132	3230	3230	11500	13300	1850	2400
	300R3	24.8	60	730	5.1	71 ... 132	3570	3570	12500	14600	2040	2000
	300R3	30.4	49	840	4.8	71 ... 132	3820	3820	13300	15500	2180	2400
	300R3	37.3	40	840	3.9	71 ... 132	4090	4090	14200	16500	2330	2400
	300R3	41.2	36	650	2.7	71 ... 132	4220	4220	14600	17000	2410	2400
	300R3	50.4	29.8	850	2.9	71 ... 132	4520	4520	15500	18000	2580	2400
	300R3	62.9	23.8	850	2.3	71 ... 132	4870	4870	16600	19300	2780	2400
	300R3	68.2	22.0	650	1.6	71 ... 132	5000	5000	17000	19700	2860	2400
	300R3	78.7	19.1	850	1.9	71 ... 132	5240	5240	17700	20600	2990	2400
	300R3	85.2	17.6	650	1.3	71 ... 132	5380	5380	18100	21100	3070	2400
	300R3	106	14.1	650	1.1	71 ... 132	5800	5800	19400	22600	3310	2400
	300R3	133	11.3	550	0.71	71 ... 132	6240	6240	20700	24100	3570	2400
	300R4	106	14.2	860	1.4	71 ... 132	5790	5790	19400	22500	3310	2400
	300R4	130	11.6	860	1.2	71 ... 132	6190	6190	20600	23900	3540	2400
	300R4	143	10.5	650	0.81	71 ... 132	6400	6400	21200	24700	3660	2400
	300R4	159	9.4	870	0.97	71 ... 132	6500	6500	21500	25000	3780	2400
	300R4	175	8.5	880	0.89	71 ... 132	6500	6500	21500	25000	3910	2400
	300R4	215	7.0	910	0.75	71 ... 132	6500	6500	21500	25000	4190	2400
	300R4	237	6.3	650	0.49	71 ... 132	6500	6500	21500	25000	4330	2400
	300R4	268	5.6	930	0.62	71 ... 132	6500	6500	21500	25000	4510	2400
	300R4	291	5.2	950	0.58	71 ... 132	6500	6500	21500	25000	4630	2400
	300R4	363	4.1	980	0.48	71 ... 132	6680	6680	22100	25700	4990	2400
	300R4	394	3.8	680	0.31	71 ... 132	6760	6760	22400	26000	5120	2400
	300R4	453	3.3	1020	0.40	71 ... 132	6890	6890	22800	26500	5370	2400
	300R4	491	3.1	710	0.25	71 ... 132	6970	6970	23100	26800	5510	2400
	300R4	613	2.4	730	0.21	71 ... 132	7200	7200	23800	27700	5940	2400
	300R4	766	2.0	760	0.18	71 ... 132	7430	7430	24600	28600	6400	2400
	1000	300R2	7.13	140	660	10.3	71 ... 132	2700	2700	9740	11300	1540
300R2		8.74	114	690	8.8	71 ... 132	2880	2880	10300	12000	1650	2400
300R2		11.8	85	630	6.0	71 ... 132	3190	3190	11300	13200	1820	2400
300R2		14.8	68	530	4.0	71 ... 132	3440	3440	12100	14100	1960	2400
300R2		18.5	54	370	2.2	71 ... 132	3700	3700	12900	15100	2110	2400
300R3		24.8	40	730	3.4	71 ... 132	4090	4090	14200	16500	2330	2000
300R3		30.4	33	850	3.2	71 ... 132	4370	4370	15000	17500	2500	2400
300R3		37.3	26.8	850	2.6	71 ... 132	4680	4680	16000	18600	2670	2400
300R3		41.2	24.3	650	1.8	71 ... 132	4840	4840	16500	19200	2760	2400
300R3		50.4	19.8	850	1.9	71 ... 132	5170	5170	17500	20400	2960	2400
300R3		62.9	15.9	850	1.6	71 ... 132	5570	5570	18700	21800	3180	2400
300R3		68.2	14.7	650	1.1	71 ... 132	5720	5720	19200	22300	3270	2400
300R3		78.7	12.7	860	1.3	71 ... 132	6000	6000	20000	23300	3430	2400
300R3		85.2	11.7	650	0.88	71 ... 132	6160	6160	20500	23800	3520	2400
300R3		106	9.4	650	0.70	71 ... 132	6500	6500	21500	25000	3790	2400
300R3		133	7.5	550	0.48	71 ... 132	6500	6500	21500	25000	4080	2400
300R4		106	9.4	870	0.97	71 ... 132	6500	6500	21500	25000	3780	2400
300R4		130	7.7	890	0.81	71 ... 132	6500	6500	21500	25000	4050	2400
300R4		143	7.0	650	0.54	71 ... 132	6500	6500	21500	25000	4190	2400
300R4		159	6.3	920	0.68	71 ... 132	6500	6500	21500	25000	4330	2400
300R4		175	5.7	930	0.63	71 ... 132	6500	6500	21500	25000	4480	2400
300R4		215	4.7	960	0.53	71 ... 132	6570	6570	21700	25300	4790	2400
300R4		237	4.2	670	0.33	71 ... 132	6660	6660	22000	25600	4950	2400
300R4		268	3.7	1000	0.44	71 ... 132	6780	6780	22400	26100	5160	2400
300R4		291	3.4	1010	0.41	71 ... 132	6860	6860	22700	26400	5300	2400
300R4		363	2.8	1050	0.34	71 ... 132	7080	7080	23400	27200	5710	2400
300R4		394	2.5	730	0.22	71 ... 132	7160	7160	23700	27500	5860	2400
300R4		453	2.2	1090	0.29	71 ... 132	7310	7310	24200	28100	6140	2400
300R4		491	2.0	760	0.18	71 ... 132	7390	7390	24400	28400	6310	2400
300R4		613	1.6	790	0.15	71 ... 132	7630	7630	25200	29300	6800	2400
300R4		766	1.3	820	0.13	71 ... 132	7880	7880	26000	30300	7320	2400

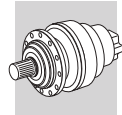

300 R 254

1250 Nm

n ₁ min ⁻¹		i	n ₂ min ⁻¹	M _{n2} Nm	P _{n1} kW	P (IEC)	Rn ₂ [N]					M _{2 max} Nm
							MC/PC	MZ/PZ	HC	HZ	FZ	
500	300R2	7.13	70	730	5.7	71 ... 132	3400	3400	12000	13900	1940	2000
	300R2	8.74	57	820	5.2	71 ... 132	3630	3630	12700	14800	2080	2400
	300R2	11.8	42	650	3.1	71 ... 132	4020	4020	14000	16200	2300	2400
	300R2	14.8	34	550	2.1	71 ... 132	4330	4330	14900	17300	2470	2400
	300R2	18.5	27.1	370	1.1	71 ... 132	4660	4660	15900	18500	2660	2400
	300R3	24.8	20.1	730	1.7	71 ... 132	5150	5150	17400	20300	2940	2000
	300R3	30.4	16.4	850	1.6	71 ... 132	5510	5510	18500	21500	3150	2400
	300R3	37.3	13.4	860	1.3	71 ... 132	5890	5890	19700	22900	3370	2400
	300R3	41.2	12.1	650	0.91	71 ... 132	6090	6090	20300	23600	3480	2400
	300R3	50.4	9.9	860	0.98	71 ... 132	6500	6500	21500	25000	3720	2400
	300R3	62.9	7.9	890	0.81	71 ... 132	6500	6500	21500	25000	4010	2400
	300R3	68.2	7.3	650	0.55	71 ... 132	6500	6500	21500	25000	4120	2400
	300R3	78.7	6.4	920	0.67	71 ... 132	6500	6500	21500	25000	4320	2400
	300R3	85.2	5.9	650	0.44	71 ... 132	6500	6500	21500	25000	4430	2400
	300R3	106	4.7	660	0.35	71 ... 132	6560	6560	21700	25200	4780	2400
	300R3	133	3.8	570	0.25	71 ... 132	6770	6770	22400	26000	5140	2400
	300R4	106	4.7	960	0.54	71 ... 132	6550	6550	21700	25200	4770	2400
	300R4	130	3.9	990	0.45	71 ... 132	6750	6750	22300	25900	5100	2400
	300R4	143	3.5	690	0.29	71 ... 132	6840	6840	22600	26300	5270	2400
	300R4	159	3.1	1030	0.38	71 ... 132	6940	6940	23000	26700	5460	2400
	300R4	175	2.8	1050	0.35	71 ... 132	7040	7040	23300	27100	5640	2400
	300R4	215	2.3	1080	0.30	71 ... 132	7250	7250	24000	27900	6040	2400
	300R4	237	2.1	750	0.19	71 ... 132	7350	7350	24300	28300	6240	2400
	300R4	268	1.9	1120	0.25	71 ... 132	7480	7480	24800	28800	6500	2400
	300R4	291	1.7	1140	0.23	71 ... 132	7570	7570	25000	29100	6680	2400
	300R4	363	1.4	1180	0.19	71 ... 132	7810	7810	25800	30100	7190	2400
	300R4	394	1.3	820	0.12	71 ... 132	7910	7910	26100	30400	7390	2400
	300R4	453	1.1	1230	0.16	71 ... 132	8070	8070	26700	31000	7740	2400
	300R4	491	1.0	860	0.10	71 ... 132	8160	8160	27000	31400	7950	2400
	300R4	613	0.82	860	0.08	71 ... 132	8420	8420	27900	32400	8000	2400
	300R4	766	0.65	860	0.07	71 ... 132	8690	8690	28800	33400	8000	2400

301 R 264

2060 Nm

n ₁ min ⁻¹		i	n ₂ min ⁻¹	M _{n2} Nm	P _{n1} kW	P (IEC)	Rn ₂ [N]					M _{2 max} Nm
							MC	MZ	HC/PC	HZ/PZ	FZ	
1500	301R2	7.13	210	1040	15.0	71 ... 132	2360	2360	8620	9420	1350	3400
	301R2	8.74	172	1090	15.0	71 ... 132	2520	2520	9160	10000	1440	3400
	301R2	11.8	127	1150	15.0	71 ... 132	2790	2790	10000	11000	1590	3400
	301R2	14.8	102	940	10.6	71 ... 132	3000	3000	10700	11700	1710	3400
	301R2	18.5	81	740	6.7	71 ... 132	3230	3230	11500	12500	1850	3400
	301R3	24.8	60	1390	9.7	71 ... 132	3570	3570	12500	13700	2040	3400
	301R3	30.4	49	1580	8.9	71 ... 132	3820	3820	13300	14600	2180	3400
	301R3	37.3	40	1600	7.4	71 ... 132	4090	4090	14200	15500	2330	3400
	301R3	41.2	36	1300	5.4	71 ... 132	4220	4220	14600	15900	2410	3400
	301R3	50.4	29.8	1630	5.6	71 ... 132	4520	4520	15500	16900	2580	3400
	301R3	62.9	23.8	1650	4.5	71 ... 132	4870	4870	16600	18100	2780	3400
	301R3	68.2	22.0	1300	3.3	71 ... 132	5000	5000	17000	18600	2860	3400
	301R3	78.7	19.1	1570	3.4	71 ... 132	5240	5240	17700	19400	2990	3400
	301R3	85.2	17.6	1300	2.6	71 ... 132	5380	5380	18100	19800	3070	3400
	301R3	106	14.1	1300	2.1	71 ... 132	5800	5800	19400	21200	3310	3400
	301R3	133	11.3	1150	1.5	71 ... 132	6240	6240	20700	22700	3570	3400
	301R4	106	14.2	1700	2.8	71 ... 132	5790	5790	19400	21200	3310	3400
	301R4	130	11.6	1720	2.3	71 ... 132	6190	6190	20600	22500	3540	3400
	301R4	143	10.5	1300	1.6	71 ... 132	6400	6400	21200	23200	3660	3400
	301R4	159	9.4	1740	1.9	71 ... 132	6500	6500	21500	23500	3780	3400

B

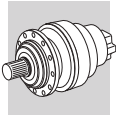

301 R



2060 Nm

n ₁ min ⁻¹	i	n ₂ min ⁻¹	M _{n2} Nm	P _{n1} kW	P (IEC)	Rn ₂ [N]					M _{2 max} Nm	
						MC	MZ	HC/PC	HZ/PZ	FZ		
1500	301R4	175	8.5	1770	1.8	71 ... 132	6500	6500	21500	23500	3910	3400
	301R4	215	7.0	1820	1.5	71 ... 132	6500	6500	21500	23500	4190	3400
	301R4	237	6.3	1300	0.97	71 ... 132	6500	6500	21500	23500	4330	3400
	301R4	268	5.6	1870	1.2	71 ... 132	6500	6500	21500	23500	4510	3400
	301R4	291	5.2	1890	1.2	71 ... 132	6500	6500	21500	23500	4630	3400
	301R4	363	4.1	1960	0.96	71 ... 132	6680	6680	22100	24100	4990	3400
	301R4	394	3.8	1360	0.61	71 ... 132	6760	6760	22400	24400	5120	3400
	301R4	453	3.3	1930	0.76	71 ... 132	6890	6890	22800	24900	5370	3400
	301R4	491	3.1	1410	0.51	71 ... 132	6970	6970	23100	25200	5510	3400
	301R4	613	2.4	1470	0.42	71 ... 132	7200	7200	23800	26000	5940	3400
301R4	766	2.0	1530	0.35	71 ... 132	7430	7430	24600	26900	6400	3400	
1000	301R2	7.13	140	1170	15.0	71 ... 132	2700	2700	9740	10600	1540	3400
	301R2	8.74	114	1230	15.0	71 ... 132	2880	2880	10300	11300	1650	3400
	301R2	11.8	85	1250	11.8	71 ... 132	3190	3190	11300	12400	1820	3400
	301R2	14.8	68	1050	7.9	71 ... 132	3440	3440	12100	13200	1960	3400
	301R2	18.5	54	740	4.5	71 ... 132	3700	3700	12900	14200	2110	3400
	301R3	24.8	40	1430	6.6	71 ... 132	4090	4090	14200	15500	2330	3400
	301R3	30.4	33	1620	6.1	71 ... 132	4370	4370	15000	16400	2500	3400
	301R3	37.3	26.8	1640	5.0	71 ... 132	4680	4680	16000	17500	2670	3400
	301R3	41.2	24.3	1300	3.6	71 ... 132	4840	4840	16500	18000	2760	3400
	301R3	50.4	19.8	1660	3.8	71 ... 132	5170	5170	17500	19100	2960	3400
	301R3	62.9	15.9	1690	3.1	71 ... 132	5570	5570	18700	20500	3180	3400
	301R3	68.2	14.7	1300	2.2	71 ... 132	5720	5720	19200	21000	3270	3400
	301R3	78.7	12.7	1590	2.3	71 ... 132	6000	6000	20000	21900	3430	3400
	301R3	85.2	11.7	1300	1.8	71 ... 132	6160	6160	20500	22400	3520	3400
	301R3	106	9.4	1300	1.4	71 ... 132	6500	6500	21500	23500	3790	3400
	301R3	133	7.5	1150	0.99	71 ... 132	6500	6500	21500	23500	4080	3400
	301R4	106	9.4	1740	1.9	71 ... 132	6500	6500	21500	23500	3780	3400
	301R4	130	7.7	1790	1.6	71 ... 132	6500	6500	21500	23500	4050	3400
	301R4	143	7.0	1300	1.1	71 ... 132	6500	6500	21500	23500	4190	3400
	301R4	159	6.3	1840	1.4	71 ... 132	6500	6500	21500	23500	4330	3400
	301R4	175	5.7	1870	1.3	71 ... 132	6500	6500	21500	23500	4480	3400
	301R4	215	4.7	1920	1.1	71 ... 132	6570	6570	21700	23700	4790	3400
	301R4	237	4.2	1340	0.67	71 ... 132	6660	6660	22000	24100	4950	3400
	301R4	268	3.7	2000	0.88	71 ... 132	6780	6780	22400	24500	5160	3400
	301R4	291	3.4	2030	0.82	71 ... 132	6860	6860	22700	24800	5300	3400
	301R4	363	2.8	2100	0.69	71 ... 132	7080	7080	23400	25600	5710	3400
	301R4	394	2.5	1460	0.44	71 ... 132	7160	7160	23700	25900	5860	3400
	301R4	453	2.2	2000	0.52	71 ... 132	7310	7310	24200	26400	6140	3400
	301R4	491	2.0	1510	0.36	71 ... 132	7390	7390	24400	26700	6310	3400
	301R4	613	1.6	1580	0.30	71 ... 132	7630	7630	25200	27600	6800	3400
301R4	766	1.3	1640	0.25	71 ... 132	7880	7880	26000	28500	7320	3400	
500	301R2	7.13	70	1370	10.6	71 ... 132	3400	3400	12000	13100	1940	3400
	301R2	8.74	57	1520	9.7	71 ... 132	3630	3630	12700	13900	2080	3400
	301R2	11.8	42	1300	6.1	71 ... 132	4020	4020	14000	15200	2300	3400
	301R2	14.8	34	1150	4.3	71 ... 132	4330	4330	14900	16300	2470	3400
	301R2	18.5	27.1	740	2.2	71 ... 132	4660	4660	15900	17400	2660	3400
	301R3	24.8	20.1	1430	3.3	71 ... 132	5150	5150	17400	19000	2940	3400
	301R3	30.4	16.4	1680	3.2	71 ... 132	5510	5510	18500	20200	3150	3400
	301R3	37.3	13.4	1700	2.6	71 ... 132	5890	5890	19700	21500	3370	3400
	301R3	41.2	12.1	1300	1.8	71 ... 132	6090	6090	20300	22200	3480	3400
	301R3	50.4	9.9	1730	2.0	71 ... 132	6500	6500	21500	23500	3720	3400
	301R3	62.9	7.9	1760	1.6	71 ... 132	6500	6500	21500	23500	4010	3400
	301R3	68.2	7.3	1300	1.1	71 ... 132	6500	6500	21500	23500	4120	3400
	301R3	78.7	6.4	1600	1.2	71 ... 132	6500	6500	21500	23500	4320	3400
	301R3	85.2	5.9	1300	0.88	71 ... 132	6500	6500	21500	23500	4430	3400
	301R3	106	4.7	1310	0.71	71 ... 132	6560	6560	21700	23700	4780	3400
	301R3	133	3.8	1150	0.50	71 ... 132	6770	6770	22400	24500	5140	3400
	301R4	106	4.7	1920	1.1	71 ... 132	6550	6550	21700	23700	4770	3400

B

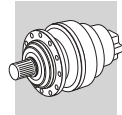

301 R 264

2060 Nm

n ₁ min ⁻¹		i	n ₂ min ⁻¹	M _{n2} Nm	P _{n1} kW	P (IEC)	Rn ₂ [N]					M ₂ max Nm
							MC	MZ	HC/PC	HZ/PZ	FZ	
500	301R4	130	3.9	1990	0.91	71 ... 132	6750	6750	22300	24400	5100	3400
	301R4	143	3.5	1380	0.57	71 ... 132	6840	6840	22600	24700	5270	3400
	301R4	159	3.1	2060	0.77	71 ... 132	6940	6940	23000	25100	5460	3400
	301R4	175	2.8	2090	0.71	71 ... 132	7040	7040	23300	25500	5640	3400
	301R4	215	2.3	2160	0.60	71 ... 132	7250	7250	24000	26200	6040	3400
	301R4	237	2.1	1510	0.37	71 ... 132	7350	7350	24300	26600	6240	3400
	301R4	268	1.9	2240	0.49	71 ... 132	7480	7480	24800	27100	6500	3400
	301R4	291	1.7	2270	0.46	71 ... 132	7570	7570	25000	27400	6680	3400
	301R4	363	1.4	2340	0.38	71 ... 132	7810	7810	25800	28300	7190	3400
	301R4	394	1.3	1650	0.25	71 ... 132	7910	7910	26100	28600	7390	3400
	301R4	453	1.1	2000	0.26	71 ... 132	8070	8070	26700	29200	7740	3400
	301R4	491	1.0	1710	0.21	71 ... 132	8160	8160	27000	29500	7950	3400
	301R4	613	0.82	1720	0.17	71 ... 132	8420	8420	27900	30400	8000	3400
	301R4	766	0.65	1720	0.13	71 ... 132	8690	8690	28800	31400	8000	3400

303 R 274

2970 Nm

n ₁ min ⁻¹		i	n ₂ min ⁻¹	M _{n2} Nm	P _{n1} kW	P (IEC)	Rn ₂ [N]					M ₂ max Nm	
							MC	MZ	HC/PC	HZ/PZ	FZ		
1500	303R2	9.23	163	1680	30	71 ... 132	8290	9470	17500	20800	4400	5200	
	303R2	10.9	138	1900	29.1	71 ... 132	8760	10000	18400	21900	4650	5200	
	303R2	13.7	110	1970	24.1	71 ... 132	9450	10800	19700	23400	5010	5200	
	303R2	15.9	94	1820	19.1	71 ... 132	9940	11400	20700	24500	5270	5200	
	303R2	19.2	78	1550	13.5	71 ... 132	10600	12100	21900	25900	5620	5200	
	303R2	24.8	61	860	5.8	71 ... 132	11500	13200	23600	28000	6110	5200	
	303R3	25.7	58	2030	13.6	71 ... 132	11700	13300	23900	28300	6190	5200	
	303R3	31.5	48	2110	11.5	71 ... 132	12500	14300	25300	30000	6620	5200	
	303R3	37.1	40	2390	11.1	71 ... 132	13200	15100	26600	31600	7000	5200	
	303R3	42.6	35	2070	8.4	71 ... 132	13800	15800	27800	32900	7320	5200	
	303R3	46.6	32	2160	8.0	71 ... 132	14200	16300	28500	33800	7550	5200	
	303R3	50.3	29.8	2380	8.2	71 ... 132	14600	16700	29200	34600	7740	5200	
	303R3	54.2	27.7	1820	5.8	71 ... 132	15000	17100	29800	35400	7930	5200	
	303R3	63.1	23.8	2170	5.9	71 ... 132	15700	18000	31200	37000	8350	5200	
	303R3	73.3	20.5	1820	4.3	71 ... 132	16500	18900	32700	38700	8780	5200	
	303R3	78.7	19.1	2180	4.8	71 ... 132	16900	19400	33400	39600	8990	5200	
	303R3	91.5	16.4	1820	3.4	71 ... 132	17800	20400	34900	41400	9450	5200	
	303R3	114	13.1	1820	2.7	71 ... 132	19200	21900	37300	44300	10200	5200	
	303R4	129	11.6	2620	3.6	71 ... 132	20000	22800	38700	45900	10600	5200	
	303R4	148	10.1	2310	2.8	71 ... 132	20900	23900	40400	47800	11100	5200	
	303R4	158	9.5	2660	3.0	71 ... 132	21000	24000	40500	48000	11300	5200	
	303R4	185	8.1	2310	2.2	71 ... 132	21000	24000	40500	48000	11900	5200	
	303R4	214	7.0	2730	2.3	71 ... 132	21000	24000	40500	48000	12500	5200	
	303R4	231	6.5	1830	1.4	71 ... 132	21000	24000	40500	48000	12900	5200	
	303R4	255	5.9	1840	1.3	71 ... 132	21000	24000	40500	48000	13300	5200	
	303R4	290	5.2	2650	1.6	71 ... 132	21000	24000	40500	48000	13900	5200	
	303R4	313	4.8	1850	1.1	71 ... 132	21100	24100	40700	48300	14200	5200	
	303R4	336	4.5	2270	1.2	71 ... 132	21300	24400	41200	48800	14600	5200	
	303R4	364	4.1	2310	1.1	71 ... 132	21600	24700	41600	49300	15000	5200	
	303R4	390	3.8	1930	0.88	71 ... 132	21800	24900	42000	49800	15300	5200	
	303R4	452	3.3	2250	0.88	71 ... 132	22300	25400	42900	50900	16100	5200	
	303R4	528	2.8	2030	0.68	71 ... 132	22800	26000	43900	52000	16900	5200	
	303R4	567	2.6	2430	0.76	71 ... 132	23000	26300	44400	52600	17400	5200	
	303R4	659	2.3	2110	0.57	71 ... 132	23500	26900	45300	53700	18200	5200	
	303R4	797	1.9	1820	0.41	71 ... 132	24100	27600	46600	55200	19400	5200	
	303R4	824	1.8	2200	0.47	71 ... 132	24300	27700	46800	55400	19700	5200	
	1000	303R2	9.23	108	1890	22.8	71 ... 132	9490	10800	19800	23500	5030	5200
		303R2	10.9	92	2140	21.9	71 ... 132	10000	11500	20800	24700	5320	5200
		303R2	13.7	73	2080	16.9	71 ... 132	10800	12400	22300	26400	5740	5200
		303R2	15.9	63	1820	12.7	71 ... 132	11400	13000	23300	27600	6030	5200



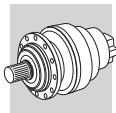

303 R



2970 Nm

B

n ₁ min ⁻¹	i	n ₂ min ⁻¹	M _{n2} Nm	P _{n1} kW	P (IEC)	Rn ₂ [N]					M _{2 max} Nm	
						MC	MZ	HC/PC	HZ/PZ	FZ		
1000	303R2	19.2	52	1640	9.5	71 ... 132	12100	13900	24700	29300	6430	5200
	303R2	24.8	40	860	3.9	71 ... 132	13200	15100	26600	31600	7000	5200
	303R3	25.7	39	2160	9.6	71 ... 132	13300	15300	26900	31900	7080	5200
	303R3	31.5	32	2160	7.9	71 ... 132	14300	16300	28600	33900	7580	5200
	303R3	37.1	26.9	2460	7.6	71 ... 132	15100	17300	30100	35700	8010	5200
	303R3	42.6	23.5	2110	5.7	71 ... 132	15800	18100	31300	37200	8380	5200
	303R3	46.6	21.5	2170	5.3	71 ... 132	16300	18600	32200	38200	8640	5200
	303R3	50.3	19.9	2470	5.6	71 ... 132	16700	19100	32900	39000	8860	5200
	303R3	54.2	18.5	1820	3.9	71 ... 132	17100	19600	33700	39900	9080	5200
	303R3	63.1	15.9	2180	4.0	71 ... 132	18000	20600	35300	41800	9550	5200
	303R3	73.3	13.6	1820	2.8	71 ... 132	18900	21600	36900	43700	10000	5200
	303R3	78.7	12.7	2190	3.2	71 ... 132	19400	22200	37700	44700	10300	5200
	303R3	91.5	10.9	1820	2.3	71 ... 132	20400	23300	39400	46700	10800	5200
	303R3	114	8.7	1820	1.8	71 ... 132	21000	24000	40500	48000	11700	5200
	303R4	129	7.7	2710	2.5	71 ... 132	21000	24000	40500	48000	12100	5200
	303R4	148	6.7	2310	1.8	71 ... 132	21000	24000	40500	48000	12700	5200
	303R4	158	6.3	2760	2.1	71 ... 132	21000	24000	40500	48000	13000	5200
	303R4	185	5.4	2310	1.5	71 ... 132	21000	24000	40500	48000	13700	5200
	303R4	214	4.7	2810	1.6	71 ... 132	21200	24200	40900	48500	14400	5200
	303R4	231	4.3	1890	0.97	71 ... 132	21400	24500	41300	49000	14700	5200
	303R4	255	3.9	1920	0.89	71 ... 132	21700	24900	41900	49700	15200	5200
	303R4	290	3.4	2680	1.1	71 ... 132	22100	25300	42700	50600	15900	5200
	303R4	313	3.2	1990	0.75	71 ... 132	22400	25600	43200	51200	16300	5200
	303R4	336	3.0	2440	0.86	71 ... 132	22600	25800	43600	51700	16700	5200
	303R4	364	2.7	2480	0.81	71 ... 132	22900	26100	44100	52300	17100	5200
	303R4	390	2.6	2070	0.63	71 ... 132	23100	26400	44600	52800	17500	5200
	303R4	452	2.2	2250	0.59	71 ... 132	23600	27000	45500	53900	18400	5200
	303R4	528	1.9	2180	0.49	71 ... 132	24100	27600	46500	55100	19400	5200
	303R4	567	1.8	2600	0.54	71 ... 132	24400	27900	47000	55700	19900	5200
	303R4	659	1.5	2270	0.41	71 ... 132	24900	28500	48000	56900	20900	5200
	303R4	797	1.3	1930	0.29	71 ... 132	25600	29200	49300	58500	22300	5200
	303R4	824	1.2	2360	0.34	71 ... 132	25700	29400	49600	58800	22500	5200
	500	303R2	9.23	54	2260	13.7	71 ... 132	12000	13700	24400	28900	6340
303R2		10.9	46	2570	13.2	71 ... 132	12600	14400	25600	30400	6700	5200
303R2		13.7	37	2150	8.8	71 ... 132	13600	15600	27400	32500	7230	5200
303R2		15.9	31	1820	6.4	71 ... 132	14300	16400	28700	34000	7600	5200
303R2		19.2	26.0	1650	4.8	71 ... 132	15300	17500	30400	36000	8100	5200
303R2		24.8	20.2	860	1.9	71 ... 132	16600	19000	32800	38900	8810	5200
303R3		25.7	19.5	2230	5.0	71 ... 132	16800	19200	33200	39300	8920	5200
303R3		31.5	15.9	2250	4.1	71 ... 132	18000	20600	35200	41800	9550	5200
303R3		37.1	13.5	2590	4.0	71 ... 132	19000	21700	37000	43900	10100	5200
303R3		42.6	11.7	2190	3.0	71 ... 132	19900	22700	38600	45700	10600	5200
303R3		46.6	10.7	2200	2.7	71 ... 132	20500	23400	39700	47000	10900	5200
303R3		50.3	9.9	2620	3.0	71 ... 132	21000	24000	40500	48000	11200	5200
303R3		54.2	9.2	1820	1.9	71 ... 132	21000	24000	40500	48000	11400	5200
303R3		63.1	7.9	2210	2.0	71 ... 132	21000	24000	40500	48000	12000	5200
303R3		73.3	6.8	1830	1.4	71 ... 132	21000	24000	40500	48000	12700	5200
303R3		78.7	6.4	2220	1.6	71 ... 132	21000	24000	40500	48000	13000	5200
303R3		91.5	5.5	1840	1.2	71 ... 132	21000	24000	40500	48000	13600	5200
303R3		114	4.4	1880	0.94	71 ... 132	21400	24500	41300	48900	14700	5200
303R4		129	3.9	2810	1.3	71 ... 132	21800	24900	42000	49800	15300	5200
303R4		148	3.4	2310	0.92	71 ... 132	22200	25400	42800	50800	16000	5200
303R4		158	3.2	2810	1.0	71 ... 132	22400	25600	43200	51300	16400	5200
303R4		185	2.7	2310	0.74	71 ... 132	22900	26200	44200	52400	17200	5200
303R4		214	2.3	2820	0.78	71 ... 132	23400	26800	45200	53500	18100	5200
303R4		231	2.2	2130	0.55	71 ... 132	23700	27000	45600	54100	18600	5200
303R4		255	2.0	2170	0.50	71 ... 132	24000	27400	46300	54900	19200	5200
303R4		290	1.7	2730	0.56	71 ... 132	24400	27900	47200	55900	20000	5200
303R4		313	1.6	2250	0.43	71 ... 132	24700	28200	47700	56500	20500	5200
303R4		336	1.5	2700	0.48	71 ... 132	25000	28500	48100	57100	21000	5200

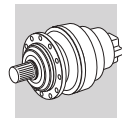

303 R 274

2970 Nm

n ₁ min ⁻¹		i	n ₂ min ⁻¹	M _{n2} Nm	P _{n1} kW	P (IEC)	Rn ₂ [N]					M ₂ max Nm
							MC	MZ	HC/PC	HZ/PZ	FZ	
500	303R4	364	1.4	2730	0.44	71 ... 132	25300	28900	48700	57700	21600	5200
	303R4	390	1.3	2340	0.35	71 ... 132	25500	29200	49200	58300	22100	5200
	303R4	452	1.1	2250	0.29	71 ... 132	26000	29800	50200	59500	23200	5200
	303R4	528	0.95	2440	0.27	71 ... 132	26600	30400	51400	60900	24000	5200
	303R4	567	0.88	2850	0.30	71 ... 132	26900	30700	51900	61500	24000	5200
	303R4	659	0.76	2440	0.22	71 ... 132	27500	31400	53000	62800	24000	5200
	303R4	797	0.63	2000	0.15	71 ... 132	28200	32300	54500	64600	24000	5200
	303R4	824	0.61	2440	0.18	71 ... 132	28400	32400	54700	64900	24000	5200

304 R 284

3960 Nm

n ₁ min ⁻¹		i	n ₂ min ⁻¹	M _{n2} Nm	P _{n1} kW	P (IEC)	Rn ₂ [N]					M ₂ max Nm
							MC	MZ	HC/PC	HZ/PZ	FZ	
1500	304R2	9.23	163	1680	30	71 ... 132	8290	9470	17500	20800	4400	6600
	304R2	10.9	138	1980	30	71 ... 132	8760	10000	18400	21900	4650	6600
	304R2	13.7	110	2490	30	71 ... 132	9450	10800	19700	23400	5010	6600
	304R2	16.8	89	2390	23.7	71 ... 132	10100	11600	21000	24900	5370	6600
	304R3	25.7	58	3020	15.0	71 ... 132	11700	13300	23900	28300	6190	7300
	304R3	31.5	48	3090	15.0	71 ... 132	12500	14300	25300	30000	6620	7300
	304R3	37.1	40	3440	15.0	71 ... 132	13200	15100	26600	31600	7000	7300
	304R3	42.6	35	3190	12.9	71 ... 132	13800	15800	27800	32900	7320	7300
	304R3	46.6	32	2850	10.5	71 ... 132	14200	16300	28500	33800	7550	7300
	304R3	50.3	29.8	3460	11.9	71 ... 132	14600	16700	29200	34600	7740	7300
	304R3	63.1	23.8	2850	7.8	71 ... 132	15700	18000	31200	37000	8350	7300
	304R3	78.7	19.1	2850	6.2	71 ... 132	16900	19400	33400	39600	8990	7300
	304R3	97.0	15.5	2390	4.2	71 ... 132	18200	20800	35500	42100	9630	7300
	304R3	121	12.4	2390	3.4	71 ... 132	19600	22400	38000	45000	10400	7300
	304R4	89.4	16.8	3330	6.6	71 ... 132	17700	20200	34700	41100	9370	7300
	304R4	109	13.7	3370	5.5	71 ... 132	18900	21600	36900	43700	10000	7300
	304R4	129	11.6	3530	4.8	71 ... 132	20000	22800	38700	45900	10600	7300
	304R4	148	10.1	3440	4.1	71 ... 132	20900	23900	40400	47800	11100	7300
	304R4	158	9.5	3550	4.0	71 ... 132	21000	24000	40500	48000	11300	7300
	304R4	185	8.1	3460	3.3	71 ... 132	21000	24000	40500	48000	11900	7300
	304R4	214	7.0	3620	3.0	71 ... 132	21000	24000	40500	48000	12500	7300
	304R4	227	6.6	3480	2.7	71 ... 132	21000	24000	40500	48000	12800	7300
	304R4	267	5.6	3660	2.4	71 ... 132	21000	24000	40500	48000	13500	7300
	304R4	290	5.2	3680	2.3	71 ... 132	21000	24000	40500	48000	13900	7300
	304R4	307	4.9	3500	2.0	71 ... 132	21100	24100	40600	48100	14100	7300
	304R4	338	4.4	2420	1.3	71 ... 132	21400	24400	41200	48800	14600	7300
	304R4	364	4.1	2940	1.4	71 ... 132	21600	24700	41600	49300	15000	7300
	304R4	414	3.6	2470	1.1	71 ... 132	22000	25100	42400	50300	15600	7300
	304R4	452	3.3	3690	1.4	71 ... 132	22300	25400	42900	50900	16100	7300
	304R4	560	2.7	2540	0.81	71 ... 132	23000	26200	44300	52500	17300	7300
	304R4	699	2.1	2630	0.67	71 ... 132	23700	27100	45700	54200	18600	7300
	1000	304R2	9.23	108	1890	22.8	71 ... 132	9490	10800	19800	23500	5030
304R2		10.9	92	2240	22.9	71 ... 132	10000	11500	20800	24700	5320	6600
304R2		13.7	73	2690	21.9	71 ... 132	10800	12400	22300	26400	5740	6600
304R2		16.8	59	2390	15.8	71 ... 132	11600	13300	23700	28100	6150	6600
304R3		25.7	39	3130	14.0	71 ... 132	13300	15300	26900	31900	7080	7300
304R3		31.5	32	3180	11.6	71 ... 132	14300	16300	28600	33900	7580	7300
304R3		37.1	26.9	3470	10.7	71 ... 132	15100	17300	30100	35700	8010	7300
304R3		42.6	23.5	3270	8.8	71 ... 132	15800	18100	31300	37200	8380	7300
304R3		46.6	21.5	2850	7.0	71 ... 132	16300	18600	32200	38200	8640	7300
304R3		50.3	19.9	3490	8.0	71 ... 132	16700	19100	32900	39000	8860	7300
304R3		63.1	15.9	2850	5.2	71 ... 132	18000	20600	35300	41800	9550	7300
304R3		78.7	12.7	2850	4.2	71 ... 132	19400	22200	37700	44700	10300	7300
304R3		97.0	10.3	2390	2.8	71 ... 132	20800	23800	40100	47600	11000	7300
304R3		121	8.2	2390	2.3	71 ... 132	21000	24000	40500	48000	11900	7300



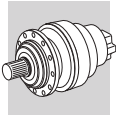

304 R

284

3960 Nm

n ₁ min ⁻¹		i	n ₂ min ⁻¹	M _{n2} Nm	P _{n1} kW	P (IEC)	Rn ₂ [N]					M ₂ max Nm
							MC	MZ	HC/PC	HZ/PZ	FZ	
1000	304R4	89.4	11.2	3420	4.5	71 ... 132	20200	23100	39200	46400	10700	7300
	304R4	109	9.1	3450	3.7	71 ... 132	21000	24000	40500	48000	11500	7300
	304R4	129	7.7	3590	3.3	71 ... 132	21000	24000	40500	48000	12100	7300
	304R4	148	6.7	3470	2.8	71 ... 132	21000	24000	40500	48000	12700	7300
	304R4	158	6.3	3640	2.7	71 ... 132	21000	24000	40500	48000	13000	7300
	304R4	185	5.4	3490	2.2	71 ... 132	21000	24000	40500	48000	13700	7300
	304R4	214	4.7	3700	2.0	71 ... 132	21200	24200	40900	48500	14400	7300
	304R4	227	4.4	3500	1.8	71 ... 132	21400	24400	41200	48900	14600	7300
	304R4	267	3.7	3720	1.6	71 ... 132	21900	25000	42200	50000	15500	7300
	304R4	290	3.4	3720	1.5	71 ... 132	22100	25300	42700	50600	15900	7300
	304R4	307	3.3	3510	1.4	71 ... 132	22300	25500	43000	51000	16200	7300
	304R4	338	3.0	2520	0.88	71 ... 132	22600	25900	43600	51700	16700	7300
	304R4	364	2.7	3140	1.0	71 ... 132	22900	26100	44100	52300	17100	7300
	304R4	414	2.4	2580	0.74	71 ... 132	23300	26600	44900	53200	17900	7300
	304R4	452	2.2	3740	0.98	71 ... 132	23600	27000	45500	53900	18400	7300
	304R4	560	1.8	2720	0.57	71 ... 132	24300	27800	46900	55600	19800	7300
	304R4	699	1.4	2830	0.48	71 ... 132	25100	28700	48400	57400	21300	7300
500	304R2	9.23	54	2330	14.1	71 ... 132	12000	13700	24400	28900	6340	6600
	304R2	10.9	46	2720	13.9	71 ... 132	12600	14400	25600	30400	6700	6600
	304R2	13.7	37	2850	11.6	71 ... 132	13600	15600	27400	32500	7230	6600
	304R2	16.8	29.7	2390	7.9	71 ... 132	14600	16700	29200	34600	7750	6600
	304R3	25.7	19.5	3290	7.3	71 ... 132	16800	19200	33200	39300	8920	7300
	304R3	31.5	15.9	3330	6.1	71 ... 132	18000	20600	35200	41800	9550	7300
	304R3	37.1	13.5	3520	5.4	71 ... 132	19000	21700	37000	43900	10100	7300
	304R3	42.6	11.7	3410	4.6	71 ... 132	19900	22700	38600	45700	10600	7300
	304R3	46.6	10.7	2850	3.5	71 ... 132	20500	23400	39700	47000	10900	7300
	304R3	50.3	9.9	3540	4.0	71 ... 132	21000	24000	40500	48000	11200	7300
	304R3	63.1	7.9	2850	2.6	71 ... 132	21000	24000	40500	48000	12000	7300
	304R3	78.7	6.4	2850	2.1	71 ... 132	21000	24000	40500	48000	13000	7300
	304R3	97.0	5.2	2390	1.4	71 ... 132	21000	24000	40500	48000	13900	7300
	304R3	121	4.1	2440	1.2	71 ... 132	21600	24700	41600	49300	15000	7300
	304R4	89.4	5.6	3490	2.3	71 ... 132	21000	24000	40500	48000	13500	7300
	304R4	109	4.6	3500	1.9	71 ... 132	21300	24300	41000	48600	14500	7300
	304R4	129	3.9	3710	1.7	71 ... 132	21800	24900	42000	49800	15300	7300
	304R4	148	3.4	3510	1.4	71 ... 132	22200	25400	42800	50800	16000	7300
	304R4	158	3.2	3730	1.4	71 ... 132	22400	25600	43200	51300	16400	7300
	304R4	185	2.7	3520	1.1	71 ... 132	22900	26200	44200	52400	17200	7300
	304R4	214	2.3	3770	1.0	71 ... 132	23400	26800	45200	53500	18100	7300
	304R4	227	2.2	3550	0.93	71 ... 132	23600	27000	45500	53900	18400	7300
	304R4	267	1.9	3820	0.84	71 ... 132	24200	27600	46600	55200	19500	7300
	304R4	290	1.7	3830	0.78	71 ... 132	24400	27900	47200	55900	20000	7300
	304R4	307	1.6	3610	0.70	71 ... 132	24600	28200	47500	56300	20400	7300
	304R4	338	1.5	2810	0.49	71 ... 132	25000	28600	48200	57100	21100	7300
	304R4	364	1.4	3540	0.58	71 ... 132	25300	28900	48700	57700	21600	7300
	304R4	414	1.2	2910	0.42	71 ... 132	25700	29400	49600	58800	22500	7300
	304R4	452	1.1	3930	0.51	71 ... 132	26000	29800	50200	59500	23200	7300
	304R4	560	0.89	3010	0.32	71 ... 132	26900	30700	51800	61400	24000	7300
	304R4	699	0.71	3010	0.25	71 ... 132	27700	31700	53500	63400	24000	7300

305 R

298

5600 Nm

n ₁ min ⁻¹		i	n ₂ min ⁻¹	M _{n2} Nm	P _{n1} kW	P (IEC)	Rn ₂ [N]					M ₂ max Nm
							MC	MZ	HC/PC	HZ/PZ	FZ	
1500	305R2	9.23	163	1680	30	71 ... 132	8290	9470	17500	20800	4400	7700
	305R2	10.9	138	1980	30	71 ... 132	8760	10000	18400	21900	4650	7700
	305R2	13.7	110	2490	30	71 ... 132	9450	10800	19700	23400	5010	7700
	305R2	15.9	94	2890	30	71 ... 132	9940	11400	20700	24500	5270	7700
	305R2	19.2	78	2860	24.9	71 ... 132	10600	12100	21900	25900	5620	7700

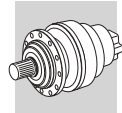

305 R



5600 Nm

n ₁ min ⁻¹	i	n ₂ min ⁻¹	M _{n2} Nm	P _{n1} kW	P (IEC)	Rn ₂ [N]					M _{2 max} Nm		
						MC	MZ	HC/PC	HZ/PZ	FZ			
1500	305R3	25.7	58	3630	15.0	71 ... 132	11700	13300	23900	28300	6190	8800	
	305R3	31.5	48	3770	15.0	71 ... 132	12500	14300	25300	30000	6620	8800	
	305R3	37.1	40	4340	15.0	71 ... 132	13200	15100	26600	31600	7000	8800	
	305R3	42.6	35	3790	15.0	71 ... 132	13800	15800	27800	32900	7320	8800	
	305R3	46.6	32	4310	15.0	71 ... 132	14200	16300	28500	33800	7550	8800	
	305R3	50.3	29.8	4410	15.0	71 ... 132	14600	16700	29200	34600	7740	8800	
	305R3	54.2	27.7	3570	11.3	71 ... 132	15000	17100	29800	35400	7930	8800	
	305R3	63.1	23.8	4330	11.8	71 ... 132	15700	18000	31200	37000	8350	8800	
	305R3	73.3	20.5	3580	8.4	71 ... 132	16500	18900	32700	38700	8780	8800	
	305R3	78.7	19.1	4350	9.5	71 ... 132	16900	19400	33400	39600	8990	8800	
	305R3	91.5	16.4	3580	6.7	71 ... 132	17800	20400	34900	41400	9450	8800	
	305R3	114	13.1	3580	5.4	71 ... 132	19200	21900	37300	44300	10200	8800	
	305R4	129	11.6	5200	7.1	71 ... 132	20000	22800	38700	45900	10600	8800	
	305R4	148	10.1	4480	5.4	71 ... 132	20900	23900	40400	47800	11100	8800	
	305R4	158	9.5	5310	6.0	71 ... 132	21000	24000	40500	48000	11300	8800	
	305R4	185	8.1	4490	4.3	71 ... 132	21000	24000	40500	48000	11900	8800	
	305R4	214	7.0	5390	4.5	71 ... 132	21000	24000	40500	48000	12500	8800	
	305R4	231	6.5	3600	2.8	71 ... 132	21000	24000	40500	48000	12900	8800	
	305R4	255	5.9	3600	2.5	71 ... 132	21000	24000	40500	48000	13300	8800	
	305R4	290	5.2	5300	3.2	71 ... 132	21000	24000	40500	48000	13900	8800	
	305R4	313	4.8	3620	2.1	71 ... 132	21100	24100	40700	48300	14200	8800	
	305R4	336	4.5	4560	2.4	71 ... 132	21300	24400	41200	48800	14600	8800	
	305R4	364	4.1	4620	2.3	71 ... 132	21600	24700	41600	49300	15000	8800	
	305R4	390	3.8	3750	1.7	71 ... 132	21800	24900	42000	49800	15300	8800	
	305R4	452	3.3	4750	1.9	71 ... 132	22300	25400	42900	50900	16100	8800	
	305R4	528	2.8	3920	1.3	71 ... 132	22800	26000	43900	52000	16900	8800	
	305R4	567	2.6	4860	1.5	71 ... 132	23000	26300	44400	52600	17400	8800	
	305R4	659	2.3	4070	1.1	71 ... 132	23500	26900	45300	53700	18200	8800	
	305R4	797	1.9	3450	0.77	71 ... 132	24100	27600	46600	55200	19400	8800	
	305R4	824	1.8	4230	0.91	71 ... 132	24300	27700	46800	55400	19700	8800	
	1000	305R2	9.23	108	1890	22.8	71 ... 132	9490	10800	19800	23500	5030	7700
		305R2	10.9	92	2240	22.9	71 ... 132	10000	11500	20800	24700	5320	7700
305R2		13.7	73	2810	22.9	71 ... 132	10800	12400	22300	26400	5740	7700	
305R2		15.9	63	3270	22.9	71 ... 132	11400	13000	23300	27600	6030	7700	
305R2		19.2	52	2990	17.3	71 ... 132	12100	13900	24700	29300	6430	7700	
305R3		25.7	39	3900	15.0	71 ... 132	13300	15300	26900	31900	7080	8800	
305R3		31.5	32	3950	14.4	71 ... 132	14300	16300	28600	33900	7580	8800	
305R3		37.1	26.9	4600	14.2	71 ... 132	15100	17300	30100	35700	8010	8800	
305R3		42.6	23.5	3990	10.7	71 ... 132	15800	18100	31300	37200	8380	8800	
305R3		46.6	21.5	4340	10.7	71 ... 132	16300	18600	32200	38200	8640	8800	
305R3		50.3	19.9	4700	10.7	71 ... 132	16700	19100	32900	39000	8860	8800	
305R3		54.2	18.5	3580	7.6	71 ... 132	17100	19600	33700	39900	9080	8800	
305R3		63.1	15.9	4370	7.9	71 ... 132	18000	20600	35300	41800	9550	8800	
305R3		73.3	13.6	3590	5.6	71 ... 132	18900	21600	36900	43700	10000	8800	
305R3		78.7	12.7	4380	6.4	71 ... 132	19400	22200	37700	44700	10300	8800	
305R3		91.5	10.9	3600	4.5	71 ... 132	20400	23300	39400	46700	10800	8800	
305R3		114	8.7	3600	3.6	71 ... 132	21000	24000	40500	48000	11700	8800	
305R4		129	7.7	5370	4.9	71 ... 132	21000	24000	40500	48000	12100	8800	
305R4		148	6.7	4490	3.6	71 ... 132	21000	24000	40500	48000	12700	8800	
305R4		158	6.3	5420	4.0	71 ... 132	21000	24000	40500	48000	13000	8800	
305R4		185	5.4	4490	2.9	71 ... 132	21000	24000	40500	48000	13700	8800	
305R4		214	4.7	5480	3.0	71 ... 132	21200	24200	40900	48500	14400	8800	
305R4		231	4.3	3680	1.9	71 ... 132	21400	24500	41300	49000	14700	8800	
305R4		255	3.9	3740	1.7	71 ... 132	21700	24900	41900	49700	15200	8800	
305R4		290	3.4	5350	2.2	71 ... 132	22100	25300	42700	50600	15900	8800	
305R4		313	3.2	3850	1.5	71 ... 132	22400	25600	43200	51200	16300	8800	
305R4		336	3.0	4890	1.7	71 ... 132	22600	25800	43600	51700	16700	8800	
305R4		364	2.7	4960	1.6	71 ... 132	22900	26100	44100	52300	17100	8800	
305R4		390	2.6	3980	1.2	71 ... 132	23100	26400	44600	52800	17500	8800	
305R4		452	2.2	4750	1.2	71 ... 132	23600	27000	45500	53900	18400	8800	
305R4		528	1.9	4200	0.94	71 ... 132	24100	27600	46500	55100	19400	8800	

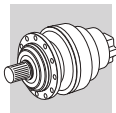

B



305 R





5600 Nm

n ₁ min ⁻¹		i	n ₂ min ⁻¹	M _{n2} Nm	P _{n1} kW	P (IEC) 	Rn ₂ [N]					M ₂ max Nm
							MC	MZ	HC/PC	HZ/PZ	FZ	
1000	305R4	567	1.8	5160	1.1	71 ... 132	24400	27900	47000	55700	19900	8800
	305R4	659	1.5	4360	0.78	71 ... 132	24900	28500	48000	56900	20900	8800
	305R4	797	1.3	3670	0.54	71 ... 132	25600	29200	49300	58500	22300	8800
	305R4	824	1.2	4530	0.65	71 ... 132	25700	29400	49600	58800	22500	8800
500	305R2	9.23	54	2330	14.1	71 ... 132	12000	13700	24400	28900	6340	7700
	305R2	10.9	46	2750	14.0	71 ... 132	12600	14400	25600	30400	6700	7700
	305R2	13.7	37	3340	13.6	71 ... 132	13600	15600	27400	32500	7230	7700
	305R2	15.9	31	3530	12.4	71 ... 132	14300	16400	28700	34000	7600	7700
	305R2	19.2	26	3040	8.8	71 ... 132	15300	17500	30400	36000	8100	7700
	305R3	25.7	19.5	4190	9.4	71 ... 132	16800	19200	33200	39300	8920	8800
	305R3	31.5	15.9	4260	7.8	71 ... 132	18000	20600	35200	41800	9550	8800
	305R3	37.1	13.5	5080	7.8	71 ... 132	19000	21700	37000	43900	10100	8800
	305R3	42.6	11.7	4340	5.9	71 ... 132	19900	22700	38600	45700	10600	8800
	305R3	46.6	10.7	4390	5.4	71 ... 132	20500	23400	39700	47000	10900	8800
	305R3	50.3	9.9	5230	6.0	71 ... 132	21000	24000	40500	48000	11200	8800
	305R3	54.2	9.2	3600	3.8	71 ... 132	21000	24000	40500	48000	11400	8800
	305R3	63.1	7.9	4420	4.0	71 ... 132	21000	24000	40500	48000	12000	8800
	305R3	73.3	6.8	3600	2.8	71 ... 132	21000	24000	40500	48000	12700	8800
	305R3	78.7	6.4	4450	3.2	71 ... 132	21000	24000	40500	48000	13000	8800
	305R3	91.5	5.5	3600	2.3	71 ... 132	21000	24000	40500	48000	13600	8800
	305R3	114	4.4	3670	1.8	71 ... 132	21400	24500	41300	48900	14700	8800
	305R4	129	3.9	5480	2.5	71 ... 132	21800	24900	42000	49800	15300	8800
	305R4	148	3.4	4490	1.8	71 ... 132	22200	25400	42800	50800	16000	8800
	305R4	158	3.2	5490	2.1	71 ... 132	22400	25600	43200	51300	16400	8800
	305R4	185	2.7	4490	1.4	71 ... 132	22900	26200	44200	52400	17200	8800
	305R4	214	2.3	5520	1.5	71 ... 132	23400	26800	45200	53500	18100	8800
	305R4	231	2.2	4100	1.1	71 ... 132	23700	27000	45600	54100	18600	8800
	305R4	255	2.0	4170	0.97	71 ... 132	24000	27400	46300	54900	19200	8800
	305R4	290	1.7	5450	1.1	71 ... 132	24400	27900	47200	55900	20000	8800
	305R4	313	1.6	4320	0.82	71 ... 132	24700	28200	47700	56500	20500	8800
	305R4	336	1.5	5350	0.94	71 ... 132	25000	28500	48100	57100	21000	8800
	305R4	364	1.4	5400	0.88	71 ... 132	25300	28900	48700	57700	21600	8800
	305R4	390	1.3	4490	0.68	71 ... 132	25500	29200	49200	58300	22100	8800
	305R4	452	1.1	4750	0.62	71 ... 132	26000	29800	50200	59500	23200	8800
	305R4	528	0.95	4690	0.53	71 ... 132	26600	30400	51400	60900	24000	8800
	305R4	567	0.88	5600	0.58	71 ... 132	26900	30700	51900	61500	24000	8800
	305R4	659	0.76	4690	0.42	71 ... 132	27500	31400	53000	62800	24000	8800
	305R4	797	0.63	3800	0.28	71 ... 132	28200	32300	54500	64600	24000	8800
305R4	824	0.61	4690	0.34	71 ... 132	28400	32400	54700	64900	24000	8800	

306 R



7300 Nm

n ₁ min ⁻¹		i	n ₂ min ⁻¹	M _{n2} Nm	P _{n1} kW	P (IEC) 	Rn ₂ [N]					M ₂ max Nm
							MC	MZ	HC/PC	HZ/PZ	FZ	
1500	306R2	9.23	163	1680	30	71 ... 160	9870	11200	24700	28500	6410	12000
	306R2	10.9	138	1980	30	71 ... 160	10400	11900	26000	30000	6780	12000
	306R2	13.7	110	2490	30	71 ... 160	11200	12800	27800	32100	7310	12000
	306R2	15.9	94	2890	30	71 ... 160	11800	13500	29100	33600	7690	12000
306R2	19.2	78	3490	30	71 ... 160	12600	14400	30800	35500	8190	12000	
306R3	33.2	45	5810	30	71 ... 160	15100	17200	36300	41900	9830	14900	
306R3	39.2	38	6550	28.8	71 ... 160	16000	18200	38100	44000	10400	14900	
306R3	46.3	32	7510	27.9	71 ... 160	16900	19300	40100	46200	11000	14900	
306R3	58.1	25.8	7580	22.5	71 ... 160	18200	20800	42900	49500	11800	14900	
306R3	67.5	22.2	7090	18.1	71 ... 160	19200	21800	44900	51800	12500	14900	
306R3	72.9	20.6	7420	17.5	71 ... 160	19700	22400	45900	53000	12800	14900	
306R3	84.7	17.7	7530	15.3	71 ... 160	20700	23600	48000	55400	13400	14900	
306R3	98.5	15.2	6490	11.3	71 ... 160	21700	24800	50200	58000	14100	14900	
306R3	119	12.6	6490	9.4	71 ... 160	23200	26400	53200	61400	15000	14900	

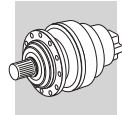

306 R



7300 Nm

n ₁ min ⁻¹	i	n ₂ min ⁻¹	M _{n2} Nm	P _{n1} kW	P (IEC)	Rn ₂ [N]					M _{2 max} Nm	
						MC	MZ	HC/PC	HZ/PZ	FZ		
1500	306R3	144	10.4	5490	6.6	71 ... 160	24700	28100	56300	65000	16000	14900
	306R4	158	9.5	9620	10.8	71 ... 160	25000	28500	57000	65800	16500	14900
	306R4	168	8.9	7560	8.0	71 ... 160	25000	28500	57000	65800	16900	14900
	306R4	181	8.3	9450	9.3	71 ... 160	25000	28500	57000	65800	17300	14900
	306R4	214	7.0	9730	8.1	71 ... 160	25000	28500	57000	65800	18300	14900
	306R4	230	6.5	7590	5.8	71 ... 160	25000	28500	57000	65800	18700	14900
	306R4	249	6.0	8200	5.9	71 ... 160	25000	28500	57000	65800	19200	14900
	306R4	289	5.2	8280	5.1	71 ... 160	25000	28500	57000	65800	20200	14900
	306R4	312	4.8	7590	4.3	71 ... 160	25100	28700	57300	66200	20700	14900
	306R4	389	3.9	7590	3.5	71 ... 160	25900	29600	59200	68300	22300	14900
	306R4	420	3.6	8790	3.7	71 ... 160	26200	29900	59800	69000	22900	14900
	306R4	455	3.3	7020	2.7	71 ... 160	26500	30200	60500	69800	23500	14900
	306R4	488	3.1	9020	3.3	71 ... 160	26800	30600	61100	70500	24100	14900
	306R4	550	2.7	7260	2.3	71 ... 160	27300	31100	62200	71800	25100	14900
	306R4	590	2.5	8480	2.5	71 ... 160	27500	31400	62800	72500	25600	14900
	306R4	665	2.3	6010	1.6	71 ... 160	28000	31900	63900	73700	26700	14900
	306R4	830	1.8	6270	1.3	71 ... 160	28900	33000	65900	76100	28700	14900
1000	306R2	9.23	108	1890	22.8	71 ... 160	11300	12900	27900	32200	7340	12000
	306R2	10.9	92	2240	22.9	71 ... 160	11900	13600	29300	33800	7760	12000
	306R2	13.7	73	2810	22.9	71 ... 160	12900	14700	31400	36200	8370	12000
	306R2	15.9	63	3270	22.9	71 ... 160	13500	15400	32800	37900	8800	12000
	306R2	19.2	52	3940	22.8	71 ... 160	14400	16400	34800	40100	9380	12000
	306R3	33.2	30	6330	21.9	71 ... 160	17300	19700	41000	47300	11300	14900
	306R3	39.2	25.5	7280	21.3	71 ... 160	18300	20900	43000	49700	11900	14900
	306R3	46.3	21.6	8170	20.3	71 ... 160	19300	22000	45200	52200	12600	14900
	306R3	58.1	17.2	8200	16.2	71 ... 160	20900	23800	48400	55900	13600	14900
	306R3	67.5	14.8	7340	12.5	71 ... 160	21900	25000	50700	58500	14300	14900
	306R3	72.9	13.7	7710	12.1	71 ... 160	22500	25600	51800	59800	14600	14900
	306R3	84.7	11.8	7820	10.6	71 ... 160	23700	27000	54200	62600	15400	14900
	306R3	98.5	10.2	6500	7.6	71 ... 160	24900	28400	56700	65500	16200	14900
	306R3	119	8.4	6510	6.3	71 ... 160	25000	28500	57000	65800	17200	14900
	306R3	144	6.9	5500	4.4	71 ... 160	25000	28500	57000	65800	18400	14900
	306R4	158	6.3	9760	7.3	71 ... 160	25000	28500	57000	65800	18900	14900
	306R4	168	6.0	7660	5.4	71 ... 160	25000	28500	57000	65800	19300	14900
	306R4	181	5.5	9450	6.2	71 ... 160	25000	28500	57000	65800	19800	14900
	306R4	214	4.7	9850	5.5	71 ... 160	25200	28800	57500	66400	20900	14900
	306R4	230	4.3	7590	3.9	71 ... 160	25500	29100	58200	67100	21500	14900
	306R4	249	4.0	8620	4.1	71 ... 160	25800	29400	58800	67900	22000	14900
	306R4	289	3.5	8840	3.6	71 ... 160	26300	30000	60100	69400	23100	14900
	306R4	312	3.2	7590	2.9	71 ... 160	26600	30400	60700	70100	23700	14900
	306R4	389	2.6	7590	2.3	71 ... 160	27500	31300	62700	72400	25500	14900
	306R4	420	2.4	9390	2.6	71 ... 160	27800	31700	63400	73200	26200	14900
	306R4	455	2.2	7530	2.0	71 ... 160	28100	32000	64100	74000	26900	14900
	306R4	488	2.0	9390	2.3	71 ... 160	28400	32400	64700	74700	27600	14900
	306R4	550	1.8	7740	1.7	71 ... 160	28900	32900	65900	76000	28700	14900
	306R4	590	1.7	8910	1.8	71 ... 160	29200	33300	66500	76800	29400	14900
	306R4	665	1.5	6490	1.2	71 ... 160	29700	33800	67700	78100	30600	14900
	306R4	830	1.2	6760	0.96	71 ... 160	30600	34900	69900	80600	32900	14900
500	306R2	9.23	54	2330	14.1	71 ... 160	14200	16200	34300	39600	9250	12000
	306R2	10.9	46	2750	14.0	71 ... 160	15000	17100	36100	41700	9770	12000
	306R2	13.7	37	3460	14.1	71 ... 160	16200	18500	38600	44600	10500	12000
	306R2	15.9	31	4020	14.1	71 ... 160	17100	19400	40400	46600	11100	12000
	306R2	19.2	26	4510	13.1	71 ... 160	18200	20700	42800	49400	11800	12000
	306R3	33.2	15.1	7350	12.7	71 ... 160	21800	24900	50400	58200	14200	14900
	306R3	39.2	12.8	8730	12.8	71 ... 160	23100	26300	53000	61200	15000	14900
	306R3	46.3	10.8	9450	11.7	71 ... 160	24400	27800	55700	64300	15800	14900
	306R3	58.1	8.6	9100	9.0	71 ... 160	25000	28500	57000	65800	17100	14900
	306R3	67.5	7.4	7590	6.4	71 ... 160	25000	28500	57000	65800	18000	14900
	306R3	72.9	6.9	8140	6.4	71 ... 160	25000	28500	57000	65800	18400	14900

B

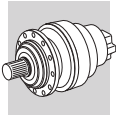

306 R



7300 Nm

n ₁ min ⁻¹		i	n ₂ min ⁻¹	M _{n2} Nm	P _{n1} kW	P (IEC)	Rn ₂ [N]					M _{2 max} Nm
							MC	MZ	HC/PC	HZ/PZ	FZ	
500	306R3	84.7	5.9	8210	5.6	71 ... 160	25000	28500	57000	65800	19400	14900
	306R3	98.5	5.1	6530	3.8	71 ... 160	25000	28500	57000	65800	20400	14900
	306R3	119	4.2	6730	3.2	71 ... 160	25600	29200	58400	67500	21700	14900
	306R3	144	3.5	5710	2.3	71 ... 160	26300	30000	60100	69300	23100	14900
	306R4	158	3.2	9850	3.7	71 ... 160	26700	30400	60800	70200	23800	14900
	306R4	168	3.0	7700	2.7	71 ... 160	26900	30700	61400	70800	24300	14900
	306R4	181	2.8	9450	3.1	71 ... 160	27200	31000	62000	71600	24900	14900
	306R4	214	2.3	9890	2.7	71 ... 160	27900	31800	63500	73300	26400	14900
	306R4	230	2.2	7640	2.0	71 ... 160	28200	32100	64200	74100	27000	14900
	306R4	249	2.0	9520	2.3	71 ... 160	28500	32500	64900	74900	27700	14900
	306R4	289	1.7	9430	1.9	71 ... 160	29100	33200	66300	76600	29200	14900
	306R4	312	1.6	7730	1.5	71 ... 160	29400	33500	67000	77400	29900	14900
	306R4	389	1.3	8240	1.3	71 ... 160	30400	34600	69200	79900	32200	14900
	306R4	420	1.2	9940	1.4	71 ... 160	30700	35000	70000	80800	33000	14900
	306R4	455	1.1	8490	1.1	71 ... 160	31000	35400	70800	81700	33900	14900
	306R4	488	1.0	9530	1.2	71 ... 160	31400	35700	71500	82500	34700	14900
	306R4	550	0.91	8500	0.91	71 ... 160	31900	36400	72700	83900	35000	14900
	306R4	590	0.85	9500	0.95	71 ... 160	32200	36700	73500	84800	35000	14900
	306R4	665	0.75	7000	0.62	71 ... 160	32800	37400	74700	86300	35000	14900
	306R4	830	0.60	7000	0.50	71 ... 160	33800	38600	77100	89000	35000	14900

307 R



14000 Nm

n ₁ min ⁻¹		i	n ₂ min ⁻¹	M _{n2} Nm	P _{n1} kW	P (IEC)	Rn ₂ [N]					M _{2 max} Nm
							MC	MZ	HC/PC	HZ/PZ	FZ	
1500	307R2	13.0	116	5110	66	132 ... 200	13300	16600	32400	42600	9230	18600
	307R2	15.5	97	6090	66	132 ... 200	14100	17600	34100	44900	9790	21000
	307R2	19.8	76	7820	66	132 ... 200	15300	19100	36800	48400	10600	21000
	307R2	23.5	64	7970	57	132 ... 200	16200	20200	38700	50900	11300	21000
	307R3	31.6	47	5570	30	71 ... 160	17900	22300	42300	55700	12400	18600
	307R3	37.7	40	6650	30	71 ... 160	18900	23700	44600	58700	13200	21000
	307R3	44.6	34	7860	30	71 ... 160	20000	25000	46900	61700	13900	21000
	307R3	55.9	26.8	9860	30	71 ... 160	21600	27000	50200	66000	15000	21000
	307R3	65.0	23.1	11000	29.1	71 ... 160	22700	28400	52500	69100	15800	21000
	307R3	71.8	20.9	10100	24.2	71 ... 160	23500	29300	54100	71200	16300	21000
	307R3	78.6	19.1	11100	24.3	71 ... 160	24200	30200	55600	73200	16800	21000
	307R3	83.4	18.0	10200	21.1	71 ... 160	24700	30800	56600	74500	17200	21000
	307R3	99.0	15.2	8580	14.9	71 ... 160	26100	32600	59600	78400	18200	21000
	307R3	120	12.5	8630	12.4	71 ... 160	27800	34800	63100	83000	19400	21000
	307R4	152	9.9	13500	15.0	71 ... 160	30000	37500	67500	88800	21000	21000
	307R4	165	9.1	10900	11.7	71 ... 160	30000	37500	67500	88800	21600	21000
	307R4	191	7.9	14000	13.0	71 ... 160	30000	37500	67500	88800	22600	21000
	307R4	206	7.3	14100	12.2	71 ... 160	30000	37500	67500	88800	23200	21000
	307R4	232	6.5	11100	8.5	71 ... 160	30000	37500	67500	88800	24200	21000
	307R4	258	5.8	14600	10.0	71 ... 160	30000	37500	67500	88800	25000	21000
307R4	284	5.3	11300	7.0	71 ... 160	30000	37500	67500	88800	25900	21000	
307R4	300	5.0	14000	8.3	71 ... 160	30000	37500	67500	88800	26300	21000	
307R4	331	4.5	11500	6.2	71 ... 160	30400	38000	68500	90100	27200	21000	
307R4	363	4.1	12300	6.0	71 ... 160	30800	38500	69400	91200	28000	21000	
307R4	413	3.6	11900	5.1	71 ... 160	31400	39300	70700	93000	29300	21000	
307R4	453	3.3	13400	5.3	71 ... 160	31800	39800	71600	94200	30200	21000	
307R4	490	3.1	9330	3.4	71 ... 160	32200	40200	72400	95300	31000	21000	
307R4	581	2.6	12600	3.9	71 ... 160	33000	41200	74200	97600	32800	21000	
307R4	690	2.2	9800	2.5	71 ... 160	33800	42200	76000	100000	34700	21000	
1000	307R2	13.0	77	5770	50	132 ... 200	15200	19000	36600	48100	10600	18600
	307R2	15.5	65	6880	50	132 ... 200	16100	20100	38500	50700	11200	21000
	307R2	19.8	50	8830	50	132 ... 200	17500	21900	41500	54700	12200	21000
	307R2	23.5	42	8290	39	132 ... 200	18500	23200	43700	57500	12900	21000

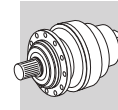

307 R



14000 Nm

n ₁ min ⁻¹	i	n ₂ min ⁻¹	M _{n2} Nm	P _{n1} kW	P (IEC)	Rn ₂ [N]					M _{2 max} Nm	
						MC	MZ	HC/PC	HZ/PZ	FZ		
1000	307R3	31.6	32	6180	22.4	71 ... 160	20400	25600	47800	62900	14200	18600
	307R3	37.7	26.5	7510	22.8	71 ... 160	21700	27100	50400	66300	15100	21000
	307R3	44.6	22.4	8870	22.9	71 ... 160	22900	28600	53000	69700	16000	21000
	307R3	55.9	17.9	11100	22.9	71 ... 160	24700	30900	56700	74600	17200	21000
	307R3	65.0	15.4	12200	21.4	71 ... 160	26000	32500	59300	78000	18100	21000
	307R3	71.8	13.9	10500	16.7	71 ... 160	26900	33600	61100	80400	18700	21000
	307R3	78.6	12.7	11800	17.3	71 ... 160	27700	34600	62800	82600	19300	21000
	307R3	83.4	12.0	10600	14.6	71 ... 160	28200	35300	63900	84100	19700	21000
	307R3	99.0	10.1	8700	10.1	71 ... 160	29900	37400	67300	88500	20800	21000
	307R3	120	8.4	8700	8.3	71 ... 160	30000	37500	67500	88800	22200	21000
	307R4	152	6.6	14300	11.2	71 ... 160	30000	37500	67500	88800	24000	21000
	307R4	165	6.1	11200	8.0	71 ... 160	30000	37500	67500	88800	24700	21000
	307R4	191	5.2	14800	9.2	71 ... 160	30000	37500	67500	88800	25900	21000
	307R4	206	4.9	14900	8.6	71 ... 160	30100	37600	67800	89200	26600	21000
	307R4	232	4.3	11600	5.9	71 ... 160	30600	38300	69000	90700	27700	21000
	307R4	258	3.9	14900	6.8	71 ... 160	31100	38900	70000	92100	28600	21000
	307R4	284	3.5	12000	5.0	71 ... 160	31500	39400	71000	93400	29600	21000
	307R4	300	3.3	14000	5.5	71 ... 160	31800	39700	71500	94100	30100	21000
	307R4	331	3.0	12300	4.4	71 ... 160	32200	40300	72500	95400	31100	21000
	307R4	363	2.8	12300	4.0	71 ... 160	32700	40800	73500	96700	32100	21000
307R4	413	2.4	12800	3.7	71 ... 160	33300	41600	74900	98500	33500	21000	
307R4	453	2.2	14000	3.6	71 ... 160	33700	42100	75900	99800	34600	21000	
307R4	490	2.0	9900	2.4	71 ... 160	34100	42600	76700	100900	35500	21000	
307R4	581	1.7	13300	2.7	71 ... 160	34900	43700	78600	103400	37600	21000	
307R4	690	1.4	10400	1.8	71 ... 160	35800	44800	80600	106000	39800	21000	
500	307R2	13.0	39	6780	29.1	132 ... 200	19100	23900	45000	59200	13300	18600
	307R2	15.5	32	7950	28.6	132 ... 200	20300	25400	47500	62400	14100	21000
	307R2	19.8	25.2	9630	27.0	132 ... 200	22000	27600	51100	67300	15300	21000
	307R2	23.5	21.2	8480	20.1	132 ... 200	23300	29200	53800	70800	16200	21000
	307R3	31.6	15.8	7380	13.4	71 ... 160	25800	32200	58800	77400	17900	18600
	307R3	37.7	13.2	9250	14.1	71 ... 160	27300	34100	62000	81600	19000	21000
	307R3	44.6	11.2	10900	14.1	71 ... 160	28900	36100	65200	85800	20100	21000
	307R3	55.9	8.9	13500	13.9	71 ... 160	30000	37500	67500	88800	21700	21000
	307R3	65.0	7.7	13700	12.1	71 ... 160	30000	37500	67500	88800	22800	21000
	307R3	71.8	7.0	11100	8.8	71 ... 160	30000	37500	67500	88800	23600	21000
	307R3	78.6	6.4	12300	9.0	71 ... 160	30000	37500	67500	88800	24300	21000
	307R3	83.4	6.0	11200	7.7	71 ... 160	30000	37500	67500	88800	24800	21000
	307R3	99.0	5.1	8700	5.0	71 ... 160	30000	37500	67500	88800	26200	21000
	307R3	120	4.2	8930	4.3	71 ... 160	30800	38500	69300	91100	27900	21000
	307R4	152	3.3	14900	5.8	71 ... 160	31800	39800	71700	94300	30300	21000
	307R4	165	3.0	12300	4.4	71 ... 160	32200	40300	72500	95400	31100	21000
	307R4	191	2.6	14900	4.6	71 ... 160	32900	41100	74000	97400	32600	21000
	307R4	206	2.4	14900	4.3	71 ... 160	33300	41600	74800	98400	33500	21000
	307R4	232	2.2	13000	3.3	71 ... 160	33800	42300	76100	100200	34800	21000
	307R4	258	1.9	15100	3.5	71 ... 160	34400	42900	77300	101700	36100	21000
307R4	284	1.8	13500	2.8	71 ... 160	34800	43500	78400	103100	37300	21000	
307R4	300	1.7	14400	2.8	71 ... 160	35100	43900	79000	103900	38000	21000	
307R4	331	1.5	13800	2.5	71 ... 160	35600	44500	80100	105400	39200	21000	
307R4	363	1.4	12300	2.0	71 ... 160	36100	45100	81100	106800	40400	21000	
307R4	413	1.2	14400	2.1	71 ... 160	36700	45900	82700	108800	42200	21000	
307R4	453	1.1	14900	1.9	71 ... 160	37200	46500	83800	110200	43500	21000	
307R4	490	1.0	11000	1.3	71 ... 160	37700	47100	84700	111400	44700	21000	
307R4	581	0.86	14300	1.5	71 ... 160	38600	48200	86800	114200	45000	21000	
307R4	690	0.72	11000	0.94	71 ... 160	39500	49400	88900	117000	45000	21000	



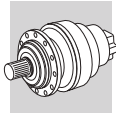

309 R



16460 Nm

n ₁ min ⁻¹	i	n ₂ min ⁻¹	M _{n2} Nm	P _{n1} kW	P (IEC)	Rn ₂ [N]					M _{2 max} Nm		
						MC	MZ	HC/PC	HZ/PZ	FZ			
1500	309R2	13.0	116	5110	66	132 ... 200	—	—	33100	42600	7390	27400	
	309R2	15.5	97	6090	66	132 ... 200	—	—	34900	44900	7830	27400	
	309R2	19.8	76	7820	66	132 ... 200	—	—	37600	48400	8510	27400	
	309R2	23.5	64	9280	66	132 ... 200	—	—	39600	50900	9010	27400	
	309R3	31.6	47	5580	30	71 ... 160	—	—	43300	55700	9950	27900	
	309R3	37.7	40	6650	30	71 ... 160	—	—	45600	58700	10500	29000	
	309R3	44.6	34	7860	30	71 ... 160	—	—	47900	61700	11100	29000	
	309R3	55.9	26.8	9860	30	71 ... 160	—	—	51300	66000	12000	29000	
	309R3	65.0	23.1	11200	29.6	71 ... 160	—	—	53700	69100	12600	29000	
	309R3	71.8	20.9	12700	30	71 ... 160	—	—	55300	71200	13100	29000	
	309R3	83.4	18.0	14000	28.8	71 ... 160	—	—	57900	74500	13700	29000	
	309R3	99.0	15.2	12800	22.2	71 ... 160	—	—	60900	78400	14500	29000	
	309R3	120	12.5	12900	18.6	71 ... 160	—	—	64500	83000	15500	29000	
	309R4	152	9.9	18600	15.0	71 ... 160	—	—	69000	88800	16800	29000	
	309R4	165	9.1	16300	15.0	71 ... 160	—	—	69000	88800	17300	29000	
	309R4	191	7.9	17300	15.0	71 ... 160	—	—	69000	88800	18100	29000	
	309R4	206	7.3	19800	15.0	71 ... 160	—	—	69000	88800	18600	29000	
	309R4	232	6.5	16700	12.7	71 ... 160	—	—	69000	88800	19300	29000	
	309R4	258	5.8	17400	12.0	71 ... 160	—	—	69000	88800	20000	29000	
	309R4	284	5.3	16900	10.5	71 ... 160	—	—	69000	88800	20700	29000	
	309R4	331	4.5	17200	9.2	71 ... 160	—	—	70000	90100	21800	29000	
	309R4	374	4.0	14300	6.8	71 ... 160	—	—	71200	91700	22700	29000	
	309R4	413	3.6	17900	7.7	71 ... 160	—	—	72200	93000	23400	29000	
	309R4	457	3.3	13800	5.4	71 ... 160	—	—	73300	94300	24200	29000	
	309R4	490	3.1	14000	5.1	71 ... 160	—	—	74000	95300	24800	29000	
	309R4	581	2.6	15800	4.8	71 ... 160	—	—	75800	97600	26200	29000	
	309R4	690	2.2	14800	3.8	71 ... 160	—	—	77700	100000	27800	29000	
	1000	309R2	13.0	77	5770	50	132 ... 200	—	—	37400	48100	8450	27400
		309R2	15.5	65	6880	50	132 ... 200	—	—	39400	50700	8970	27400
		309R2	19.8	50	8830	50	132 ... 200	—	—	42500	54700	9740	27400
		309R2	23.5	42	10200	48	132 ... 200	—	—	44700	57500	10300	27400
		309R3	31.6	32	6300	22.9	71 ... 160	—	—	48900	62900	11400	27900
309R3		37.7	26.5	7510	22.8	71 ... 160	—	—	51500	66300	12100	29000	
309R3		44.6	22.4	8870	22.9	71 ... 160	—	—	54100	69700	12800	29000	
309R3		55.9	17.9	11100	22.9	71 ... 160	—	—	58000	74600	13800	29000	
309R3		65.0	15.4	12500	22.0	71 ... 160	—	—	60600	78000	14500	29000	
309R3		71.8	13.9	14300	22.9	71 ... 160	—	—	62500	80400	15000	29000	
309R3		83.4	12.0	15500	21.3	71 ... 160	—	—	65300	84100	15700	29000	
309R3		99.0	10.1	13000	15.1	71 ... 160	—	—	68800	88500	16700	29000	
309R3		120	8.4	13000	12.5	71 ... 160	—	—	69000	88800	17700	29000	
309R4		152	6.6	20200	15.0	71 ... 160	—	—	69000	88800	19200	29000	
309R4		165	6.1	16700	12.0	71 ... 160	—	—	69000	88800	19800	29000	
309R4		191	5.2	17500	10.8	71 ... 160	—	—	69000	88800	20700	29000	
309R4		206	4.9	21300	12.2	71 ... 160	—	—	69300	89200	21200	29000	
309R4		232	4.3	17200	8.8	71 ... 160	—	—	70500	90700	22100	29000	
309R4		258	3.9	17500	8.0	71 ... 160	—	—	71600	92100	22900	29000	
309R4		284	3.5	17500	7.3	71 ... 160	—	—	72600	93400	23700	29000	
309R4		331	3.0	18500	6.6	71 ... 160	—	—	74200	95400	24900	29000	
309R4		374	2.7	14300	4.5	71 ... 160	—	—	75500	97100	25900	29000	
309R4		413	2.4	19200	5.5	71 ... 160	—	—	76500	98500	26800	29000	
309R4		457	2.2	14800	3.8	71 ... 160	—	—	77600	99900	27700	29000	
309R4		490	2.0	14900	3.6	71 ... 160	—	—	78400	100900	28400	29000	
309R4		581	1.7	15800	3.2	71 ... 160	—	—	80400	103400	30000	29000	
309R4		690	1.4	15900	2.7	71 ... 160	—	—	82300	106000	31800	29000	
500		309R2	13.0	39	6780	29.1	132 ... 200	—	—	46000	59200	10700	27400
		309R2	15.5	32	7950	28.6	132 ... 200	—	—	48500	62400	11300	27400
		309R2	19.8	25.2	10200	28.5	132 ... 200	—	—	52300	67300	12300	27400
		309R2	23.5	21.2	11200	26.4	132 ... 200	—	—	55000	70800	13000	27400
		309R3	31.6	15.8	7760	14.1	71 ... 160	—	—	60100	77400	14300	27900

B

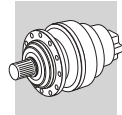

309 R



16460 Nm

n ₁ min ⁻¹		i	n ₂ min ⁻¹	M _{n2} Nm	P _{n1} kW	P (IEC)	Rn ₂ [N]					M _{2 max} Nm
							MC	MZ	HC/PC	HZ/PZ	FZ	
500	309R3	37.7	13.2	9250	14.1	71 ... 160	—	—	63400	81600	15200	29000
	309R3	44.6	11.2	10900	14.1	71 ... 160	—	—	66700	85800	16100	29000
	309R3	55.9	8.9	13700	14.1	71 ... 160	—	—	69000	88800	17300	29000
	309R3	65.0	7.7	14100	12.5	71 ... 160	—	—	69000	88800	18200	29000
	309R3	71.8	7.0	16400	13.1	71 ... 160	—	—	69000	88800	18800	29000
	309R3	83.4	6.0	16700	11.5	71 ... 160	—	—	69000	88800	19800	29000
	309R3	99.0	5.1	13000	7.5	71 ... 160	—	—	69000	88800	21000	29000
	309R3	120	4.2	13400	6.4	71 ... 160	—	—	70800	91100	22400	29000
	309R4	152	3.3	21300	8.3	71 ... 160	—	—	73200	94300	24200	29000
	309R4	165	3.0	18400	6.6	71 ... 160	—	—	74100	95400	24900	29000
	309R4	191	2.6	17500	5.4	71 ... 160	—	—	75700	97400	26100	29000
	309R4	206	2.4	21300	6.1	71 ... 160	—	—	76500	98400	26800	29000
	309R4	232	2.2	18100	4.6	71 ... 160	—	—	77800	100200	27900	29000
	309R4	258	1.9	17800	4.1	71 ... 160	—	—	79000	101700	28900	29000
	309R4	284	1.8	18200	3.8	71 ... 160	—	—	80100	103100	29800	29000
	309R4	331	1.5	20600	3.7	71 ... 160	—	—	81900	105400	31400	29000
	309R4	374	1.3	14600	2.3	71 ... 160	—	—	83300	107200	32700	29000
	309R4	413	1.2	21300	3.1	71 ... 160	—	—	84500	108800	33800	29000
	309R4	457	1.1	16700	2.2	71 ... 160	—	—	85700	110300	34900	29000
	309R4	490	1.0	16900	2.0	71 ... 160	—	—	86600	111400	35800	29000
309R4	581	0.86	15800	1.6	71 ... 160	—	—	88700	114200	36000	29000	
309R4	690	0.72	17000	1.5	71 ... 160	—	—	90900	117000	36000	29000	

310M R



33640 Nm

n ₁ min ⁻¹		i	n ₂ min ⁻¹	M _{n2} Nm	P _{n1} kW	P (IEC)	Rn ₂ [N]					M _{2 max} Nm
							MC	MZ	HC/PC	HZ/PZ	FZ	
1500	310MR2B	12.0	125	11900	130	160 ... 225	—	—	36600	46400	13000	47600
	310MR2B	15.4	97	15200	130	160 ... 225	—	—	39400	50000	14100	47600
	310MR2B	18.3	82	17000	130	160 ... 225	—	—	41500	52600	15000	47600
	310MR2C	16.6	90	15000	130	160 ... 250	—	—	40300	51100	14500	47600
	310MR2C	21.3	70	18700	130	160 ... 250	—	—	43500	55100	15800	47600
	310MR2C	25.3	59	17500	115	160 ... 250	—	—	45800	58000	16700	47600
	310MR3	37.7	40	6480	29.6	71 ... 160	—	—	51600	65400	19000	47600
	310MR3	44.6	34	7650	29.5	71 ... 160	—	—	54200	68700	20100	47600
	310MR3	55.9	26.8	9600	29.5	71 ... 160	—	—	58000	73600	21700	47600
	310MR3	65.0	23.1	11200	29.5	71 ... 160	—	—	60700	77000	22800	47600
	310MR3	71.8	20.9	12300	29.5	71 ... 160	—	—	62500	79300	23600	47600
	310MR3	78.6	19.1	13500	29.6	71 ... 160	—	—	64300	81500	24300	47600
	310MR3	83.4	18.0	14300	29.6	71 ... 160	—	—	65400	82900	24800	47600
	310MR3	99.0	15.2	16000	27.9	71 ... 160	—	—	68900	87300	26300	47600
	310MR3	120	12.5	17100	24.6	71 ... 160	—	—	72900	92400	28000	47600
	310MR4	136	11.0	22600	29.5	71 ... 160	—	—	75700	96000	29200	47600
	310MR4	160	9.4	26100	28.8	71 ... 160	—	—	78000	98900	30900	47600
	310MR4	189	7.9	27400	25.7	71 ... 160	—	—	78000	98900	32600	47600
	310MR4	206	7.3	22100	19.1	71 ... 160	—	—	78000	98900	33500	47600
	310MR4	238	6.3	28400	21.2	71 ... 160	—	—	78000	98900	35200	47600
310MR4	258	5.8	22500	15.4	71 ... 160	—	—	78000	98900	36200	47600	
310MR4	276	5.4	27900	17.9	71 ... 160	—	—	78000	98900	37000	47600	
310MR4	305	4.9	22800	13.2	71 ... 160	—	—	78200	99100	38200	47600	
310MR4	347	4.3	29600	15.2	71 ... 160	—	—	79600	101000	39900	47600	
310MR4	383	3.9	23700	11.0	71 ... 160	—	—	80800	102400	41200	47600	
310MR4	454	3.3	19400	7.6	71 ... 160	—	—	82800	104900	43600	47600	
310MR4	517	2.9	25000	8.6	71 ... 160	—	—	84300	106900	45600	47600	
310MR4	590	2.5	19300	5.8	71 ... 160	—	—	85900	108900	47600	47600	
310MR4	639	2.3	20600	5.7	71 ... 160	—	—	86900	110200	48900	47600	
310MR4	757	2.0	24800	5.8	71 ... 160	—	—	89000	112900	51700	47600	
310MR4	898	1.7	21900	4.3	71 ... 160	—	—	91200	115700	54800	47600	

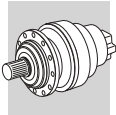

310M R



33640 Nm

n ₁ min ⁻¹	i	n ₂ min ⁻¹	M _{n2} Nm	P _{n1} kW	P (IEC)	Rn ₂ [N]					M ₂ max Nm		
						MC	MZ	HC/PC	HZ/PZ	FZ			
1000	310MR2B	12.0	83	13400	124	160 ... 225	—	—	41300	52400	14900	47600	
	310MR2B	15.4	65	17200	124	160 ... 225	—	—	44500	56400	16200	47600	
	310MR2B	18.3	55	17700	107	160 ... 225	—	—	46900	59400	17100	47600	
	310MR2C	16.6	60	16900	113	160 ... 250	—	—	45500	57700	16600	47600	
	310MR2C	21.3	47	20700	108	160 ... 250	—	—	49100	62200	18000	47600	
	310MR2C	25.3	39	17800	78	160 ... 250	—	—	51700	65500	19100	47600	
	310MR3	37.7	26.5	7320	22.2	71 ... 160	—	—	58200	73800	21800	47600	
	310MR3	44.6	22.4	8640	22.2	71 ... 160	—	—	61200	77600	23000	47600	
	310MR3	55.9	17.9	10800	22.2	71 ... 160	—	—	65500	83100	24900	47600	
	310MR3	65.0	15.4	12600	22.2	71 ... 160	—	—	68500	86900	26100	47600	
	310MR3	71.8	13.9	13900	22.2	71 ... 160	—	—	70600	89500	27000	47600	
	310MR3	78.6	12.7	15200	22.3	71 ... 160	—	—	72600	92000	27800	47600	
	310MR3	83.4	12.0	16200	22.2	71 ... 160	—	—	73900	93700	28400	47600	
	310MR3	99.0	10.1	17800	20.6	71 ... 160	—	—	77800	98600	30100	47600	
	310MR3	120	8.4	17900	17.1	71 ... 160	—	—	78000	98900	32000	47600	
	310MR4	136	7.4	25600	22.2	71 ... 160	—	—	78000	98900	33400	47600	
	310MR4	160	6.2	28200	20.8	71 ... 160	—	—	78000	98900	35300	47600	
	310MR4	189	5.3	29100	18.2	71 ... 160	—	—	78000	98900	37300	47600	
	310MR4	206	4.9	22800	13.1	71 ... 160	—	—	78300	99300	38400	47600	
	310MR4	238	4.2	30000	14.9	71 ... 160	—	—	79900	101400	40300	47600	
	310MR4	258	3.9	23700	10.9	71 ... 160	—	—	80900	102600	41400	47600	
	310MR4	276	3.6	28100	12.0	71 ... 160	—	—	81700	103600	42300	47600	
	310MR4	305	3.3	24400	9.5	71 ... 160	—	—	82800	105000	43800	47600	
	310MR4	347	2.9	30400	10.4	71 ... 160	—	—	84400	107000	45700	47600	
	310MR4	383	2.6	25400	7.9	71 ... 160	—	—	85600	108500	47200	47600	
	310MR4	454	2.2	20800	5.4	71 ... 160	—	—	87700	111200	50000	47600	
	310MR4	517	1.9	26800	6.1	71 ... 160	—	—	89300	113300	52200	47600	
	310MR4	590	1.7	19400	3.9	71 ... 160	—	—	91000	115400	54500	47600	
	310MR4	639	1.6	22100	4.1	71 ... 160	—	—	92100	116700	56000	47600	
	310MR4	757	1.3	24800	3.9	71 ... 160	—	—	94300	119600	59200	47600	
	310MR4	898	1.1	23500	3.1	71 ... 160	—	—	96700	122600	62700	47600	
	500	310MR2B	12.0	42	16400	76	160 ... 225	—	—	50900	64500	18800	47600
		310MR2B	15.4	32	19400	70	160 ... 225	—	—	54800	69500	20400	47600
		310MR2B	18.3	27.3	17800	54	160 ... 225	—	—	57700	73200	21600	47600
		310MR2C	16.6	30	20200	68	160 ... 250	—	—	56100	71100	20900	47600
		310MR2C	21.3	23.4	21200	55	160 ... 250	—	—	60400	76600	22700	47600
		310MR2C	25.3	19.7	17800	39	160 ... 250	—	—	63600	80700	24100	47600
		310MR3	37.7	13.2	9010	13.7	71 ... 160	—	—	71700	90900	27500	47600
		310MR3	44.6	11.2	10600	13.7	71 ... 160	—	—	75300	95500	29000	47600
		310MR3	55.9	8.9	13300	13.7	71 ... 160	—	—	78000	98900	31300	47600
		310MR3	65.0	7.7	15500	13.7	71 ... 160	—	—	78000	98900	32900	47600
		310MR3	71.8	7.0	17100	13.7	71 ... 160	—	—	78000	98900	34000	47600
		310MR3	78.6	6.4	18300	13.3	71 ... 160	—	—	78000	98900	35100	47600
		310MR3	83.4	6.0	19900	13.7	71 ... 160	—	—	78000	98900	35800	47600
		310MR3	99.0	5.1	18000	10.4	71 ... 160	—	—	78000	98900	37900	47600
310MR3		120	4.2	18600	8.9	71 ... 160	—	—	80000	101500	40400	47600	
310MR4		136	3.7	29600	12.9	71 ... 160	—	—	81500	103300	42100	47600	
310MR4		160	3.1	31100	11.5	71 ... 160	—	—	83400	105800	44500	47600	
310MR4		189	2.6	31700	9.9	71 ... 160	—	—	85400	108300	47000	47600	
310MR4		206	2.4	25800	7.4	71 ... 160	—	—	86500	109600	48400	47600	
310MR4		238	2.1	32200	8.0	71 ... 160	—	—	88300	111900	50700	47600	
310MR4		258	1.9	26800	6.1	71 ... 160	—	—	89300	113300	52200	47600	
310MR4		276	1.8	28100	6.0	71 ... 160	—	—	90200	114300	53300	47600	
310MR4		305	1.6	27600	5.4	71 ... 160	—	—	91500	116000	55100	47600	
310MR4		347	1.4	32100	5.5	71 ... 160	—	—	93200	118100	57500	47600	
310MR4		383	1.3	28700	4.4	71 ... 160	—	—	94500	119800	59500	47600	
310MR4		454	1.1	23500	3.1	71 ... 160	—	—	96800	122800	62900	47600	
310MR4		517	0.97	30100	3.4	71 ... 160	—	—	98600	125100	65000	47600	
310MR4		590	0.85	19500	2.0	71 ... 160	—	—	100500	127400	65000	47600	
310MR4		639	0.78	23900	2.2	71 ... 160	—	—	101700	128900	65000	47600	
310MR4		757	0.66	24800	1.9	71 ... 160	—	—	104100	132100	65000	47600	
310MR4		898	0.56	23900	1.6	71 ... 160	—	—	106700	135300	65000	47600	

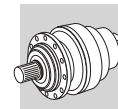

B



311M R



49210 Nm

n ₁ min ⁻¹		i	n ₂ min ⁻¹	M _{n2} Nm	P _{n1} kW	P (IEC) 	Rn ₂ [N]					M _{2 max} Nm	
							MC	MZ	HC/PC	HZ/PZ	FZ		
1500	311MR2B	12.0	125	11900	150	180 ... 250	—	—	46000	58600	13000	58300	
	311MR2B	15.4	97	15200	150	180 ... 250	—	—	49500	63200	14100	58300	
	311MR2B	18.3	82	18100	150	180 ... 250	—	—	52100	66500	15000	58300	
	311MR2C	16.6	90	15000	150	180 ... 250	—	—	50700	64600	14500	58300	
	311MR2C	21.3	70	19200	150	180 ... 250	—	—	54600	69600	15800	58300	
	311MR2C	25.3	59	22800	150	180 ... 250	—	—	57500	73300	16700	58300	
	311MR3	53.0	28.3	20300	66	132 ... 200	—	—	71700	91500	21300	58300	
	311MR3	63.2	23.7	24200	66	132 ... 200	—	—	75600	96500	22600	58300	
	311MR3	68.0	22.1	26000	66	132 ... 200	—	—	77300	98600	23200	58300	
	311MR3	81.1	18.5	29800	63	132 ... 200	—	—	81500	100000	24600	58300	
	311MR3	96.3	15.6	29600	53	132 ... 200	—	—	85800	100000	26000	58300	
	311MR3	104	14.4	33100	55	132 ... 200	—	—	87800	100000	26700	58300	
	311MR3	124	12.1	34200	48	132 ... 200	—	—	92500	100000	28300	58300	
	311MR3	147	10.2	27200	32	132 ... 200	—	—	97300	100000	29900	58300	
	311MR4	154	9.7	25700	29.5	71 ... 160	—	—	98000	100000	30500	58300	
	311MR4	182	8.2	30400	29.5	71 ... 160	—	—	98000	100000	32200	58300	
	311MR4	198	7.6	32800	29.3	71 ... 160	—	—	98000	100000	33100	58300	
	311MR4	229	6.6	38100	29.6	71 ... 160	—	—	98000	100000	34700	58300	
	311MR4	266	5.6	43900	29.3	71 ... 160	—	—	98000	100000	36500	58300	
	311MR4	294	5.1	36600	22.1	71 ... 160	—	—	98000	100000	37700	58300	
	311MR4	341	4.4	37500	19.5	71 ... 160	—	—	99800	101900	39700	58300	
	311MR4	413	3.6	38800	16.7	71 ... 160	—	—	102600	104700	42300	58300	
	311MR4	438	3.4	39200	15.9	71 ... 160	—	—	103400	105600	43100	58300	
	311MR4	490	3.1	32000	11.6	71 ... 160	—	—	105100	107300	44800	58300	
	311MR4	520	2.9	40200	13.7	71 ... 160	—	—	106000	108200	45700	58300	
	311MR4	629	2.4	41200	11.6	71 ... 160	—	—	108900	111100	48600	58300	
	311MR4	746	2.0	32300	7.7	71 ... 160	—	—	111600	113900	51500	58300	
	1000	311MR2B	12.0	83	13400	124	180 ... 250	—	—	51900	66200	14900	58300
		311MR2B	15.4	65	17200	124	180 ... 250	—	—	55900	71300	16200	58300
		311MR2B	18.3	55	20400	124	180 ... 250	—	—	58900	75100	17100	58300
		311MR2C	16.6	60	16900	113	180 ... 250	—	—	57200	73000	16600	58300
		311MR2C	21.3	47	21700	113	180 ... 250	—	—	61700	78700	18000	58300
		311MR2C	25.3	39	24400	107	180 ... 250	—	—	64900	82800	19100	58300
		311MR3	53.0	18.9	22900	50	132 ... 200	—	—	81000	100000	24400	58300
		311MR3	63.2	15.8	27300	50	132 ... 200	—	—	85400	100000	25900	58300
311MR3		68.0	14.7	29400	50	132 ... 200	—	—	87300	100000	26500	58300	
311MR3		81.1	12.3	33200	47	132 ... 200	—	—	92000	100000	28100	58300	
311MR3		96.3	10.4	31800	38	132 ... 200	—	—	96900	100000	29800	58300	
311MR3		104	9.6	35100	39	132 ... 200	—	—	98000	100000	30600	58300	
311MR3		124	8.1	35500	33	132 ... 200	—	—	98000	100000	32400	58300	
311MR3		147	6.8	27300	21.4	132 ... 200	—	—	98000	100000	34300	58300	
311MR4		154	6.5	29000	22.2	71 ... 160	—	—	98000	100000	34900	58300	
311MR4		182	5.5	34300	22.2	71 ... 160	—	—	98000	100000	36900	58300	
311MR4		198	5.0	36600	21.8	71 ... 160	—	—	98000	100000	37900	58300	
311MR4		229	4.4	42300	21.9	71 ... 160	—	—	99900	101900	39800	58300	
311MR4		266	3.8	45900	20.4	71 ... 160	—	—	102100	104200	41800	58300	
311MR4		294	3.4	39200	15.8	71 ... 160	—	—	103500	105600	43200	58300	
311MR4		341	2.9	40300	14.0	71 ... 160	—	—	105800	107900	45400	58300	
311MR4		413	2.4	41600	11.9	71 ... 160	—	—	108700	110900	48400	58300	
311MR4		438	2.3	42000	11.3	71 ... 160	—	—	109600	111800	49400	58300	
311MR4		490	2.0	32300	7.8	71 ... 160	—	—	111400	113700	51200	58300	
311MR4		520	1.9	41200	9.4	71 ... 160	—	—	112300	114600	52300	58300	
311MR4		629	1.6	41200	7.8	71 ... 160	—	—	115400	117800	55700	58300	
311MR4		746	1.3	34600	5.5	71 ... 160	—	—	118300	120700	59000	58300	
500		311MR2B	12.0	42	16400	76	180 ... 250	—	—	63900	81500	18800	58300
		311MR2B	15.4	32	21200	76	180 ... 250	—	—	68900	87800	20400	58300
		311MR2B	18.3	27.3	23100	70	180 ... 250	—	—	72500	92500	21600	58300
		311MR2C	16.6	30	20800	70	180 ... 250	—	—	70400	89900	20900	58300
		311MR2C	21.3	23.4	26700	70	180 ... 250	—	—	75900	96800	22700	58300
		311MR2C	25.3	19.7	25800	57	180 ... 250	—	—	79900	100000	24100	58300

B

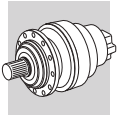

311M R

358

49210 Nm

n ₁ min ⁻¹		i	n ₂ min ⁻¹	M _{n2} Nm	P _{n1} kW	P (IEC)	Rn ₂ [N]					M ₂ max Nm
							MC	MZ	HC/PC	HZ/PZ	FZ	
500	311MR3	53.0	9.4	28100	30	132 ... 200	—	—	98000	100000	30800	58300
	311MR3	63.2	7.9	33600	31	132 ... 200	—	—	98000	100000	32600	58300
	311MR3	68.0	7.4	34600	29.2	132 ... 200	—	—	98000	100000	33400	58300
	311MR3	81.1	6.2	36200	25.6	132 ... 200	—	—	98000	100000	35500	58300
	311MR3	96.3	5.2	32000	19.1	132 ... 200	—	—	98000	100000	37500	58300
	311MR3	104	4.8	36900	20.4	132 ... 200	—	—	98600	100600	38500	58300
	311MR3	124	4.0	38000	17.6	132 ... 200	—	—	101000	103100	40800	58300
	311MR3	147	3.4	29400	11.5	132 ... 200	—	—	103500	105600	43200	58300
	311MR4	154	3.2	35800	13.7	71 ... 160	—	—	104300	106400	43900	58300
	311MR4	182	2.7	42200	13.7	71 ... 160	—	—	106800	109000	46400	58300
	311MR4	198	2.5	41300	12.3	71 ... 160	—	—	108100	110300	47700	58300
	311MR4	229	2.2	47000	12.1	71 ... 160	—	—	110300	112500	50100	58300
	311MR4	266	1.9	47400	10.5	71 ... 160	—	—	112700	115000	52700	58300
	311MR4	294	1.7	44000	8.9	71 ... 160	—	—	114300	116600	54400	58300
	311MR4	341	1.5	45000	7.8	71 ... 160	—	—	116800	119200	57200	58300
	311MR4	413	1.2	46400	6.6	71 ... 160	—	—	120000	122400	61000	58300
	311MR4	438	1.1	46800	6.3	71 ... 160	—	—	121000	123500	62200	58300
	311MR4	490	1.0	33500	4.0	71 ... 160	—	—	123000	125500	64600	58300
	311MR4	520	0.96	41300	4.7	71 ... 160	—	—	124000	126500	65000	58300
	311MR4	629	0.80	41300	3.9	71 ... 160	—	—	127400	130000	65000	58300
311MR4	746	0.67	36500	2.9	71 ... 160	—	—	130600	133300	65000	58300	

313M R

370

60940 Nm

n ₁ min ⁻¹		i	n ₂ min ⁻¹	M _{n2} Nm	P _{n1} kW	P (IEC)	Rn ₂ [N]					M ₂ max Nm
							MC	MZ	HC/PC	HZ/PZ	FZ	
1500	313MR2B	12.2	123	12000	150	180 ... 250	—	—	66800	78300	16100	86300
	313MR2B	15.9	95	15700	150	180 ... 250	—	—	72400	84800	17600	86300
	313MR2B	19.1	79	18800	150	180 ... 250	—	—	76500	89700	18700	86300
	313MR2C	16.8	89	15200	150	180 ... 250	—	—	73700	86400	17900	105000
	313MR2C	22.0	68	19800	150	180 ... 250	—	—	79800	93500	19600	105000
	313MR2C	26.4	57	23800	150	180 ... 250	—	—	84400	98800	20800	105000
	313MR3	53.7	28.0	20500	66	132 ... 200	—	—	104300	122200	26400	105000
	313MR3	64.0	23.4	24500	66	132 ... 200	—	—	110000	128900	28000	105000
	313MR3	69.9	21.4	26700	66	132 ... 200	—	—	112900	132400	28800	105000
	313MR3	82.2	18.3	31400	66	132 ... 200	—	—	118500	138900	30400	105000
	313MR3	97.5	15.4	37300	66	132 ... 200	—	—	124800	146200	32200	105000
	313MR3	107	14.0	38200	61	132 ... 200	—	—	128400	150400	33200	105000
	313MR3	127	11.8	40300	55	132 ... 200	—	—	135100	158300	35100	105000
	313MR3	153	9.8	30200	34	132 ... 200	—	—	142000	166400	37400	105000
	313MR4	185	8.1	30700	29.6	71 ... 160	—	—	142000	166400	39800	105000
	313MR4	201	7.5	33400	29.6	71 ... 160	—	—	142000	166400	40900	105000
	313MR4	237	6.3	39500	29.6	71 ... 160	—	—	142000	166400	43200	105000
	313MR4	281	5.3	46800	29.6	71 ... 160	—	—	142000	166400	45800	105000
	313MR4	309	4.9	43400	24.9	71 ... 160	—	—	142600	167100	47200	105000
	313MR4	346	4.3	55700	28.6	71 ... 160	—	—	144900	169800	49000	105000
313MR4	387	3.9	45100	20.7	71 ... 160	—	—	147300	172600	50900	105000	
313MR4	450	3.3	46300	18.2	71 ... 160	—	—	150500	176300	53600	105000	
313MR4	496	3.0	48600	17.4	71 ... 160	—	—	152600	178800	55300	105000	
313MR4	535	2.8	47700	15.8	71 ... 160	—	—	154200	180700	56700	105000	
313MR4	647	2.3	49300	13.5	71 ... 160	—	—	158500	185700	60400	105000	
313MR4	778	1.9	35800	8.1	71 ... 160	—	—	162700	190700	64300	105000	
1000	313MR2B	12.2	82	13600	124	180 ... 250	—	—	75500	88500	18400	86300
	313MR2B	15.9	63	17700	124	180 ... 250	—	—	81700	95800	20100	86300
	313MR2B	19.1	52	21300	124	180 ... 250	—	—	86400	101300	21400	86300
	313MR2C	16.8	59	17100	113	180 ... 250	—	—	83200	97500	20500	105000
	313MR2C	22.0	46	22300	113	180 ... 250	—	—	90100	105600	22400	105000
	313MR2C	26.4	38	25600	108	180 ... 250	—	—	95300	111600	23800	105000

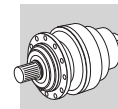

313M R



60940 Nm

n ₁ min ⁻¹		i	n ₂ min ⁻¹	M _{n2} Nm	P _{n1} kW	P (IEC)	Rn ₂ [N]					M _{2 max} Nm
							MC	MZ	HC/PC	HZ/PZ	FZ	
1000	313MR3	53.7	18.6	23200	50	132 ... 200	—	—	117800	138100	30200	105000
	313MR3	64.0	15.6	27700	50	132 ... 200	—	—	124200	145600	32000	105000
	313MR3	69.9	14.3	30200	50	132 ... 200	—	—	127600	149500	33000	105000
	313MR3	82.2	12.2	35500	50	132 ... 200	—	—	133900	156900	34800	105000
	313MR3	97.5	10.3	42100	50	132 ... 200	—	—	140900	165100	36800	105000
	313MR3	107	9.3	41600	45	132 ... 200	—	—	142000	166400	38000	105000
	313MR3	127	7.9	42000	38	132 ... 200	—	—	142000	166400	40200	105000
	313MR3	153	6.5	30200	22.7	132 ... 200	—	—	142000	166400	42800	105000
	313MR4	185	5.4	34700	22.2	71 ... 160	—	—	142000	166400	45500	105000
	313MR4	201	5.0	37700	22.2	71 ... 160	—	—	142100	166500	46800	105000
	313MR4	237	4.2	44600	22.2	71 ... 160	—	—	145500	170500	49500	105000
	313MR4	281	3.6	48200	20.3	71 ... 160	—	—	149100	174700	52400	105000
	313MR4	309	3.2	46500	17.8	71 ... 160	—	—	151100	177000	54100	105000
	313MR4	346	2.9	57100	19.6	71 ... 160	—	—	153500	179900	56100	105000
	313MR4	387	2.6	48400	14.8	71 ... 160	—	—	156100	182900	58300	105000
	313MR4	450	2.2	49700	13.1	71 ... 160	—	—	159500	186900	61300	105000
	313MR4	496	2.0	49100	11.7	71 ... 160	—	—	161700	189500	63300	105000
	313MR4	535	1.9	51200	11.3	71 ... 160	—	—	163400	191500	64900	105000
	313MR4	647	1.5	53000	9.7	71 ... 160	—	—	167900	196800	69200	105000
	313MR4	778	1.3	38400	5.8	71 ... 160	—	—	172400	202100	73600	105000
500	313MR2B	12.2	41	16600	76	180 ... 250	—	—	92900	108900	23200	86300
	313MR2B	15.9	32	21800	76	180 ... 250	—	—	100600	117900	25300	86300
	313MR2B	19.1	26.2	24700	72	180 ... 250	—	—	106400	124700	26900	86300
	313MR2C	16.8	29.7	21100	70	180 ... 250	—	—	102500	120100	25800	105000
	313MR2C	22.0	22.8	27500	70	180 ... 250	—	—	110900	130000	28200	105000
	313MR2C	26.4	18.9	27900	59	180 ... 250	—	—	117300	137400	30000	105000
	313MR3	53.7	9.3	28500	30	132 ... 200	—	—	142000	166400	38000	105000
	313MR3	64.0	7.8	34100	31	132 ... 200	—	—	142000	166400	40300	105000
	313MR3	69.9	7.1	37200	31	132 ... 200	—	—	142000	166400	41500	105000
	313MR3	82.2	6.1	43700	31	132 ... 200	—	—	142000	166400	43800	105000
	313MR3	97.5	5.1	48400	28.5	132 ... 200	—	—	142000	166400	46400	105000
	313MR3	107	4.7	43700	23.4	132 ... 200	—	—	143400	168000	47900	105000
	313MR3	127	3.9	45000	20.3	132 ... 200	—	—	147000	172200	50700	105000
	313MR3	153	3.3	32600	12.2	132 ... 200	—	—	150900	176800	53900	105000
	313MR4	185	2.7	42700	13.7	71 ... 160	—	—	155000	181600	57400	105000
	313MR4	201	2.5	46500	13.7	71 ... 160	—	—	156900	183800	59000	105000
	313MR4	237	2.1	53700	13.4	71 ... 160	—	—	160600	188200	62400	105000
	313MR4	281	1.8	49400	10.4	71 ... 160	—	—	164600	192900	66000	105000
	313MR4	309	1.6	52500	10.1	71 ... 160	—	—	166800	195500	68100	105000
	313MR4	346	1.4	59600	10.2	71 ... 160	—	—	169500	198600	70700	105000
313MR4	387	1.3	54600	8.3	71 ... 160	—	—	172300	201900	73500	105000	
313MR4	450	1.1	56100	7.4	71 ... 160	—	—	176100	206300	77300	105000	
313MR4	496	1.0	50800	6.1	71 ... 160	—	—	178500	209200	79800	105000	
313MR4	535	0.94	57100	6.3	71 ... 160	—	—	180400	211400	80000	105000	
313MR4	647	0.77	57100	5.2	71 ... 160	—	—	185400	217300	80000	105000	
313MR4	778	0.64	40100	3.0	71 ... 160	—	—	190400	223100	80000	105000	

314M R



80640 Nm

n ₁ min ⁻¹		i	n ₂ min ⁻¹	M _{n2} Nm	P _{n1} kW	P (IEC)	Rn ₂ [N]					M _{2 max} Nm
							MC	MZ	HC/PC	HZ/PZ	FZ	
1500	314MR3B	51.1	29.4	39100	130	180 ... 250	—	—	95500	114600	29200	115000
	314MR3B	65.5	22.9	50200	130	180 ... 250	—	—	103000	123500	31700	115000
	314MR3B	77.8	19.3	52500	116	180 ... 250	—	—	108400	130000	33600	115000
	314MR3B	82.3	18.2	54400	114	180 ... 250	—	—	110200	132200	34200	115000
	314MR3B	97.6	15.4	57300	101	180 ... 250	—	—	116000	139200	36200	115000
	314MR3B	113	13.2	47400	72	180 ... 250	—	—	121400	145600	38100	115000
	314MR3C	70.7	21.2	49400	120	180 ... 250	—	—	105300	126300	32500	115000

B

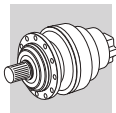

314M R



80640 Nm

n ₁ min ⁻¹	i	n ₂ min ⁻¹	M _{n2} Nm	P _{n1} kW	P (IEC)	Rn ₂ [N]					M _{2 max} Nm		
						MC	MZ	HC/PC	HZ/PZ	FZ			
1500	314MR3C	90.7	16.5	61300	116	180 ... 250	—	—	113500	136100	35300	115000	
	314MR3C	108	13.9	55800	89	180 ... 250	—	—	119500	143300	37400	115000	
	314MR3C	114	13.2	58300	88	180 ... 250	—	—	121500	145700	38100	115000	
	314MR3C	135	11.1	59100	75	180 ... 250	—	—	127900	153400	40300	115000	
	314MR3C	157	9.5	47400	52	180 ... 250	—	—	132000	158300	42400	115000	
	314MR4	160	9.4	26700	29.5	71 ... 160	—	—	132000	158300	42700	115000	
	314MR4	189	7.9	31500	29.5	71 ... 160	—	—	132000	158300	45100	115000	
	314MR4	238	6.3	39600	29.5	71 ... 160	—	—	132000	158300	48700	115000	
	314MR4	276	5.4	46000	29.6	71 ... 160	—	—	132000	158300	51200	115000	
	314MR4	354	4.2	59000	29.5	71 ... 160	—	—	135200	162100	55600	115000	
	314MR4	421	3.6	68500	28.9	71 ... 160	—	—	138500	166100	58900	115000	
	314MR4	445	3.4	59300	23.6	71 ... 160	—	—	139600	167500	60000	115000	
	314MR4	528	2.8	65900	22.2	71 ... 160	—	—	143100	171600	63500	115000	
	314MR4	614	2.4	54200	15.7	71 ... 160	—	—	146200	175300	66800	115000	
	1000	314MR3B	51.1	19.6	44200	99	180 ... 250	—	—	107900	129400	33400	115000
		314MR3B	65.5	15.3	56700	99	180 ... 250	—	—	116300	139500	36300	115000
		314MR3B	77.8	12.9	56700	84	180 ... 250	—	—	122400	146800	38400	115000
		314MR3B	82.3	12.2	57900	81	180 ... 250	—	—	124500	149300	39100	115000
314MR3B		97.6	10.2	59600	70	180 ... 250	—	—	131000	157200	41400	115000	
314MR3B		113	8.8	47500	48	180 ... 250	—	—	132000	158300	43600	115000	
314MR3C		70.7	14.1	55800	90	180 ... 250	—	—	119000	142700	37200	115000	
314MR3C		90.7	11.0	69100	87	180 ... 250	—	—	128200	153800	40400	115000	
314MR3C		108	9.3	59500	63	180 ... 250	—	—	132000	158300	42800	115000	
314MR3C		114	8.8	60200	61	180 ... 250	—	—	132000	158300	43600	115000	
314MR3C		135	7.4	60800	52	180 ... 250	—	—	132000	158300	46200	115000	
314MR3C		157	6.4	47800	35	180 ... 250	—	—	132000	158300	48600	115000	
314MR4		160	6.2	30200	22.2	71 ... 160	—	—	132000	158300	48900	115000	
314MR4		189	5.3	35600	22.2	71 ... 160	—	—	132000	158300	51700	115000	
314MR4		238	4.2	44700	22.2	71 ... 160	—	—	135300	162200	55700	115000	
314MR4		276	3.6	52000	22.2	71 ... 160	—	—	138200	165800	58600	115000	
314MR4		354	2.8	66700	22.2	71 ... 160	—	—	143200	171800	63700	115000	
314MR4		421	2.4	74500	21.0	71 ... 160	—	—	146800	176000	67400	115000	
314MR4		445	2.2	65800	17.5	71 ... 160	—	—	148000	177500	68700	115000	
314MR4		528	1.9	69200	15.5	71 ... 160	—	—	151600	181800	72700	115000	
314MR4		614	1.6	58200	11.2	71 ... 160	—	—	154900	185800	76500	115000	
500	314MR3B	51.1	9.8	54400	61	180 ... 250	—	—	132000	158300	42100	115000	
	314MR3B	65.5	7.6	67400	59	180 ... 250	—	—	132000	158300	45700	115000	
	314MR3B	77.8	6.4	59500	44	180 ... 250	—	—	132000	158300	48400	115000	
	314MR3B	82.3	6.1	61600	43	180 ... 250	—	—	132000	158300	49300	115000	
	314MR3B	97.6	5.1	62200	37	180 ... 250	—	—	132000	158300	52200	115000	
	314MR3B	113	4.4	49000	24.8	180 ... 250	—	—	134400	161200	54900	115000	
	314MR3C	70.7	7.1	68400	56	180 ... 250	—	—	132000	158300	46900	115000	
	314MR3C	90.7	5.5	72200	46	180 ... 250	—	—	132000	158300	51000	115000	
	314MR3C	108	4.6	59500	32	180 ... 250	—	—	133400	160000	53900	115000	
	314MR3C	114	4.4	63200	32	180 ... 250	—	—	134500	161300	55000	115000	
	314MR3C	135	3.7	64500	27.4	180 ... 250	—	—	137800	165300	58200	115000	
	314MR3C	157	3.2	51800	18.9	180 ... 250	—	—	140800	168900	61200	115000	
	314MR4	160	3.1	37100	13.7	71 ... 160	—	—	141200	169400	61600	115000	
	314MR4	189	2.6	43800	13.7	71 ... 160	—	—	144600	173400	65100	115000	
	314MR4	238	2.1	55000	13.7	71 ... 160	—	—	149400	179100	70200	115000	
	314MR4	276	1.8	64000	13.7	71 ... 160	—	—	152600	183000	73800	115000	
	314MR4	354	1.4	82100	13.7	71 ... 160	—	—	158200	189700	80300	115000	
	314MR4	421	1.2	76700	10.8	71 ... 160	—	—	162100	194400	85000	115000	
	314MR4	445	1.1	72200	9.6	71 ... 160	—	—	163400	195900	86600	115000	
	314MR4	528	0.95	73300	8.2	71 ... 160	—	—	167400	200800	90000	115000	
	314MR4	614	0.81	63300	6.1	71 ... 160	—	—	171100	205100	90000	115000	

B

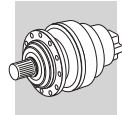

315M R



100800 Nm

n ₁ min ⁻¹	i	n ₂ min ⁻¹	M _{n2} Nm	P _{n1} kW	P (IEC)	Rn ₂ [N]					M _{2 max} Nm	
						MC	MZ	HC/PC	HZ/PZ	FZ		
1500	315MR3B	51.1	29.4	48900	150	180 ... 250	—	—	95500	114600	29200	135000
	315MR3B	65.5	22.9	62700	150	180 ... 250	—	—	103000	123500	31700	135000
	315MR3B	77.8	19.3	73600	150	180 ... 250	—	—	108400	130000	33600	135000
	315MR3B	82.3	18.2	68000	142	180 ... 250	—	—	110200	132200	34200	135000
	315MR3B	97.6	15.4	72000	127	180 ... 250	—	—	116000	139200	36200	135000
	315MR3B	113	13.2	59200	90	180 ... 250	—	—	121400	145600	38100	135000
	315MR3C	70.7	21.2	61700	150	180 ... 250	—	—	105300	126300	32500	135000
	315MR3C	90.7	16.5	77300	147	180 ... 250	—	—	113500	136100	35300	135000
	315MR3C	108	13.9	83100	133	180 ... 250	—	—	119500	143300	37400	135000
	315MR3C	114	13.2	72900	110	180 ... 250	—	—	121500	145700	38100	135000
	315MR3C	135	11.1	74000	94	180 ... 250	—	—	127900	153400	40300	135000
	315MR3C	157	9.5	59300	65	180 ... 250	—	—	132000	158300	42400	135000
	315MR4	225	6.7	83600	66	132 ... 200	—	—	132000	158300	47800	135000
	315MR4	269	5.6	92800	61	132 ... 200	—	—	132000	158300	50700	135000
	315MR4	345	4.3	94600	49	132 ... 200	—	—	134700	161500	55100	135000
	315MR4	409	3.7	94600	41	132 ... 200	—	—	138000	165500	58400	135000
	315MR4	525	2.9	94600	32	132 ... 200	—	—	143000	171500	63400	135000
	315MR4	623	2.4	94900	27.0	132 ... 200	—	—	146500	175700	67200	135000
	315MR4	659	2.3	85100	22.9	132 ... 200	—	—	147700	177100	68400	135000
	315MR4	782	1.9	86400	19.6	132 ... 200	—	—	151400	181500	72400	135000
315MR4	909	1.6	72500	14.2	132 ... 200	—	—	154700	185500	76200	135000	
1000	315MR3B	51.1	19.6	55200	124	180 ... 250	—	—	107900	129400	33400	135000
	315MR3B	65.5	15.3	70900	124	180 ... 250	—	—	116300	139500	36300	135000
	315MR3B	77.8	12.9	82700	122	180 ... 250	—	—	122400	146800	38400	135000
	315MR3B	82.3	12.2	72400	101	180 ... 250	—	—	124500	149300	39100	135000
	315MR3B	97.6	10.2	74500	88	180 ... 250	—	—	131000	157200	41400	135000
	315MR3B	113	8.8	59400	60	180 ... 250	—	—	132000	158300	43600	135000
	315MR3C	70.7	14.1	69700	113	180 ... 250	—	—	119000	142700	37200	135000
	315MR3C	90.7	11.0	86500	109	180 ... 250	—	—	128200	153800	40400	135000
	315MR3C	108	9.3	89500	95	180 ... 250	—	—	132000	158300	42800	135000
	315MR3C	114	8.8	75200	76	180 ... 250	—	—	132000	158300	43600	135000
	315MR3C	135	7.4	76000	65	180 ... 250	—	—	132000	158300	46200	135000
	315MR3C	157	6.4	59700	44	180 ... 250	—	—	132000	158300	48600	135000
	315MR4	225	4.4	91700	48	132 ... 200	—	—	134300	161000	54800	135000
	315MR4	269	3.7	94600	42	132 ... 200	—	—	137700	165100	58100	135000
	315MR4	345	2.9	94600	32	132 ... 200	—	—	142700	171100	63100	135000
	315MR4	409	2.4	94800	27.4	132 ... 200	—	—	146200	175300	66800	135000
	315MR4	525	1.9	96400	21.7	132 ... 200	—	—	151500	181700	72600	135000
	315MR4	623	1.6	97600	18.5	132 ... 200	—	—	155300	186200	76900	135000
	315MR4	659	1.5	88300	15.8	132 ... 200	—	—	156500	187700	78300	135000
	315MR4	782	1.3	89600	13.6	132 ... 200	—	—	160400	192400	82900	135000
315MR4	909	1.1	77800	10.1	132 ... 200	—	—	163900	196500	87200	135000	
500	315MR3B	51.1	9.8	68000	76	180 ... 250	—	—	132000	158300	42100	135000
	315MR3B	65.5	7.6	85700	75	180 ... 250	—	—	132000	158300	45700	135000
	315MR3B	77.8	6.4	92500	68	180 ... 250	—	—	132000	158300	48400	135000
	315MR3B	82.3	6.1	77000	54	180 ... 250	—	—	132000	158300	49300	135000
	315MR3B	97.6	5.1	77800	46	180 ... 250	—	—	132000	158300	52200	135000
	315MR3B	113	4.4	61200	31	180 ... 250	—	—	134400	161200	54900	135000
	315MR3C	70.7	7.1	85600	69	180 ... 250	—	—	132000	158300	46900	135000
	315MR3C	90.7	5.5	93800	59	180 ... 250	—	—	132000	158300	51000	135000
	315MR3C	108	4.6	94600	50	180 ... 250	—	—	133400	160000	53900	135000
	315MR3C	114	4.4	79100	40	180 ... 250	—	—	134500	161300	55000	135000
	315MR3C	135	3.7	80600	34	180 ... 250	—	—	137800	165300	58200	135000
	315MR3C	157	3.2	64800	23.7	180 ... 250	—	—	140800	168900	61200	135000
	315MR4	225	2.2	95400	25.1	132 ... 200	—	—	148200	177800	69000	135000
	315MR4	269	1.9	96600	21.3	132 ... 200	—	—	152000	182300	73200	135000
	315MR4	345	1.4	98200	16.8	132 ... 200	—	—	157500	188900	79500	135000
	315MR4	409	1.2	99400	14.4	132 ... 200	—	—	161400	193600	84200	135000

B

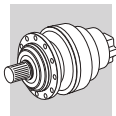

315M R



100800 Nm

n ₁ min ⁻¹		i	n ₂ min ⁻¹	M _{n2} Nm	P _{n1} kW	P (IEC)	Rn ₂ [N]					M _{2 max} Nm
							MC	MZ	HC/PC	HZ/PZ	FZ	
315MR4		525	0.95	100800	11.4	132 ... 200	—	—	167300	200600	90000	135000
315MR4		623	0.80	100800	9.6	132 ... 200	—	—	171400	205600	90000	135000
315MR4		659	0.76	91600	8.2	132 ... 200	—	—	172800	207200	90000	135000
315MR4		782	0.64	91600	6.9	132 ... 200	—	—	177100	212400	90000	135000
315MR4		909	0.55	79100	5.1	132 ... 200	—	—	180900	217000	90000	135000

316M R



134390 Nm

n ₁ min ⁻¹		i	n ₂ min ⁻¹	M _{n2} Nm	P _{n1} kW	P (IEC)	Rn ₂ [N]					M _{2 max} Nm
							MC	MZ	HC/PC	HZ/PZ	FZ	
1500	316MR3B	51.1	29.4	48900	150	180 ... 250	—	—	146200	164000	48600	192000
	316MR3B	64.1	23.4	61400	150	180 ... 250	—	—	156500	175600	52400	192000
	316MR3B	65.5	22.9	62700	150	180 ... 250	—	—	157600	176800	52800	192000
	316MR3B	77.8	19.3	74500	150	180 ... 250	—	—	165900	186100	55900	192000
	316MR3B	82.3	18.2	78700	150	180 ... 250	—	—	168700	189200	57000	192000
	316MR3B	97.6	15.4	89000	150	180 ... 250	—	—	177600	199200	60300	192000
	316MR3C	70.7	21.2	61700	150	180 ... 250	—	—	161200	180800	54200	192000
	316MR3C	88.7	16.9	77500	150	180 ... 250	—	—	172600	193600	58400	192000
	316MR3C	90.7	16.5	79200	150	180 ... 250	—	—	173700	194900	58900	192000
	316MR3C	108	13.9	94000	150	180 ... 250	—	—	182900	205200	62300	192000
	316MR3C	114	13.2	92900	140	180 ... 250	—	—	186000	208600	63500	192000
	316MR3C	135	11.1	97700	124	180 ... 250	—	—	195800	219600	67200	192000
	316MR4	225	6.7	83600	66	132 ... 200	—	—	202000	226600	79700	192000
	316MR4	269	5.6	99700	66	132 ... 200	—	—	202000	226600	84600	192000
	316MR4	289	5.2	107200	66	132 ... 200	—	—	202000	226600	86600	192000
	316MR4	337	4.4	101400	53	132 ... 200	—	—	205400	230400	91200	192000
	316MR4	363	4.1	102600	50	132 ... 200	—	—	207500	232800	93400	192000
	316MR4	430	3.5	105500	43	132 ... 200	—	—	212700	238600	98900	192000
	316MR4	443	3.4	125100	50	132 ... 200	—	—	213500	239500	99900	192000
	316MR4	525	2.9	125700	42	132 ... 200	—	—	218800	245500	105700	192000
316MR4	623	2.4	113800	32	132 ... 200	—	—	224200	251600	111900	192000	
316MR4	659	2.3	112400	30	132 ... 200	—	—	226000	253600	114000	192000	
316MR4	782	1.9	114300	25.9	132 ... 200	—	—	231600	259800	120700	192000	
1000	316MR3B	51.1	19.6	55200	124	180 ... 250	—	—	165100	185200	55700	192000
	316MR3B	64.1	15.6	69300	124	180 ... 250	—	—	176800	198300	60000	192000
	316MR3B	65.5	15.3	70900	124	180 ... 250	—	—	178000	199600	60500	192000
	316MR3B	77.8	12.9	84100	124	180 ... 250	—	—	187300	210200	64000	192000
	316MR3B	82.3	12.2	88900	124	180 ... 250	—	—	190500	213700	65200	192000
	316MR3B	97.6	10.2	98900	116	180 ... 250	—	—	200500	225000	69100	192000
	316MR3C	70.7	14.1	69700	113	180 ... 250	—	—	182000	204200	62000	192000
	316MR3C	88.7	11.3	87500	113	180 ... 250	—	—	194900	218600	66900	192000
	316MR3C	90.7	11.0	89500	113	180 ... 250	—	—	196200	220100	67400	192000
	316MR3C	108	9.3	104900	112	180 ... 250	—	—	202000	226600	71400	192000
	316MR3C	114	8.8	99500	100	180 ... 250	—	—	202000	226600	72700	192000
	316MR3C	135	7.4	99500	84	180 ... 250	—	—	202000	226600	77000	192000
	316MR4	225	4.4	94400	50	132 ... 200	—	—	205500	230500	91300	192000
	316MR4	269	3.7	112300	49	132 ... 200	—	—	210700	236400	96800	192000
	316MR4	289	3.5	117500	48	132 ... 200	—	—	212900	238800	99200	192000
	316MR4	337	3.0	108300	38	132 ... 200	—	—	217600	244200	104400	192000
	316MR4	363	2.8	109600	36	132 ... 200	—	—	219900	246700	107000	192000
	316MR4	430	2.3	112100	31	132 ... 200	—	—	225400	252800	113300	192000
	316MR4	443	2.3	127000	34	132 ... 200	—	—	226300	253800	114300	192000
	316MR4	525	1.9	128600	29.0	132 ... 200	—	—	231900	260100	121000	192000
316MR4	623	1.6	115800	22.0	132 ... 200	—	—	237600	266600	128100	192000	
316MR4	659	1.5	117100	21.0	132 ... 200	—	—	239500	268700	130500	192000	
316MR4	782	1.3	119200	18.0	132 ... 200	—	—	245500	275300	138200	192000	
316MR3B	51.1	9.8	68000	76	180 ... 250	—	—	202000	226600	70100	192000	
316MR3B	64.1	7.8	85300	76	180 ... 250	—	—	202000	226600	75600	192000	

B

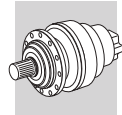

316M R



134390 Nm

n ₁ min ⁻¹		i	n ₂ min ⁻¹	M _{n2} Nm	P _{n1} kW	P (IEC)	Rn ₂ [N]					M _{2 max} Nm
							MC	MZ	HC/PC	HZ/PZ	FZ	
500	316MR3B	65.5	7.6	87200	76	180 ... 250	—	—	202000	226600	76200	192000
	316MR3B	77.8	6.4	103500	76	180 ... 250	—	—	202000	226600	80700	192000
	316MR3B	82.3	6.1	98000	68	180 ... 250	—	—	202000	226600	82200	192000
	316MR3B	97.6	5.1	99500	58	180 ... 250	—	—	202000	226600	87000	192000
	316MR3C	70.7	7.1	85800	70	180 ... 250	—	—	202000	226600	78100	192000
	316MR3C	88.7	5.6	97900	63	180 ... 250	—	—	202000	226600	84300	192000
	316MR3C	90.7	5.5	110200	70	180 ... 250	—	—	202000	226600	84900	192000
	316MR3C	108	4.6	113600	61	180 ... 250	—	—	204100	229000	89900	192000
	316MR3C	114	4.4	101600	51	180 ... 250	—	—	205800	230800	91600	192000
	316MR3C	135	3.7	104500	44	180 ... 250	—	—	210900	236600	97000	192000
	316MR4	225	2.2	114300	30	132 ... 200	—	—	226800	254500	115000	192000
	316MR4	269	1.9	128800	28.3	132 ... 200	—	—	232600	261000	122000	192000
	316MR4	289	1.7	129400	26.5	132 ... 200	—	—	235100	263700	124900	192000
	316MR4	337	1.5	117400	20.6	132 ... 200	—	—	240300	269600	131500	192000
	316MR4	363	1.4	118300	19.3	132 ... 200	—	—	242800	272400	134800	192000
	316MR4	430	1.2	120300	16.5	132 ... 200	—	—	248800	279100	142700	192000
	316MR4	443	1.1	133300	17.8	132 ... 200	—	—	249800	280200	144000	192000
	316MR4	525	0.95	134400	15.1	132 ... 200	—	—	256000	287200	150000	192000
	316MR4	623	0.80	118100	11.2	132 ... 200	—	—	262400	294300	150000	192000
	316MR4	659	0.76	122200	11.0	132 ... 200	—	—	264400	296700	150000	192000
316MR4	782	0.64	122200	9.2	132 ... 200	—	—	271000	304000	150000	192000	

317M R



207490 Nm

n ₁ min ⁻¹		i	n ₂ min ⁻¹	M _{n2} Nm	P _{n1} kW	P (IEC)	Rn ₂ [N]					M _{2 max} Nm
							MC	MZ	HC/PC	HZ/PZ	FZ	
1500	317MR3B	49.8	30	47700	150	180 ... 250	—	—	225800	239800	48200	393000
	317MR3B	64.9	23.1	62100	150	180 ... 250	—	—	244400	259700	52700	393000
	317MR3B	78.1	19.2	74800	150	180 ... 250	—	—	258400	274500	56000	393000
	317MR3B	83.3	18.0	79700	150	180 ... 250	—	—	263400	279900	57200	393000
	317MR3B	100	15.0	96000	150	180 ... 250	—	—	278500	295900	60900	393000
	317MR3B	119	12.6	106600	150	180 ... 250	—	—	293200	311500	64400	393000
	317MR3C	68.9	21.8	60200	150	180 ... 250	—	—	248900	264400	53700	393000
	317MR3C	89.8	16.7	78400	150	180 ... 250	—	—	269500	286300	58700	393000
	317MR3C	108	13.9	94400	150	180 ... 250	—	—	284900	302700	62400	393000
	317MR3C	115	13.0	100600	150	180 ... 250	—	—	290400	308600	63800	393000
	317MR3C	139	10.8	121200	150	180 ... 250	—	—	307100	326200	67800	393000
	317MR3C	165	9.1	113100	118	180 ... 250	—	—	314300	333900	71800	393000
	317MR4	220	6.8	81500	66	132 ... 200	—	—	314300	333900	79000	393000
	317MR4	262	5.7	97200	66	132 ... 200	—	—	314300	333900	83800	393000
	317MR4	336	4.5	124700	66	132 ... 200	—	—	319400	339400	91100	393000
	317MR4	399	3.8	148000	66	132 ... 200	—	—	327400	347800	96500	393000
	317MR4	438	3.4	156700	63	132 ... 200	—	—	331800	352500	99500	393000
	317MR4	520	2.9	166200	57	132 ... 200	—	—	340000	361200	105400	393000
	317MR4	626	2.4	121500	34	132 ... 200	—	—	349100	370900	112100	393000
	317MR4	677	2.2	156000	41	132 ... 200	—	—	353000	375100	115000	393000
317MR4	803	1.9	155900	34	132 ... 200	—	—	361800	384300	121800	393000	
317MR4	953	1.6	139100	25.9	132 ... 200	—	—	370700	393900	129000	393000	
1000	317MR3B	49.8	20.1	53800	124	180 ... 250	—	—	255000	270900	55200	393000
	317MR3B	64.9	15.4	70200	124	180 ... 250	—	—	276100	293300	60300	393000
	317MR3B	78.1	12.8	84400	124	180 ... 250	—	—	291800	310000	64100	393000
	317MR3B	83.3	12.0	90000	124	180 ... 250	—	—	297500	316100	65500	393000
	317MR3B	100	10.0	108400	124	180 ... 250	—	—	314300	333900	69700	393000
	317MR3B	119	8.4	113300	109	180 ... 250	—	—	314300	333900	73800	393000
	317MR3C	68.9	14.5	67900	113	180 ... 250	—	—	281100	298600	61500	393000
	317MR3C	89.8	11.1	88600	113	180 ... 250	—	—	304400	323300	67200	393000
	317MR3C	108	9.2	106000	112	180 ... 250	—	—	314300	333900	71500	393000

B

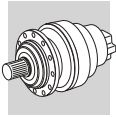

317M R



416

207490 Nm

n ₁ min ⁻¹		i	n ₂ min ⁻¹	M _{n2} Nm	P _{n1} kW	P (IEC)	R _{n2} [N]					M _{2 max} Nm	
							MC	MZ	HC/PC	HZ/PZ	FZ		
1000	317MR3C	115	8.7	113700	113	180 ... 250	—	—	314300	333900	73000	393000	
	317MR3C	139	7.2	135200	112	180 ... 250	—	—	314300	333900	77700	393000	
	317MR3C	165	6.1	113800	79	180 ... 250	—	—	314300	333900	82200	393000	
	317MR4	220	4.6	92000	50	132 ... 200	—	—	318500	338400	90500	393000	
	317MR4	262	3.8	109800	50	132 ... 200	—	—	326600	347000	96000	393000	
	317MR4	336	3.0	140900	50	132 ... 200	—	—	338500	359600	104300	393000	
	317MR4	399	2.5	167200	50	132 ... 200	—	—	346900	368500	110400	393000	
	317MR4	438	2.3	168200	45	132 ... 200	—	—	351600	373500	113900	393000	
	317MR4	520	1.9	170500	39	132 ... 200	—	—	360300	382700	120600	393000	
	317MR4	626	1.6	123500	23.3	132 ... 200	—	—	369900	393000	128300	393000	
	317MR4	677	1.5	156000	27.3	132 ... 200	—	—	374100	397400	131700	393000	
	317MR4	803	1.2	155900	23.0	132 ... 200	—	—	383400	407300	139400	393000	
	317MR4	953	1.0	149000	18.5	132 ... 200	—	—	392900	417400	147600	393000	
	500	317MR3B	49.8	10.0	66300	76	180 ... 250	—	—	313900	333500	69500	393000
		317MR3B	64.9	7.7	86400	76	180 ... 250	—	—	314300	333900	75900	393000
317MR3B		78.1	6.4	104000	76	180 ... 250	—	—	314300	333900	80800	393000	
317MR3B		83.3	6.0	110800	76	180 ... 250	—	—	314300	333900	82500	393000	
317MR3B		100	5.0	133400	76	180 ... 250	—	—	314400	334000	87800	393000	
317MR3B		119	4.2	117600	57	180 ... 250	—	—	322200	342300	92900	393000	
317MR3C		68.9	7.3	83600	70	180 ... 250	—	—	314300	333900	77500	393000	
317MR3C		89.8	5.6	109000	70	180 ... 250	—	—	314300	333900	84600	393000	
317MR3C		108	4.6	121300	64	180 ... 250	—	—	317800	337700	90000	393000	
317MR3C		115	4.3	139900	70	180 ... 250	—	—	320800	340800	92000	393000	
317MR3C		139	3.6	152200	63	180 ... 250	—	—	329400	349900	97800	393000	
317MR3C		165	3.0	124300	43	180 ... 250	—	—	337500	358600	103600	393000	
317MR4		220	2.3	112800	30	132 ... 200	—	—	351700	373600	114000	393000	
317MR4		262	1.9	135100	31	132 ... 200	—	—	360600	383100	120900	393000	
317MR4		336	1.5	173400	31	132 ... 200	—	—	373700	397000	131400	393000	
317MR4		399	1.3	186800	27.7	132 ... 200	—	—	383000	406900	139100	393000	
317MR4		438	1.1	177900	24.0	132 ... 200	—	—	388200	412400	143500	393000	
317MR4		520	0.96	179800	20.5	132 ... 200	—	—	397800	422600	150000	393000	
317MR4		626	0.80	125800	11.9	132 ... 200	—	—	408400	433900	150000	393000	
317MR4		677	0.74	156000	13.6	132 ... 200	—	—	413000	438800	150000	393000	
317MR4		803	0.62	155900	11.5	132 ... 200	—	—	423300	449700	150000	393000	
317MR4		953	0.52	150300	9.3	132 ... 200	—	—	433700	460800	150000	393000	

318M R



426

297550 Nm

n ₁ min ⁻¹		i	n ₂ min ⁻¹	M _{n2} Nm	P _{n1} kW	P (IEC)	R _{n2} [N]					M _{2 max} Nm	
							MC	MZ	HC/PC	HZ/PZ	FZ		
1500	318MR4B	225	6.7	208700	150	180 ... 250	—	—	299000	337600	106200	500000	
	318MR4B	288	5.2	231100	142	180 ... 250	—	—	299000	337600	115400	500000	
	318MR4B	342	4.4	237000	123	180 ... 250	—	—	304700	344000	122200	500000	
	318MR4B	362	4.1	239200	117	180 ... 250	—	—	307100	346800	124500	500000	
	318MR4B	430	3.5	246200	102	180 ... 250	—	—	314700	355400	131800	500000	
	318MR4B	499	3.0	249400	89	180 ... 250	—	—	321600	363100	138600	500000	
	318MR4C	311	4.8	233200	133	180 ... 250	—	—	300600	339400	118400	500000	
	318MR4C	399	3.8	243200	108	180 ... 250	—	—	311500	351700	128700	500000	
	318MR4C	474	3.2	250300	94	180 ... 250	—	—	319200	360400	136200	500000	
	318MR4C	501	3.0	252700	89	180 ... 250	—	—	321700	363300	138800	500000	
	318MR4C	595	2.5	260100	78	180 ... 250	—	—	329700	372300	146900	500000	
	318MR4C	691	2.2	257500	66	180 ... 250	—	—	336900	380400	154500	500000	
	1000	318MR4B	225	4.5	232800	123	180 ... 250	—	—	304000	343300	121600	500000
		318MR4B	288	3.5	246500	101	180 ... 250	—	—	315000	355700	132100	500000
		318MR4B	342	2.9	253800	88	180 ... 250	—	—	322900	364500	139900	500000
318MR4B		362	2.8	256200	84	180 ... 250	—	—	325400	367400	142500	500000	
318MR4B		430	2.3	263200	72	180 ... 250	—	—	333500	376500	150900	500000	

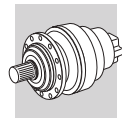

318M R



297550 Nm

n ₁ min ⁻¹		i	n ₂ min ⁻¹	M _{n2} Nm	P _{n1} kW	P (IEC)	Rn ₂ [N]					M ₂ max Nm
							MC	MZ	HC/PC	HZ/PZ	FZ	
1000	318MR4B	499	2.0	258200	61	180 ... 250	—	—	340700	384700	158700	500000
	318MR4C	311	3.2	249700	95	180 ... 250	—	—	318500	359600	135500	500000
	318MR4C	399	2.5	260500	77	180 ... 250	—	—	330000	372600	147300	500000
	318MR4C	474	2.1	267000	67	180 ... 250	—	—	338200	381900	155900	500000
	318MR4C	501	2.0	269200	64	180 ... 250	—	—	340900	384900	158800	500000
	318MR4C	595	1.7	276000	55	180 ... 250	—	—	349400	394500	168200	500000
	318MR4C	691	1.4	261200	45	180 ... 250	—	—	357000	403000	176800	500000
500	318MR4B	225	2.2	265000	70	180 ... 250	—	—	335700	379000	153200	500000
	318MR4B	288	1.7	274700	56	180 ... 250	—	—	347800	392700	166500	500000
	318MR4B	342	1.5	281600	49	180 ... 250	—	—	356500	402500	176300	500000
	318MR4B	362	1.4	283900	46	180 ... 250	—	—	359300	405700	179600	500000
	318MR4B	430	1.2	291100	40	180 ... 250	—	—	368200	415700	190100	500000
	318MR4B	499	1.0	264700	31	180 ... 250	—	—	376200	424800	199900	500000
	318MR4C	311	1.6	277800	53	180 ... 250	—	—	351600	397000	170700	500000
	318MR4C	399	1.3	288000	43	180 ... 250	—	—	364400	411400	185500	500000
	318MR4C	474	1.1	295200	37	180 ... 250	—	—	373400	421600	196400	500000
	318MR4C	501	1.0	297600	35	180 ... 250	—	—	376400	425000	200000	500000
	318MR4C	595	0.84	297600	29.6	180 ... 250	—	—	385700	435500	200000	500000
	318MR4C	691	0.72	264700	22.6	180 ... 250	—	—	394100	445000	200000	500000

319 R



471190 Nm

n ₁ min ⁻¹		i	n ₂ min ⁻¹	M _{n2} Nm	P _{n1} kW	P (IEC)	Rn ₂ [N]					M ₂ max Nm	
							MC	MZ	HC/PC	HZ/PZ	FZ		
1500	319R4B	249	6.0	231200	150	180 ... 250	—	—	363300	400000	109900	680000	
	319R4B	320	4.7	296700	150	180 ... 250	—	—	366600	403600	119400	680000	
	319R4B	379	4.0	334500	150	180 ... 250	—	—	375700	413600	126500	680000	
	319R4B	401	3.7	340200	150	180 ... 250	—	—	378700	416900	128800	680000	
	319R4B	475	3.2	294100	110	180 ... 250	—	—	387900	427100	136300	680000	
	319R4B	563	2.7	302600	95	180 ... 250	—	—	397500	437700	144300	680000	
	319R4B	655	2.3	308600	84	180 ... 250	—	—	406100	447200	151700	680000	
	319R4C	345	4.4	291900	150	180 ... 250	—	—	370600	408000	122500	680000	
	319R4C	442	3.4	350400	141	180 ... 250	—	—	384000	422800	133100	680000	
	319R4C	525	2.9	368800	125	180 ... 250	—	—	393500	433300	140900	680000	
	319R4C	555	2.7	375000	120	180 ... 250	—	—	396700	436800	143600	680000	
	319R4C	657	2.3	310500	84	180 ... 250	—	—	406300	447400	151900	680000	
	319R4C	780	1.9	319500	73	180 ... 250	—	—	416400	458500	160800	680000	
	319R4C	906	1.7	319200	62	180 ... 250	—	—	425500	468400	169100	680000	
	1000	319R4B	249	4.0	261100	124	180 ... 250	—	—	374800	412700	125800	680000
		319R4B	320	3.1	335100	124	180 ... 250	—	—	388400	427700	136700	680000
319R4B		379	2.6	377800	118	180 ... 250	—	—	398100	438300	144800	680000	
319R4B		401	2.5	384100	113	180 ... 250	—	—	401300	441800	147500	680000	
319R4B		475	2.1	314600	78	180 ... 250	—	—	411000	452500	156000	680000	
319R4B		563	1.8	323800	68	180 ... 250	—	—	421200	463800	165200	680000	
319R4B		655	1.5	321900	58	180 ... 250	—	—	430400	473800	173700	680000	
319R4C		345	2.9	329600	113	180 ... 250	—	—	392700	432300	140200	680000	
319R4C		442	2.3	392600	105	180 ... 250	—	—	406900	448000	152400	680000	
319R4C		525	1.9	400600	90	180 ... 250	—	—	417000	459100	161300	680000	
319R4C		555	1.8	413100	88	180 ... 250	—	—	420300	462800	164400	680000	
319R4C		657	1.5	332200	60	180 ... 250	—	—	430600	474100	173900	680000	
319R4C		780	1.3	341800	52	180 ... 250	—	—	441200	485800	184100	680000	
319R4C		906	1.1	333000	43	180 ... 250	—	—	450800	496400	193600	680000	
500	319R4B	249	2.0	321400	76	180 ... 250	—	—	413900	455700	158500	680000	
	319R4B	320	1.6	412200	76	180 ... 250	—	—	428900	472200	172300	680000	
	319R4B	379	1.3	424300	66	180 ... 250	—	—	439500	483900	182400	680000	
	319R4B	401	1.2	448500	66	180 ... 250	—	—	443000	487800	185800	680000	
	319R4B	475	1.1	353200	44	180 ... 250	—	—	453800	499700	196500	680000	
	319R4B	563	0.89	356300	37	180 ... 250	—	—	465000	512000	200000	680000	
	319R4B	655	0.76	336400	30	180 ... 250	—	—	475200	523200	200000	680000	

B

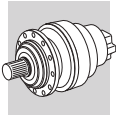

319 R



471190 Nm

n ₁ min ⁻¹		i	n ₂ min ⁻¹	M _{n2} Nm	P _{n1} kW	P (IEC)	Rn ₂ [N]					M _{2 max} Nm
							MC	MZ	HC/PC	HZ/PZ	FZ	
500	319R4C	345	1.5	405900	70	180 ... 250	—	—	433600	477300	176700	680000
	319R4C	442	1.1	458400	61	180 ... 250	—	—	449300	494700	192000	680000
	319R4C	525	0.95	443000	50	180 ... 250	—	—	460400	506900	200000	680000
	319R4C	555	0.90	471200	50	180 ... 250	—	—	464100	511000	200000	680000
	319R4C	657	0.76	356300	32	180 ... 250	—	—	475400	523400	200000	680000
	319R4C	780	0.64	356300	27.0	180 ... 250	—	—	487200	536400	200000	680000
	319R4C	906	0.55	336400	22.0	180 ... 250	—	—	497800	548000	200000	680000

321 R



655200 Nm

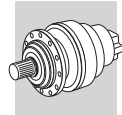

n ₁ min ⁻¹		i	n ₂ min ⁻¹	M _{n2} Nm	P _{n1} kW	P (IEC)	Rn ₂ [N]					M _{2 max} Nm	
							MC	MZ	HC/PC	HZ/PZ	FZ		
1500	321R4B	221	6.8	205600	150	180 ... 250	—	—	513900	611700	675800	934000	
	321R4B	288	5.2	265300	150	180 ... 250	—	—	513900	611700	731700	934000	
	321R4B	347	4.3	320600	150	180 ... 250	—	—	524700	624600	773600	934000	
	321R4B	370	4.1	341300	150	180 ... 250	—	—	529600	630300	788600	934000	
	321R4B	446	3.4	409600	150	180 ... 250	—	—	543800	647300	833700	934000	
	321R4B	529	2.8	484700	150	180 ... 250	—	—	557200	663300	877700	934000	
	321R4C	306	4.9	249000	144	180 ... 250	—	—	515400	613500	745100	934000	
	321R4C	399	3.8	324600	144	180 ... 250	—	—	535300	637200	806700	934000	
	321R4C	481	3.1	390700	144	180 ... 250	—	—	549700	654300	852900	934000	
	321R4C	512	2.9	416600	144	180 ... 250	—	—	554700	660300	869400	934000	
	321R4C	617	2.4	501400	144	180 ... 250	—	—	569600	678000	919200	934000	
	321R4C	732	2.0	521400	126	180 ... 250	—	—	583700	694800	967600	934000	
	1000	321R4B	221	4.5	233700	125	180 ... 250	—	—	521400	620600	763200	934000
		321R4B	288	3.5	304200	125	180 ... 250	—	—	541500	644500	826400	934000
		321R4B	347	2.9	361600	123	180 ... 250	—	—	556000	661800	873700	934000
321R4B		370	2.7	391600	125	180 ... 250	—	—	561100	667900	890600	934000	
321R4B		446	2.2	460100	122	180 ... 250	—	—	576200	685900	941500	934000	
321R4B		529	1.9	513000	115	180 ... 250	—	—	590500	702800	991200	934000	
321R4C		306	3.3	281200	109	180 ... 250	—	—	546200	650100	841500	934000	
321R4C		399	2.5	366600	109	180 ... 250	—	—	567200	675200	911100	934000	
321R4C		481	2.1	441300	109	180 ... 250	—	—	582500	693300	963200	934000	
321R4C		512	2.0	470500	109	180 ... 250	—	—	587800	699700	981900	934000	
321R4C		617	1.6	566500	109	180 ... 250	—	—	603600	718500	1038100	934000	
321R4C		732	1.4	529800	86	180 ... 250	—	—	618600	736300	1092800	934000	
500	321R4B	221	2.3	290300	78	180 ... 250	—	—	575600	685200	939600	934000	
	321R4B	288	1.7	379500	78	180 ... 250	—	—	597900	711600	1017400	934000	
	321R4B	347	1.4	450300	77	180 ... 250	—	—	613900	730700	1075600	934000	
	321R4B	370	1.4	483100	77	180 ... 250	—	—	619500	737400	1096500	934000	
	321R4B	446	1.1	567200	75	180 ... 250	—	—	636200	757200	1159200	934000	
	321R4B	529	0.95	536400	60	180 ... 250	—	—	651900	776000	1200000	934000	
	321R4C	306	1.6	346300	67	180 ... 250	—	—	603000	717800	1036000	934000	
	321R4C	399	1.3	451600	67	180 ... 250	—	—	626300	745500	1121700	934000	
	321R4C	481	1.0	543700	67	180 ... 250	—	—	643100	765500	1185800	934000	
	321R4C	512	0.98	575400	66	180 ... 250	—	—	649000	772500	1200000	934000	
	321R4C	617	0.81	655200	63	180 ... 250	—	—	666400	793300	1200000	934000	
	321R4C	732	0.68	536400	43	180 ... 250	—	—	682900	812900	1200000	934000	

B



25.5 3/V_M - PLANETARYWORM RATING CHARTS

Reading the rating chart.

3/V 10M L4							33640 Nm									
n_1 min ⁻¹		i	n_2 min ⁻¹	M_{n2} Nm	P_{n1} kW	P (IEC)		R_{n2} [N]								
								MC/PC	MZ/PZ	HC	HZ	FZ				
1500	3/V 10M L4	1617	0.93	28100	3.5	B5		—	—	99200	125800	65000	349			
	3/V 10M L4	1855	0.81	27100	3.0	71	80	90	100	112	—	—	101200	128300	65000	349
	3/V 10M L4	2016	0.74	29400	3.0	71	80	90	100	112	—	—	102400	129800	65000	349
	3/V 10M L4	2156	0.70	28100	2.7	71	80	90	100	112	—	—	103400	131100	65000	349
	3/V 10M L4	2455	0.61	27200	2.2	71	80	90	100	112	—	—	105300	133500	65000	349

1 Reference torque

2 Gearbox drive speed

3 Frame size of combined worm + planetary gearbox

4 Gear ratio

5 Gearbox output speed

Gearbox rated output torque based on:

6 - service factor $f_S=1$
- 10000 h theoretical lifetime

Gearbox rated input power, based on:

7 - service factor $f_S=1$
- 10000 h theoretical lifetime

8 Frame size of compatible IEC electric motor
- IEC inputs marked with * feature a lowered key.

Permitted overhung loading on output shaft, based on:

9 - service factor $f_S=1$
- 10000 h theoretical lifetime
- speed of output n_2

For forces not applied at shaft midpoint, see diagrams provided in the specific gearbox overall dimensioning pages

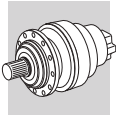

10 Dimensions page

B





3/V 00 L3

1250 Nm

n ₁ min ⁻¹		i	n ₂ min ⁻¹	M _{n2} Nm	P _{n1} kW	P (IEC) 	Rn ₂ [N]							
							MC/PC	MZ/PZ	HC	HZ	FZ			
							B5 / B14							
1500	3/V 00 L3	415	3.6	1000	0.57	63	71	80	6810	6810	22500	26200	5210	256
	3/V 00 L3	436	3.4	730	0.42	63	71	—	6860	6860	22700	26400	5300	256
	3/V 00 L3	509	2.9	1040	0.48	63	71	80	7010	7010	23200	27000	5580	256
	3/V 00 L3	562	2.7	720	0.30	63	71	80	7110	7110	23500	27300	5770	256
	3/V 00 L3	654	2.3	1090	0.41	63	71	—	7270	7270	24000	27900	6070	256
	3/V 00 L3	689	2.2	1100	0.37	63	71	80	7320	7320	24200	28200	6170	256
	3/V 00 L3	818	1.8	1110	0.36	63	71	—	7500	7500	24800	28900	6540	256
	3/V 00 L3	903	1.7	790	0.23	63	71	—	7610	7610	25200	29300	6760	256
	3/V 00 L3	997	1.5	800	0.18	63	71	80	7720	7720	25500	29700	6980	256
	3/V 00 L3	1107	1.4	1190	0.28	63	71	—	7830	7830	25900	30100	7230	256
	3/V 00 L3	1198	1.3	830	0.17	63	71	—	7920	7920	26200	30500	7420	256
	3/V 00 L3	1381	1.1	1230	0.24	63	71	—	8080	8080	26700	31100	7780	256
	3/V 00 L3	1495	1.0	860	0.14	63	71	—	8180	8180	27000	31400	7990	256
	3/V 00 L3	1869	0.80	860	0.12	63	71	—	8440	8440	27900	32500	8000	256
	3/V 00 L3	2337	0.64	860	0.10	63	71	—	8710	8710	28800	33500	8000	256



3/V 01 L3

2460 Nm

n ₁ min ⁻¹		i	n ₂ min ⁻¹	M _{n2} Nm	P _{n1} kW	P (IEC) 	Rn ₂ [N]							
							MC/PC	MZ/PZ	HC	HZ	FZ			
							B5 / B14							
1500	3/V 01 L3	430	3.5	1880	0.90	63	71	80	6840	6840	22600	24700	5270	266
	3/V 01 L3	443	3.4	1370	0.66	63	71	80	6870	6870	22700	24800	5330	266
	3/V 01 L3	509	2.9	1270	0.58	63	71	80	7010	7010	23200	25300	5580	266
	3/V 01 L3	562	2.7	1400	0.58	63	71	80	7110	7110	23500	25700	5770	266
	3/V 01 L3	654	2.3	1180	0.45	63	71	—	7270	7270	24000	26300	6070	266
	3/V 01 L3	689	2.2	1710	0.58	63	71	80	7320	7320	24200	26500	6170	266
	3/V 01 L3	799	1.9	1540	0.43	63	71	80	7480	7480	24700	27000	6480	266
	3/V 01 L3	903	1.7	1230	0.36	63	71	—	7610	7610	25200	27500	6760	266
	3/V 01 L3	997	1.5	1600	0.36	63	71	80	7720	7720	25500	27900	6980	266
	3/V 01 L3	1105	1.4	1990	0.45	63	71	—	7830	7830	25900	28300	7230	266
	3/V 01 L3	1198	1.3	1650	0.34	63	71	—	7920	7920	26200	28600	7420	266
	3/V 01 L3	1381	1.1	1880	0.36	63	71	—	8080	8080	26700	29200	7780	266
	3/V 01 L3	1495	1.0	1720	0.29	63	71	—	8180	8180	27000	29600	7990	266
	3/V 01 L3	1869	0.80	1720	0.24	63	71	—	8440	8440	27900	30500	8000	266
	3/V 01 L3	2337	0.64	1720	0.20	63	71	—	8710	8710	28800	31500	8000	266

3/V 03 L3

2970 Nm

n ₁ min ⁻¹		i	n ₂ min ⁻¹	M _{n2} Nm	P _{n1} kW	P (IEC) 	Rn ₂ [N]							
							MC/PC	MZ/PZ	HC	HZ	FZ			
							B5 / B14							
1500	3/V 03 L3	395	3.8	2210	1.2	71	80	90	21800	25000	42100	49900	15400	276
	3/V 03 L3	460	3.3	2310	1.1	71	80	90	22300	25500	43100	51000	16200	276
	3/V 03 L3	502	3.0	2020	0.83	71	80	90	22600	25800	43600	51700	16700	276
	3/V 03 L3	544	2.8	2730	1.1	71	80	90	22900	26100	44100	52300	17100	276
	3/V 03 L3	623	2.4	2220	0.80	71	80	90	23300	26600	45000	53300	17900	276
	3/V 03 L3	736	2.0	2720	0.83	71	80	90	23900	27300	46000	54600	18900	276
	3/V 03 L3	793	1.9	2180	0.62	71	80	90	24100	27600	46500	55100	19400	276
	3/V 03 L3	923	1.6	2670	0.65	71	80	90	24700	28200	47600	56400	20400	276
	3/V 03 L3	1023	1.5	2710	0.66	71	80	—	25000	28600	48300	57200	21100	276
	3/V 03 L3	1189	1.3	2340	0.49	71	80	—	25600	29200	49300	58400	22200	276
	3/V 03 L3	1385	1.1	2820	0.51	71	80	—	26100	29900	50400	59700	23400	276
	3/V 03 L3	1610	0.93	2440	0.38	71	80	—	26700	30500	51500	61000	24000	276
	3/V 03 L3	1728	0.87	2850	0.41	71	80	—	27000	30800	52000	61600	24000	276
	3/V 03 L3	2009	0.75	2440	0.30	71	80	—	27600	31500	53100	63000	24000	276
	3/V 03 L3	2511	0.60	2300	0.23	71	80	—	28400	32500	54900	65000	24000	276

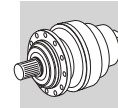

3/V 04 L3

3960 Nm

n ₁ min ⁻¹		i	n ₂ min ⁻¹	M _{n2} Nm	P _{n1} kW	P (IEC)	R _{n2} [N]					MC/PC	MZ/PZ	HC	HZ	FZ	
							B5	B5 / B14									
1500	3/V 04 L3	384	3.9	3510	1.9		71	80	90	100	112	21800	24900	41900	49700	15200	288
	3/V 04 L3	453	3.3	3730	1.7		71	80	90	100	112	22300	25500	43000	50900	16100	288
	3/V 04 L3	501	3.0	3010	1.4		71	80	90	100	112	22600	25800	43600	51700	16700	288
	3/V 04 L3	568	2.6	3160	1.2		71	80	90	100	112	23000	26300	44400	52600	17400	288
	3/V 04 L3	623	2.4	3530	1.2		71	80	90	100	112	23300	26600	45000	53300	17900	288
	3/V 04 L3	710	2.1	2640	0.73		71	80	90	100	112	23700	27100	45800	54300	18700	288
	3/V 04 L3	769	1.9	3330	0.90		71	80	90	100	112	24000	27500	46300	54900	19200	288
	3/V 04 L3	887	1.7	2740	0.61		71	80	90	100	112	24500	28000	47300	56000	20100	288
	3/V 04 L3	981	1.5	3860	0.91		71	80	90	100	112	24900	28400	48000	56900	20800	288
	3/V 04 L3	1152	1.3	3570	0.67		71	80	90	100	112	25500	29100	49100	58200	22000	288
	3/V 04 L3	1231	1.2	3610	0.68		71	80	90	100	112	25700	29400	49500	58700	22500	288
	3/V 04 L3	1419	1.1	2970	0.45		71	80	90	100	112	26200	30000	50600	59900	23600	288
	3/V 04 L3	1536	0.98	3740	0.56		71	80	90	100	112	26500	30300	51100	60600	24000	288
	3/V 04 L3	1774	0.85	3000	0.37		71	80	90	100	112	27100	30900	52200	61900	24000	288
	3/V 04 L3	1893	0.79	3000	0.37		71	80	90	100	112	27300	31200	52700	62400	24000	288
	3/V 04 L3	2366	0.63	3000	0.29		71	80	90	100	112	28200	32200	54400	64500	24000	288

3/V 05 L3

5800 Nm

n ₁ min ⁻¹		i	n ₂ min ⁻¹	M _{n2} Nm	P _{n1} kW	P (IEC)	R _{n2} [N]					MC/PC	MZ/PZ	HC	HZ	FZ	
							B5	B5 / B14									
1500	3/V 05 L3	396	3.8	3760	1.9		71	80	90	100	112	21900	25000	42100	50000	15400	300
	3/V 05 L3	462	3.3	4820	2.0		71	80	90	100	112	22300	25500	43100	51000	16200	300
	3/V 05 L3	529	2.8	3920	1.5		71	80	90	100	112	22800	26000	43900	52000	17000	300
	3/V 05 L3	576	2.6	4870	1.7		71	80	90	100	112	23100	26300	44500	52700	17400	300
	3/V 05 L3	623	2.4	4460	1.6		71	80	90	100	112	23300	26600	45000	53300	17900	300
	3/V 05 L3	715	2.1	4120	1.2		71	80	90	100	112	23800	27200	45900	54300	18800	300
	3/V 05 L3	793	1.9	4200	1.1		71	80	90	100	112	24100	27600	46500	55100	19400	300
	3/V 05 L3	894	1.7	4290	1.0		71	80	90	100	112	24500	28100	47300	56100	20200	300
	3/V 05 L3	1057	1.4	4410	0.97		71	80	90	100	112	25100	28700	48500	57500	21400	300
	3/V 05 L3	1116	1.3	4460	0.83		71	80	90	100	112	25300	29000	48900	57900	21700	300
	3/V 05 L3	1231	1.2	5470	1.0		71	80	90	100	112	25700	29400	49500	58700	22500	300
	3/V 05 L3	1431	1.0	4650	0.75		71	80	90	100	112	26300	30000	50600	60000	23600	300
	3/V 05 L3	1674	0.90	4430	0.57		71	80	90	100	112	26800	30700	51800	61400	24000	300
	3/V 05 L3	1786	0.84	4690	0.61		71	80	90	100	112	27100	31000	52300	61900	24000	300
	3/V 05 L3	2232	0.67	4430	0.46		71	80	90	100	112	28000	32000	53900	63900	24000	300

3/V 06 L3

10840 Nm

n ₁ min ⁻¹		i	n ₂ min ⁻¹	M _{n2} Nm	P _{n1} kW	P (IEC)	R _{n2} [N]					MC/PC	MZ/PZ	HC	HZ	FZ	
							B5	B5 / B14									
1500	3/V 06 L3	395	3.8	7590	3.8		71	80	90	100	112	26000	29600	59300	68400	22400	312
	3/V 06 L3	427	3.5	8820	4.1		71	80	90	100	112	26300	30000	59900	69200	23000	312
	3/V 06 L3	527	2.8	7590	2.9		71	80	90	100	112	27100	30900	61800	71300	24700	312
	3/V 06 L3	569	2.6	8560	3.0		71	80	90	100	112	27400	31200	62500	72100	25300	312
	3/V 06 L3	661	2.3	9370	2.8		71	80	90	100	112	28000	31900	63800	73700	26600	312
	3/V 06 L3	698	2.2	7540	2.1		71	80	90	100	112	28200	32200	64300	74200	27100	312
	3/V 06 L3	791	1.9	7680	2.1		71	80	90	100	112	28700	32700	65500	75600	28300	312
	3/V 06 L3	930	1.6	7890	1.7		71	80	90	100	112	29400	33500	67000	77300	29800	312
	3/V 06 L3	992	1.5	9450	2.1		71	80	90	100	112	29700	33800	67600	78100	30500	312
	3/V 06 L3	1153	1.3	8250	1.6		71	80	90	100	112	30300	34500	69100	79800	32100	312
	3/V 06 L3	1212	1.2	7820	1.5		71	80	90	100	112	30500	34800	69600	80300	32600	312
	3/V 06 L3	1395	1.1	8400	1.3		71	80	90	100	112	31100	35500	71000	82000	34200	312
	3/V 06 L3	1768	0.85	8630	1.1		71	80	90	100	112	32200	36700	73400	84800	35000	312
	3/V 06 L3	2139	0.70	8500	0.91		71	80	90	100	112	33100	37700	75500	87100	35000	312
	3/V 06 L3	2588	0.58	7000	0.62		71	80	90	100	112	34000	38800	77500	89500	35000	312



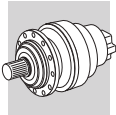

3/V 07 L3

15680 Nm

n ₁ min ⁻¹		i	n ₂ min ⁻¹	M _{n2} Nm	P _{n1} kW	P (IEC)	Rn ₂ [N]										
							MC/PC	MZ/PZ	HC	HZ	FZ						
1500	3/V 07 L3	386	3.9	9020	4.5	B5 / B14											
	3/V 07 L3	460	3.3	12300	5.3	80	90	100	112	132		31100	38900	70000	92100	28600	324
	3/V 07 L3	507	3.0	13600	5.3	80	90	100	112	132		31900	39900	71800	94400	30400	324
	3/V 07 L3	655	2.3	14400	4.8	80	90	100	112	132		32300	40400	72800	95700	31400	324
	3/V 07 L3	761	2.0	14200	4.0	80	90	100	112	132		33500	41900	75500	99300	34100	324
	3/V 07 L3	773	1.9	9970	2.6	80	90	100	112	132		34300	42800	77100	101400	35900	324
	3/V 07 L3	920	1.6	12300	2.9	80	90	100	112	132		34300	42900	77300	101600	36100	324
	3/V 07 L3	1015	1.5	14400	3.1	80	90	100	112	132		35200	44000	79200	104200	38200	324
	3/V 07 L3	1159	1.3	10600	2.0	80	90	100	112	132		35700	44600	80300	105700	39500	324
	3/V 07 L3	1288	1.2	14500	2.5	80	90	100	112	132		36400	45500	81900	107700	41300	324
	3/V 07 L3	1411	1.1	12300	2.0	80	90	100	112	132		36900	46200	83100	109300	42800	324
	3/V 07 L3	1545	0.97	11000	1.6	80	90	100	112	132		37400	46800	84200	110800	44100	324
	3/V 07 L3	1964	0.76	12300	1.5	80	90	100	112	132		37900	47400	85300	112200	45000	324
	3/V 07 L3	2150	0.70	11000	1.2	80	90	100	112	132		39200	49000	88300	116100	45000	324
	3/V 07 L3	2472	0.61	11000	1.1	80	90	100	112	132		39700	49700	89400	117600	45000	324
						80	90	100	112	132	40500	50700	91200	120000	45000	324	

3/V 09 L3

23240 Nm

n ₁ min ⁻¹		i	n ₂ min ⁻¹	M _{n2} Nm	P _{n1} kW	P (IEC)	Rn ₂ [N]									
							MC/PC	MZ/PZ	HC	HZ	FZ					
1500	3/V 09 L3	370	4.1	13000	7.3	B5										
	3/V 09 L3	442	3.4	17700	8.4	100	112	132	—	—		—	71100	91500	22600	336
	3/V 09 L3	507	3.0	14300	5.6	100	112	132	—	—		—	72900	93800	24000	336
	3/V 09 L3	655	2.3	17600	5.6	—	—	132	160	—		—	74400	95700	25100	336
	3/V 09 L3	761	2.0	14400	3.9	100	112	132	—	—		—	77100	99300	27300	336
	3/V 09 L3	800	1.9	21400	5.8	100	112	132	—	—		—	78800	101400	28700	336
	3/V 09 L3	840	1.8	20100	5.0	100	112	132	—	—		—	79400	102200	29200	336
	3/V 09 L3	840	1.8	20100	5.0	100	112	132	—	—		—	79900	102900	29700	336
	3/V 09 L3	1004	1.5	18100	3.9	100	112	132	—	—		—	82000	105500	31500	336
	3/V 09 L3	1159	1.3	16200	2.9	100	112	132	—	—		—	83700	107700	33000	336
	3/V 09 L3	1288	1.2	21500	3.6	100	112	132	—	—		—	85000	109300	34200	336
	3/V 09 L3	1497	1.0	18300	2.6	100	112	132	—	—		—	86800	111700	36000	336
	3/V 09 L3	1623	0.92	14700	2.1	100	112	—	—	—		—	87800	113000	36000	336
	3/V 09 L3	1792	0.84	22000	2.8	100	112	—	—	—		—	89100	114600	36000	336
	3/V 09 L3	2150	0.70	17000	1.7	100	112	132	—	—		—	91400	117600	36000	336
	3/V 09 L3	2472	0.61	17000	1.6	100	112	—	—	—		—	93300	120000	36000	336

3/V 10M L3

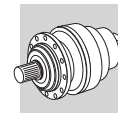

33640 Nm

n ₁ min ⁻¹		i	n ₂ min ⁻¹	M _{n2} Nm	P _{n1} kW	P (IEC)	Rn ₂ [N]									
							MC/PC	MZ/PZ	HC	HZ	FZ					
1500	3/V 10M L3	436	3.4	26700	12.2	B5										
	3/V 10M L3	507	3.0	24900	9.7	—	—	132	160 (*)	—		—	82300	104300	43100	348
	3/V 10M L3	560	2.7	25300	9.0	—	—	132	160 (*)	—		—	84100	106600	45300	348
	3/V 10M L3	614	2.4	19300	6.3	—	—	132	160 (*)	—		—	85300	108100	46800	348
	3/V 10M L3	701	2.1	20900	5.7	—	—	132	160 (*)	—		—	86400	109500	48300	348
	3/V 10M L3	773	1.9	21300	5.5	—	—	132	160 (*)	—		—	88100	111600	50400	348
	3/V 10M L3	920	1.6	19400	4.4	100	112	132	—	—		—	89300	113200	52100	348
	3/V 10M L3	1004	1.5	31800	6.9	100	112	132	—	—		—	91500	116100	55200	348
	3/V 10M L3	1120	1.3	28600	5.5	100	112	132	—	—		—	92700	117500	56900	348
	3/V 10M L3	1227	1.2	19400	3.4	100	112	132	—	—		—	94200	119400	59000	348
	3/V 10M L3	1411	1.1	19500	3.0	100	112	132	—	—		—	95400	120900	60800	348
							100	112	132	—		—	97300	123400	63700	348





3/V 10M L4

33640 Nm

n ₁ min ⁻¹		i	n ₂ min ⁻¹	M _{n2} Nm	P _{n1} kW	P (IEC) 	Rn ₂ [N]											
							MC/PC	MZ/PZ	HC	HZ	FZ							
1500	3/V 10M L4	1617	0.93	28100	3.5	B5	71	80	90	100	112	—	—	99200	125800	65000	349	
	3/V 10M L4	1855	0.81	27100	3.0		B5 / B14	71	80	90	100	112	—	—	101200	128300	65000	349
	3/V 10M L4	2016	0.74	29400	3.0		71	80	90	100	112	—	—	102400	129800	65000	349	
	3/V 10M L4	2156	0.70	28100	2.7		71	80	90	100	112	—	—	103400	131100	65000	349	
	3/V 10M L4	2455	0.61	27200	2.2		71	80	90	100	112	—	—	105300	133500	65000	349	
	3/V 10M L4	2987	0.50	30100	2.1		71	80	90	100	112	—	—	108300	137300	65000	349	
	3/V 10M L4	3273	0.46	27200	1.7		71	80	90	100	112	—	—	109700	139100	65000	349	
	3/V 10M L4	3570	0.42	30100	1.9		71	80	90	100	112	—	—	111100	140900	65000	349	
	3/V 10M L4	4036	0.37	30100	1.5		71	80	90	100	112	—	—	113100	143400	65000	349	
	3/V 10M L4	4637	0.32	30100	1.5		71	80	90	100	112	—	—	115300	146200	65000	349	
	3/V 10M L4	4959	0.30	28100	1.3		71	80	90	100	112	—	—	116400	147600	65000	349	



3/V 11M L3

49210 Nm

n ₁ min ⁻¹		i	n ₂ min ⁻¹	M _{n2} Nm	P _{n1} kW	P (IEC) 	Rn ₂ [N]										
							MC/PC	MZ/PZ	HC	HZ	FZ						
1500	3/V 11M L3	430	3.5	39100	17.9	B5	—	—	—	160	180 (*)	—	—	107800	134200	42800	360
	3/V 11M L3	510	2.9	32000	12.3		—	—	—	160	180 (*)	—	—	113400	141300	45400	360
	3/V 11M L3	551	2.7	40800	14.5		—	—	—	160	180 (*)	—	—	116100	144600	46600	360
	3/V 11M L3	644	2.3	40000	12.5		—	—	132	160	—	—	—	121700	151600	49000	360
	3/V 11M L3	720	2.1	41400	12.3		—	—	132	160	—	—	—	125800	156700	50900	360
	3/V 11M L3	827	1.8	43500	10.6		—	—	132	160	—	—	—	131100	163400	53300	360
	3/V 11M L3	900	1.7	41400	10.1		100	112	132	—	—	—	—	134500	167600	54800	360
	3/V 11M L3	1004	1.5	35700	8.0		100	112	132	—	—	—	—	139000	173200	56900	360
	3/V 11M L3	1103	1.4	45600	8.8		—	—	132	160	—	—	—	143000	178100	58700	360
	3/V 11M L3	1274	1.2	33200	5.7		100	112	132	—	—	—	—	149300	186000	61600	360
	3/V 11M L3	1378	1.1	47200	7.5		100	112	132	—	—	—	—	152900	190400	63200	360
	3/V 11M L3	1636	0.92	41300	5.5		100	112	132	—	—	—	—	157000	195000	65000	360
	3/V 11M L3	1963	0.76	41300	4.7		100	112	132	—	—	—	—	157000	195000	65000	360
	3/V 11M L3	2329	0.64	36500	3.5		100	112	132	—	—	—	—	157000	195000	65000	360

3/V 11M L4

49210 Nm



n ₁ min ⁻¹		i	n ₂ min ⁻¹	M _{n2} Nm	P _{n1} kW	P (IEC) 	Rn ₂ [N]										
							MC/PC	MZ/PZ	HC	HZ	FZ						
1500	3/V 11M L4	2663	0.56	47800	3.7	B5 / B14	80	90	100	112	132	—	—	133900	136600	65000	361
	3/V 11M L4	3063	0.49	47800	3.2		80	90	100	112	132	—	—	136600	139400	65000	361
	3/V 11M L4	3222	0.47	47800	3.0		80	90	100	112	132	—	—	137600	140400	65000	361
	3/V 11M L4	3557	0.42	42300	2.8		80	90	100	112	132	—	—	139500	142400	65000	361
	3/V 11M L4	4106	0.37	48900	2.8		80	90	100	112	132	—	—	142400	145300	65000	361
	3/V 11M L4	4410	0.34	47800	2.4		80	90	100	112	132	—	—	143900	146800	65000	361
	3/V 11M L4	5326	0.28	47800	2.0		80	90	100	112	132	—	—	147800	150800	65000	361

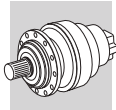



3/V 13M L3



60940 Nm

n ₁ min ⁻¹		i	n ₂ min ⁻¹	M _{n2} Nm	P _{n1} kW	P (IEC) 					Rn ₂ [N]					
						MC/PC	MZ/PZ	HC	HZ	FZ	MC/PC	MZ/PZ	HC	HZ	FZ	
B5																
1500	3/V 13M L3	370	4.1	39500	21	—	—	—	160	180 (*)	—	—	146300	171500	50200	372
	3/V 13M L3	425	3.5	45900	20	—	—	—	160	180 (*)	—	—	149300	174900	52600	372
	3/V 13M L3	516	2.9	48600	18.5	—	—	—	160	180 (*)	—	—	153500	179800	56100	372
	3/V 13M L3	567	2.6	48200	16.7	—	—	—	160	180 (*)	—	—	155500	182200	57800	372
	3/V 13M L3	673	2.2	49700	14.5	—	—	—	160	180 (*)	—	—	159400	186800	61200	372
	3/V 13M L3	741	2.0	45800	13.2	—	—	132	160	—	—	—	161600	189300	63200	372
	3/V 13M L3	810	1.9	36000	8.7	—	—	—	160	180 (*)	—	—	163600	191800	65100	372
	3/V 13M L3	870	1.7	53800	13.2	—	—	132	160	—	—	—	165300	193700	66700	372
	3/V 13M L3	1009	1.5	53300	10.6	—	—	132	160	—	—	—	168900	197900	70100	372
	3/V 13M L3	1088	1.4	51200	10.3	100	112	132	—	—	—	—	170700	200000	71900	372
	3/V 13M L3	1291	1.2	50400	8.6	100	112	132	—	—	—	—	174900	205000	76100	372
	3/V 13M L3	1418	1.1	56600	8.8	100	112	132	—	—	—	—	177300	207700	78500	372
	3/V 13M L3	1620	0.93	40100	5.3	—	—	132	160	—	—	—	180700	211700	80000	372
	3/V 13M L3	1682	0.89	57100	7.5	100	112	132	—	—	—	—	181700	212900	80000	372
	3/V 13M L3	2019	0.74	57100	6.4	100	112	132	—	—	—	—	186500	218500	80000	372
	3/V 13M L3	2430	0.62	40100	3.7	100	112	132	—	—	—	—	191500	224400	80000	372

B



3/V 13M L4

60940 Nm

n ₁ min ⁻¹		i	n ₂ min ⁻¹	M _{n2} Nm	P _{n1} kW	P (IEC) 					Rn ₂ [N]					
						MC/PC	MZ/PZ	HC	HZ	FZ	MC/PC	MZ/PZ	HC	HZ	FZ	
B5 / B14																
1500	3/V 13M L4	2773	0.54	59100	4.8	80	90	100	112	132	—	—	192000	228600	80000	373
	3/V 13M L4	3263	0.46	54100	3.4	80	90	100	112	132	—	—	192000	231000	80000	373
	3/V 13M L4	3515	0.43	57100	3.3	80	90	100	112	132	—	—	192000	231000	80000	373
	3/V 13M L4	4046	0.37	60900	3.4	80	90	100	112	132	—	—	192000	231000	80000	373
	3/V 13M L4	4536	0.33	57100	2.8	80	90	100	112	132	—	—	192000	231000	80000	373
	3/V 13M L4	5046	0.30	50800	2.3	80	90	100	112	132	—	—	192000	231000	80000	373

3/V 14M L3

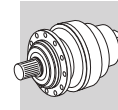

80640 Nm

n ₁ min ⁻¹		i	n ₂ min ⁻¹	M _{n2} Nm	P _{n1} kW	P (IEC) 					Rn ₂ [N]					
						MC/PC	MZ/PZ	HC	HZ	FZ	MC/PC	MZ/PZ	HC	HZ	FZ	
B5																
1500	3/V 14M L3	397	3.8	46100	22	—	—	—	160	180 (*)	—	—	137400	164800	57800	384
	3/V 14M L3	446	3.4	47700	21	—	—	—	160	180 (*)	—	—	139700	167500	60100	384
	3/V 14M L3	498	3.0	57800	22	—	—	—	160	180 (*)	—	—	141900	170200	62300	384
	3/V 14M L3	579	2.6	53700	17.6	—	—	—	160	180 (*)	—	—	145000	173900	65500	384
	3/V 14M L3	665	2.3	68100	20	—	—	—	160	180 (*)	—	—	147900	177300	68600	384
	3/V 14M L3	695	2.2	43000	13.2	—	—	132	160	—	—	—	148800	178500	69700	384
	3/V 14M L3	794	1.9	49300	12.5	—	—	132	160	—	—	—	151700	181900	72800	384
	3/V 14M L3	893	1.7	55200	13.2	—	—	132	160	—	—	—	154200	185000	75700	384
	3/V 14M L3	997	1.5	61900	12.5	—	—	132	160	—	—	—	156700	187900	78500	384
	3/V 14M L3	1116	1.3	52500	10.3	100	112	132	—	—	—	—	159200	191000	81500	384
	3/V 14M L3	1324	1.1	61500	10.2	100	112	132	—	—	—	—	163200	195700	86300	384
	3/V 14M L3	1339	1.1	47700	8.0	100	112	132	—	—	—	—	163400	196000	86700	384
	3/V 14M L3	1589	0.94	56600	8.0	100	112	132	—	—	—	—	167500	200900	90000	384
	3/V 14M L3	1662	0.90	73300	9.7	100	112	132	—	—	—	—	168600	202200	90000	384
	3/V 14M L3	1994	0.75	71000	8.0	100	112	132	—	—	—	—	173000	207500	90000	384
	3/V 14M L3	2318	0.65	63300	6.2	100	112	132	—	—	—	—	176800	212000	90000	384





3/V 14M L4

80640 Nm

n ₁ min ⁻¹		i	n ₂ min ⁻¹	M _{n2} Nm	P _{n1} kW	P (IEC) 	R _{n2} [N]					
							MC/PC	MZ/PZ	HC	HZ	FZ	
							B5					
1500	3/V 14M L4	2504	0.60	80600	7.2	100 112 132 —	—	—	178700	214300	90000	385
	3/V 14M L4	2782	0.54	80600	6.2	100 112 132 —	—	—	181400	217600	90000	385
	3/V 14M L4	3182	0.47	78000	5.1	100 112 132 —	—	—	185000	221800	90000	385
	3/V 14M L4	3472	0.43	73300	4.3	— — 132 160	—	—	187300	224600	90000	385
	3/V 14M L4	3993	0.38	73300	3.8	100 112 132 —	—	—	191100	229100	90000	385
	3/V 14M L4	4312	0.35	80600	4.2	100 112 132 —	—	—	193200	231700	90000	385
	3/V 14M L4	4959	0.30	80600	3.6	100 112 132 —	—	—	197100	236300	90000	385



3/V 15M L3

100800 Nm

n ₁ min ⁻¹		i	n ₂ min ⁻¹	M _{n2} Nm	P _{n1} kW	P (IEC) 	R _{n2} [N]					
							MC/PC	MZ/PZ	HC	HZ	FZ	
							B5					
1500	3/V 15M L3	386	3.9	62600	30	132 160 180 200 225	—	—	136900	164100	57300	396
	3/V 15M L3	446	3.4	65100	29	132 160 180 200 225	—	—	139700	167500	60100	396
	3/V 15M L3	498	3.0	82600	31	132 160 180 200 225	—	—	141900	170200	62300	396
	3/V 15M L3	560	2.7	81700	29	132 160 180 200 225	—	—	144300	173100	64800	396
	3/V 15M L3	665	2.3	85200	25	132 160 180 200 225	—	—	147900	177300	68600	396
	3/V 15M L3	840	1.8	80400	19.2	132 160 180 200 225	—	—	152900	183400	74200	396
	3/V 15M L3	997	1.5	88300	17.8	132 160 180 200 225	—	—	156700	187900	78500	396
	3/V 15M L3	1120	1.3	89200	17.1	132 160 180 200 225	—	—	159300	191100	81600	396
	3/V 15M L3	1329	1.1	90600	14.6	132 160 180 200 225	—	—	163300	195800	86400	396
	3/V 15M L3	1400	1.1	86900	13.6	132 160 180 200 225	—	—	164500	197300	88000	396
	3/V 15M L3	1662	0.90	91600	12.1	132 160 180 200 225	—	—	168600	202200	90000	396
	3/V 15M L3	1994	0.75	91600	10.5	132 160 180 200 225	—	—	173000	207500	90000	396
	3/V 15M L3	2318	0.65	79100	7.8	132 160 180 200 225	—	—	176800	212000	90000	396

3/V 15M L4

100800 Nm

n ₁ min ⁻¹		i	n ₂ min ⁻¹	M _{n2} Nm	P _{n1} kW	P (IEC) 	R _{n2} [N]					
							MC/PC	MZ/PZ	HC	HZ	FZ	
							B5					
1500	3/V 15M L4	2780	0.54	100800	7.4	— — 132 160 (*)	—	—	181400	217600	90000	397
	3/V 15M L4	3300	0.45	100800	6.3	— — 132 160 (*)	—	—	185900	223000	90000	397
	3/V 15M L4	3489	0.43	91600	5.4	— — 132 160 (*)	—	—	187400	224800	90000	397
	3/V 15M L4	4171	0.36	100800	5.2	100 112 132 —	—	—	192300	230600	90000	397
	3/V 15M L4	4950	0.30	100800	4.4	100 112 132 —	—	—	197000	236300	90000	397
	3/V 15M L4	5234	0.29	91600	3.8	100 112 132 —	—	—	198600	238200	90000	397

B

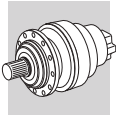

3/V 16M L3

134390 Nm

n ₁ min ⁻¹		i	n ₂ min ⁻¹	M _{n2} Nm	P _{n1} kW	P (IEC)	Rn ₂ [N]					
							MC/PC	MZ/PZ	HC	HZ	FZ	
							B5					
1500	3/V 16M L3	397	3.8	99700	48	132 160 180 200 225	—	—	210300	235900	96300	408
	3/V 16M L3	446	3.4	93400	41	132 160 180 200 225	—	—	213800	239800	100100	408
	3/V 16M L3	530	2.8	110900	41	132 160 180 200 225	—	—	219100	245800	106000	408
	3/V 16M L3	669	2.2	84000	25	132 160 180 200 225	—	—	226500	254100	114600	408
	3/V 16M L3	794	1.9	99700	25	132 160 180 200 225	—	—	232200	260400	121400	408
	3/V 16M L3	893	1.7	100800	24	132 160 180 200 225	—	—	236000	264800	126200	408
	3/V 16M L3	1059	1.4	116400	23	132 160 180 200 225	—	—	241900	271300	133600	408
	3/V 16M L3	1324	1.1	112100	18.6	132 160 180 200 225	—	—	249700	280100	143900	408
	3/V 16M L3	1589	0.94	112100	15.5	132 160 180 200 225	—	—	256300	287500	150000	408

B

3/V 16M L4

134390 Nm

n ₁ min ⁻¹		i	n ₂ min ⁻¹	M _{n2} Nm	P _{n1} kW	P (IEC)	Rn ₂ [N]					
							MC/PC	MZ/PZ	HC	HZ	FZ	
							B5					
1500	3/V 16M L4	1785	0.84	105900	12.2	— — 132 160 (*)	—	—	260600	292400	150000	409
	3/V 16M L4	1920	0.78	113900	12.2	— — 132 160 (*)	—	—	263300	295400	150000	409
	3/V 16M L4	2343	0.64	134400	11.8	— — 132 160 (*)	—	—	270900	303900	150000	409
	3/V 16M L4	2678	0.56	111600	9.0	100 112 132 —	—	—	276200	309800	150000	409
	3/V 16M L4	2880	0.52	120000	9.0	100 112 132 —	—	—	279000	313000	150000	409
	3/V 16M L4	3514	0.43	134400	8.2	100 112 132 —	—	—	287100	322100	150000	409
	3/V 16M L4	4171	0.36	134400	6.9	100 112 132 —	—	—	294200	330000	150000	409
	3/V 16M L4	4950	0.30	118100	5.1	100 112 132 —	—	—	301500	338200	150000	409

3/V 17M L3

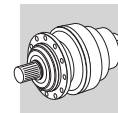

207490 Nm

n ₁ min ⁻¹		i	n ₂ min ⁻¹	M _{n2} Nm	P _{n1} kW	P (IEC)	Rn ₂ [N]					
							MC/PC	MZ/PZ	HC	HZ	FZ	
							B5					
1500	3/V 17M L3	405	3.7	120100	55	132 160 180 200 225	—	—	328100	348500	96900	418
	3/V 17M L3	425	3.5	106700	48	132 160 180 200 225	—	—	330400	351000	98500	418
	3/V 17M L3	512	2.9	128400	48	132 160 180 200 225	—	—	339200	360400	104800	418
	3/V 17M L3	567	2.6	118700	41	132 160 180 200 225	—	—	344200	365700	108500	418
	3/V 17M L3	608	2.5	128800	40	132 160 180 200 225	—	—	347600	369300	111000	418
	3/V 17M L3	683	2.2	142900	41	132 160 180 200 225	—	—	353500	375500	115400	418
	3/V 17M L3	810	1.9	135200	32	132 160 180 200 225	—	—	362200	384800	122100	418
	3/V 17M L3	851	1.8	106700	25	132 160 180 200 225	—	—	364700	387500	124200	418
	3/V 17M L3	1024	1.5	128400	25	132 160 180 200 225	—	—	374500	397900	132100	418
	3/V 17M L3	1134	1.3	128000	24	132 160 180 200 225	—	—	380100	403800	136600	418
	3/V 17M L3	1215	1.2	144900	24	132 160 180 200 225	—	—	383800	407800	139800	418
	3/V 17M L3	1365	1.1	154100	24	132 160 180 200 225	—	—	390300	414600	145400	418





3/V 17M L4

207490 Nm

n ₁ min ⁻¹		i	n ₂ min ⁻¹	M _{n2} Nm	P _{n1} kW	P (IEC) 					Rn ₂ [N]					
						MC/PC	MZ/PZ	HC	HZ	FZ	MC/PC	MZ/PZ	HC	HZ	FZ	
B5																
1500	3/V 17M L4	1780	0.84	184300	21	—	—	—	160	180 (*)	—	—	405300	430600	150000	419
	3/V 17M L4	2065	0.73	179800	17.0	—	—	—	160	180 (*)	—	—	414000	439800	150000	419
	3/V 17M L4	2485	0.60	125800	9.9	—	—	—	160	180 (*)	—	—	425100	451600	150000	419
	3/V 17M L4	2773	0.54	166400	13.2	—	—	132	160	—	—	—	431800	458800	150000	419
	3/V 17M L4	3168	0.47	190800	12.5	—	—	132	160	—	—	—	440100	467600	150000	419
	3/V 17M L4	3583	0.42	156000	8.8	—	—	—	160	180 (*)	—	—	442000	470000	150000	419
	3/V 17M L4	4129	0.36	179800	9.0	—	—	132	160	—	—	—	442000	470000	150000	419
	3/V 17M L4	4449	0.34	203000	10.3	100	112	132	—	—	—	—	442000	470000	150000	419
	3/V 17M L4	4970	0.30	125800	5.2	—	—	132	160	—	—	—	442000	470000	150000	419



3/V 18M L4

297550 Nm

n ₁ min ⁻¹		i	n ₂ min ⁻¹	M _{n2} Nm	P _{n1} kW	P (IEC) 					Rn ₂ [N]					
						MC/PC	MZ/PZ	HC	HZ	FZ	MC/PC	MZ/PZ	HC	HZ	FZ	
B5																
1500	3/V 18M L4	765	2.0	185000	47	132	160	180	200	225	—	—	341800	385900	159800	428
	3/V 18M L4	982	1.5	237400	47	132	160	180	200	225	—	—	354200	399900	173600	428
	3/V 18M L4	1165	1.3	281800	47	132	160	180	200	225	—	—	363000	409800	183800	428
	3/V 18M L4	1232	1.2	289200	45	132	160	180	200	225	—	—	365900	413100	187300	428
	3/V 18M L4	1473	1.0	255400	34	132	160	180	200	225	—	—	375300	423800	198800	428
	3/V 18M L4	1748	0.86	297600	33	132	160	180	200	225	—	—	384600	434200	200000	428
	3/V 18M L4	1848	0.81	297600	31	132	160	180	200	225	—	—	387700	437700	200000	428
	3/V 18M L4	2295	0.65	212900	19.2	132	160	180	200	225	—	—	399900	451500	200000	428
	3/V 18M L4	2464	0.61	297600	24	132	160	180	200	225	—	—	403900	456100	200000	428
	3/V 18M L4	2945	0.51	273300	19.2	132	160	180	200	225	—	—	414400	467900	200000	428
	3/V 18M L4	3495	0.43	297600	17.7	132	160	180	200	225	—	—	424600	479400	200000	428
	3/V 18M L4	3696	0.41	297600	16.7	132	160	180	200	225	—	—	428000	483300	200000	428
	3/V 18M L4	4386	0.34	297600	14.1	132	160	180	200	225	—	—	438600	495300	200000	428
	3/V 18M L4	5099	0.29	264700	10.8	132	160	180	200	225	—	—	448200	506000	200000	428

3/V 19 L4

471190 Nm



n ₁ min ⁻¹		i	n ₂ min ⁻¹	M _{n2} Nm	P _{n1} kW	P (IEC) 					Rn ₂ [N]					
						MC/PC	MZ/PZ	HC	HZ	FZ	MC/PC	MZ/PZ	HC	HZ	FZ	
B5																
1500	3/V 19 L4	2582	0.58	365200	29	132	160	180	200	225	—	—	494100	544000	200000	438
	3/V 19 L4	3231	0.46	356300	22	132	160	180	200	225	—	—	510200	561700	200000	438
	3/V 19 L4	4095	0.37	380000	19.2	132	160	180	200	225	—	—	527700	581100	200000	438
	3/V 19 L4	4457	0.34	336400	15.3	132	160	180	200	225	—	—	534200	588100	200000	438
	3/V 19 L4	5164	0.29	412400	17.6	132	160	180	200	225	—	—	545500	600600	200000	438

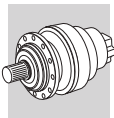



3/V 21 L4

655740 Nm

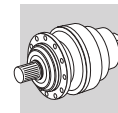

n ₁ min ⁻¹		i	n ₂ min ⁻¹	M _{n2} Nm	P _{n1} kW	P (IEC) 	Rn ₂ [N]									
							MC/PC	MZ/PZ	HC	HZ	FZ					
						B5					V					
1500	3/V 21 L4	1062	1.4	443000	79	132	160	180	200	225	—	—	615600	732700	1081800	448
	3/V 21 L4	1260	1.2	425500	65	132	160	180	200	225	—	—	630800	750900	1138800	448
	3/V 21 L4	1517	0.99	512200	65	132	160	180	200	225	—	—	647800	771000	1200000	448
	3/V 21 L4	1800	0.83	536400	57	132	160	180	200	225	—	—	663800	790100	1200000	448
	3/V 21 L4	1890	0.79	460000	48	132	160	180	200	225	—	—	668500	795700	1200000	448
	3/V 21 L4	2275	0.66	553700	48	132	160	180	200	225	—	—	686400	817000	1200000	448
	3/V 21 L4	2520	0.60	511700	41	132	160	180	200	225	—	—	696500	829000	1200000	448
	3/V 21 L4	2700	0.56	536400	39	132	160	180	200	225	—	—	703400	837300	1200000	448
	3/V 21 L4	3600	0.42	536400	30	132	160	180	200	225	—	—	732900	872400	1200000	448
	3/V 21 L4	3780	0.40	460000	25	132	160	180	200	225	—	—	738000	878500	1200000	448
	3/V 21 L4	4550	0.33	553700	25	132	160	180	200	225	—	—	757800	902100	1200000	448
	3/V 21 L4	5040	0.30	552000	24	132	160	180	200	225	—	—	769000	915300	1200000	448

B



25.6 3/A - COMBINED UNITS RATING CHARTS

Reading the rating chart.

3/A 00 L2						1250 Nm														
n_1 min ⁻¹		i	n_2 min ⁻¹	M_{n2} Nm	P_{n1} kW	P (IEC) 						R_{n2} [N]								
						MC/PC	MZ/PZ	HC	HZ	FZ										
1500	3/A 00 L2	19.1	78	470	4.3	63	71	80	90	100	112	—	—	—	3270	3270	11600	13500	1870	257
	3/A 00 L2	23.4	64	580	4.3	63	71	80	90	100	112	—	—	—	3500	3500	12300	14300	2000	257
	3/A 00 L2	31.7	47	650	3.5	63	71	80	90	100	112	—	—	—	3870	3870	13500	15700	2210	257
	3/A 00 L2	39.6	38	550	2.4	63	71	80	90	100	112	—	—	—	4170	4170	14400	16800	2380	257
	3/A 00 L2	41.5	36	650	2.7	63	71	80	90	100	112	—	—	—	4240	4240	14600	17000	2420	257

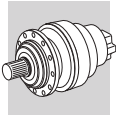

B

<p>1 Reference torque</p> <hr/> <p>2 Gearbox drive speed</p> <hr/> <p>3 Frame size of combined planetary + bevel helical unit</p> <hr/> <p>4 Gear ratio</p> <hr/> <p>5 Gearbox output speed</p> <hr/> <p>Gearbox rated output torque based on:</p> <p>6</p> <ul style="list-style-type: none"> - service factor $f_S=1$ - 10000 h theoretical lifetime <hr/> <p>Gearbox rated input power, based on:</p> <p>7</p> <ul style="list-style-type: none"> - service factor $f_S=1$ - 10000 h theoretical lifetime 	<p>8 Frame size of available IEC motor</p> <hr/> <p>Permitted overhung loading on output shaft, based on:</p> <p>9</p> <ul style="list-style-type: none"> - service factor $f_S=1$ - 10000 h theoretical lifetime - speed of output n_2 <p>For forces not applied at shaft midpoint, see diagrams provided in the specific gearbox overall dimensioning pages</p> <hr/> <p>10 Dimensions page</p>
---	---



3/A 00 L2



1250 Nm

n ₁ min ⁻¹		i	n ₂ min ⁻¹	M _{n2} Nm	P _{n1} kW	P (IEC) 										Rn ₂ [N]					
						MC/PC	MZ/PZ	HC	HZ	FZ											
1500	3/A 00 L2	19.1	78	470	4.3	63	71	80	90	100	112	—	—	—	3270	3270	11600	13500	1870	257	
	3/A 00 L2	23.4	64	580	4.3	63	71	80	90	100	112	—	—	—	3500	3500	12300	14300	2000	257	
	3/A 00 L2	31.7	47	650	3.5	63	71	80	90	100	112	—	—	—	3870	3870	13500	15700	2210	257	
	3/A 00 L2	39.6	38	550	2.4	63	71	80	90	100	112	—	—	—	4170	4170	14400	16800	2380	257	
	3/A 00 L2	41.5	36	650	2.7	63	71	80	90	100	112	—	—	—	4240	4240	14600	17000	2420	257	
	3/A 00 L2	51.8	28.9	550	1.8	63	71	80	90	100	112	—	—	—	4560	4560	15600	18200	2610	257	
	3/A 00 L2	61.2	24.5	650	1.8	63	71	80	90	100	112	—	—	—	4820	4820	16400	19100	2750	257	
	3/A 00 L2	71.0	21.1	650	1.6	63	71	80	90	100	112	—	—	—	5060	5060	17200	20000	2890	257	
	3/A 00 L2	80.2	18.7	650	1.4	63	71	80	90	100	112	—	—	—	5280	5280	17800	20700	3010	257	
	3/A 00 L2	88.6	16.9	550	1.1	63	71	80	90	100	112	—	—	—	5450	5450	18400	21300	3120	257	
	3/A 00 L2	100	15.0	550	0.95	63	71	80	90	100	112	—	—	—	5680	5680	19000	22100	3240	257	
	3/A 00 L2	107	14.0	650	1.0	63	71	80	90	100	112	—	—	—	5810	5810	19400	22600	3320	257	
	3/A 00 L2	134	11.2	550	0.71	63	71	80	90	100	112	—	—	—	6260	6260	20800	24200	3580	257	
	3/A 00 L2	171	8.8	550	0.55	63	71	80	90	100	112	—	—	—	6500	6500	21500	25000	3880	257	
	3/A 00 L2	203	7.4	650	0.55	63	71	80	90	100	112	—	—	—	6500	6500	21500	25000	4100	257	
	3/A 00 L2	219	6.9	620	0.49	63	71	80	90	100	112	—	—	—	6500	6500	21500	25000	4210	257	
	3/A 00 L2	253	5.9	550	0.37	63	71	80	90	100	112	—	—	—	6500	6500	21500	25000	4420	257	
	3/A 00 L2	296	5.1	650	0.38	63	71	80	90	100	112	—	—	—	6500	6500	21500	25000	4660	257	
	3/A 00 L2	319	4.7	440	0.24	63	71	—	—	—	—	—	—	6560	6560	21700	25200	4770	257		
	3/A 00 L2	369	4.1	560	0.26	63	71	80	90	100	112	—	—	—	6700	6700	22100	25800	5010	257	
	3/A 00 L2	391	3.8	540	0.24	63	71	—	—	—	—	—	—	6750	6750	22300	26000	5110	257		
	3/A 00 L2	441	3.4	690	0.27	63	71	—	—	—	—	—	—	6870	6870	22700	26400	5320	257		
	3/A 00 L2	550	2.7	590	0.19	63	71	—	—	—	—	—	—	7090	7090	23400	27300	5730	257		
	3/A 00 L2	660	2.3	610	0.16	63	71	—	—	—	—	—	—	7270	7270	24100	28000	6080	257		

B

3/A 01 L2

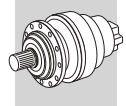

2460 Nm

n ₁ min ⁻¹		i	n ₂ min ⁻¹	M _{n2} Nm	P _{n1} kW	P (IEC) 										Rn ₂ [N]					
						MC/PC	MZ/PZ	HC	HZ	FZ											
1500	3/A 01 L2	18.8	80	710	6.5	—	—	80	90	100	112	—	—	—	3250	3250	11500	12600	1860	267	
	3/A 01 L2	23.0	65	870	6.5	—	—	80	90	100	112	—	—	—	3480	3480	12300	13400	1990	267	
	3/A 01 L2	31.2	48	1180	6.5	—	—	80	90	100	112	—	—	—	3850	3850	13400	14700	2200	267	
	3/A 01 L2	35.8	42	760	3.7	—	—	80	90	100	112	—	—	—	4030	4030	14000	15300	2300	267	
	3/A 01 L2	40.1	37	870	3.7	63	71	80	90	100	112	—	—	—	4190	4190	14500	15800	2390	267	
	3/A 01 L2	43.9	34	930	3.7	—	—	80	90	100	112	—	—	—	4320	4320	14900	16300	2470	267	
	3/A 01 L2	49.1	31	830	2.9	63	71	80	90	100	112	—	—	—	4480	4480	15400	16800	2560	267	
	3/A 01 L2	54.2	27.7	1180	3.7	63	71	80	90	100	112	—	—	—	4630	4630	15800	17300	2650	267	
	3/A 01 L2	59.4	25.2	1260	3.7	—	—	80	90	100	112	—	—	—	4770	4770	16300	17800	2730	267	
	3/A 01 L2	74.2	20.2	1150	2.7	—	—	80	90	100	112	—	—	—	5140	5140	17400	19000	2940	267	
	3/A 01 L2	81.3	18.4	1300	2.8	63	71	80	90	100	112	—	—	—	5300	5300	17900	19600	3030	267	
	3/A 01 L2	102	14.8	1150	2.0	63	71	80	90	100	112	—	—	—	5710	5710	19100	20900	3260	267	
	3/A 01 L2	133	11.3	1300	1.7	63	71	80	90	100	112	—	—	—	6250	6250	20800	22700	3570	267	
	3/A 01 L2	166	9.0	1150	1.2	63	71	80	90	100	112	—	—	—	6500	6500	21500	23500	3840	267	
	3/A 01 L2	184	8.1	1030	0.97	63	71	80	90	100	112	—	—	—	6500	6500	21500	23500	3980	267	
	3/A 01 L2	204	7.3	1300	1.1	63	71	80	90	100	112	—	—	—	6500	6500	21500	23500	4120	267	
	3/A 01 L2	220	6.8	830	0.65	63	71	80	90	100	112	—	—	—	6500	6500	21500	23500	4220	267	
	3/A 01 L2	255	5.9	1150	0.78	63	71	80	90	100	112	—	—	—	6500	6500	21500	23500	4430	267	
	3/A 01 L2	269	5.6	1010	0.65	63	71	80	90	100	112	—	—	—	6500	6500	21500	23500	4510	267	
	3/A 01 L2	311	4.8	1150	0.64	63	71	80	90	100	112	—	—	—	6530	6530	21600	23600	4740	267	
	3/A 01 L2	364	4.1	1340	0.64	63	71	80	90	100	112	—	—	—	6680	6680	22100	24200	4990	267	
	3/A 01 L2	393	3.8	830	0.36	63	71	—	—	—	—	—	—	6760	6760	22300	24400	5120	267		
	3/A 01 L2	454	3.3	1150	0.44	63	71	80	90	100	112	—	—	—	6900	6900	22800	24900	5370	267	
	3/A 01 L2	533	2.8	1120	0.36	63	71	—	—	—	—	—	—	7060	7060	23300	25500	5660	267		
	3/A 01 L2	665	2.3	1150	0.30	63	71	—	—	—	—	—	—	7280	7280	24100	26300	6100	267		



3/A 03 L2



2970 Nm

n ₁ min ⁻¹		i	n ₂ min ⁻¹	M _{n2} Nm	P _{n1} kW	P (IEC) 								Rn ₂ [N]						
						MC/PC	MZ/PZ	HC	HZ	FZ										
1500	3/A 03 L2	19.4	77	1050	9.3	—	—	80	90	100	112	—	—	—	10600	12100	21900	26000	5640	277
	3/A 03 L2	23.0	65	1240	9.3	—	—	80	90	100	112	—	—	—	11200	12800	23100	27300	5960	277
	3/A 03 L2	28.8	52	1550	9.3	—	—	80	90	100	112	—	—	—	12100	13800	24700	29300	6430	277
	3/A 03 L2	33.5	45	1800	9.3	—	—	80	90	100	112	—	—	—	12700	14600	25800	30600	6760	277
	3/A 03 L2	40.5	37	1650	7.0	—	—	80	90	100	112	—	—	—	13600	15500	27300	32400	7200	277
	3/A 03 L2	43.4	35	1800	7.2	—	—	80	90	100	112	—	—	—	13900	15900	27900	33100	7370	277
	3/A 03 L2	52.5	28.6	1650	5.4	—	—	80	90	100	112	—	—	—	14800	16900	29600	35000	7850	277
	3/A 03 L2	52.5	28.6	1650	5.4	—	—	80	90	100	112	—	—	—	14800	16900	29600	35000	7850	277
	3/A 03 L2	62.9	23.8	1550	4.2	63	71	80	90	100	112	—	—	—	15700	18000	31200	37000	8340	277
	3/A 03 L2	73.2	20.5	1800	4.2	63	71	80	90	100	112	—	—	—	16500	18900	32700	38700	8770	277
	3/A 03 L2	88.5	16.9	1650	3.2	63	71	80	90	100	112	—	—	—	17600	20100	34600	41000	9340	277
	3/A 03 L2	96.9	15.5	1690	3.0	63	71	80	90	100	112	—	—	—	18200	20700	35500	42100	9630	277
	3/A 03 L2	182	8.3	1830	1.7	63	71	80	90	100	112	—	—	—	21000	24000	40500	48000	11900	277
	3/A 03 L2	220	6.8	1650	1.3	63	71	80	90	100	112	—	—	—	21000	24000	40500	48000	12700	277
	3/A 03 L2	269	5.6	1840	1.2	63	71	80	90	100	112	—	—	—	21000	24000	40500	48000	13500	277
	3/A 03 L2	269	5.6	1840	1.2	63	71	80	90	100	112	—	—	—	21000	24000	40500	48000	13500	277
	3/A 03 L2	326	4.6	1660	0.88	63	71	80	90	100	112	—	—	—	21200	24300	41000	48600	14400	277
	3/A 03 L2	352	4.3	2020	0.99	63	71	80	90	100	112	—	—	—	21500	24600	41400	49100	14800	277
	3/A 03 L2	409	3.7	1940	0.82	63	71	80	90	100	112	—	—	—	22000	25100	42300	50200	15600	277
	3/A 03 L2	495	3.0	1720	0.60	63	71	80	90	100	112	—	—	—	22600	25800	43500	51600	16600	277
3/A 03 L2	574	2.6	1740	0.52	63	71	80	90	100	112	—	—	—	23000	26300	44400	52700	17400	277	
3/A 03 L2	605	2.5	1800	0.51	63	71	80	90	100	112	—	—	—	23200	26500	44800	53100	17700	277	
3/A 03 L2	731	2.1	1800	0.42	63	71	80	90	100	112	—	—	—	23900	27300	46000	54500	18900	277	

B

3/A 04 L2

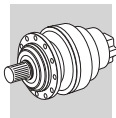

3960 Nm

n ₁ min ⁻¹		i	n ₂ min ⁻¹	M _{n2} Nm	P _{n1} kW	P (IEC) 								Rn ₂ [N]						
						MC/PC	MZ/PZ	HC	HZ	FZ										
1500	3/A 04 L2	18.7	80	1920	17.7	—	—	80	90	100	112	132	—	—	10500	12000	21700	25700	5570	289
	3/A 04 L2	22.1	68	2270	17.7	—	—	80	90	100	112	132	—	—	11100	12700	22800	27000	5880	289
	3/A 04 L2	25.6	59	1920	12.9	—	—	80	90	100	112	132	—	—	11600	13300	23800	28200	6180	289
	3/A 04 L2	27.7	54	2830	17.6	—	—	80	90	100	112	132	—	—	12000	13700	24400	28900	6350	289
	3/A 04 L2	30.2	50	2270	12.9	—	—	80	90	100	112	132	—	—	12300	14100	25000	29700	6530	289
	3/A 04 L2	35.3	43	2270	11.1	—	—	80	90	100	112	132	—	—	13000	14800	26200	31100	6880	289
	3/A 04 L2	39.1	38	2270	10.0	—	—	80	90	100	112	132	—	—	13400	15300	27100	32100	7120	289
	3/A 04 L2	44.3	34	2850	11.1	—	—	80	90	100	112	132	—	—	14000	16000	28100	33300	7420	289
	3/A 04 L2	49.7	30	2270	7.9	63	71	80	90	100	112	132	—	—	14500	16600	29100	34500	7710	289
	3/A 04 L2	54.5	27.5	2390	7.5	—	—	80	90	100	112	132	—	—	15000	17100	29900	35400	7950	289
	3/A 04 L2	62.4	24.0	2850	7.9	63	71	80	90	100	112	132	—	—	15700	17900	31100	36900	8320	289
	3/A 04 L2	68.4	21.9	2510	6.3	—	—	80	90	100	112	132	—	—	16200	18500	32000	37900	8580	289
	3/A 04 L2	81.7	18.4	2370	5.0	63	71	80	90	100	112	132	—	—	17200	19600	33800	40000	9100	289
	3/A 04 L2	90.7	16.5	2390	4.5	—	—	80	90	100	112	132	—	—	17800	20300	34800	41300	9420	289
	3/A 04 L2	102	14.7	2550	4.3	63	71	80	90	100	112	132	—	—	18500	21100	36100	42700	9790	289
	3/A 04 L2	117	12.8	2390	3.5	—	—	80	90	100	112	132	—	—	19300	22100	37600	44500	10300	289
	3/A 04 L2	129	11.6	2720	3.6	63	71	80	90	100	112	132	—	—	20000	22800	38700	45900	10600	289
	3/A 04 L2	149	10.1	2390	2.8	63	71	80	90	100	112	132	—	—	21000	24000	40400	47900	11100	289
	3/A 04 L2	162	9.2	2900	3.1	63	71	80	90	100	112	132	—	—	21000	24000	40500	48000	11400	289
	3/A 04 L2	174	8.6	2970	2.9	63	71	80	90	100	112	—	—	—	21000	24000	40500	48000	11700	289
	3/A 04 L2	205	7.3	3500	2.9	63	71	80	90	100	112	—	—	—	21000	24000	40500	48000	12400	289
	3/A 04 L2	226	6.6	3500	2.7	63	71	80	90	100	112	—	—	—	21000	24000	40500	48000	12800	289
	3/A 04 L2	250	6.0	3500	2.4	63	71	80	90	100	112	—	—	—	21000	24000	40500	48000	13200	289
	3/A 04 L2	283	5.3	2850	1.7	63	71	80	90	100	112	—	—	—	21000	24000	40500	48000	13800	289
	3/A 04 L2	317	4.7	2400	1.3	63	71	80	90	100	112	—	—	—	21200	24200	40800	48400	14300	289
	3/A 04 L2	349	4.3	2430	1.2	63	71	80	90	100	112	—	—	—	21500	24500	41400	49000	14800	289
	3/A 04 L2	386	3.9	2450	1.1	63	71	80	90	100	112	—	—	—	21800	24900	42000	49800	15300	289
	3/A 04 L2	469	3.2	2500	0.92	63	71	80	90	100	112	—	—	—	22400	25600	43200	51200	16300	289
	3/A 04 L2	520	2.9	2520	0.84	63	71	80	90	100	112	—	—	—	22700	26000	43800	51900	16900	289



3/A 05 L2



5800 Nm

n ₁ min ⁻¹		i	n ₂ min ⁻¹	M _{n2} Nm	P _{n1} kW	P (IEC) 								Rn ₂ [N]						
						MC/PC	MZ/PZ	HC	HZ	FZ										
1500	3/A 05L2	18.7	80	1920	17.7	—	—	80	90	100	112	132	—	—	10500	12000	21700	25700	5570	301
	3/A 05L2	22.1	68	2270	17.7	—	—	80	90	100	112	132	—	—	11100	12700	22800	27000	5880	301
	3/A 05L2	27.7	54	2850	17.7	—	—	80	90	100	112	132	—	—	12000	13700	24400	28900	6350	301
	3/A 05L2	32.2	47	3310	17.7	—	—	80	90	100	112	132	—	—	12600	14400	25500	30300	6670	301
	3/A 05L2	39.0	38	3020	13.3	—	—	80	90	100	112	132	—	—	13400	15300	27000	32000	7110	301
	3/A 05L2	44.0	34	3310	12.9	—	—	80	90	100	112	132	—	—	14000	15900	28000	33200	7400	301
	3/A 05L2	53.3	28.2	3040	9.8	—	—	80	90	100	112	132	—	—	14900	17000	29700	35200	7890	301
	3/A 05L2	57.0	26.3	3310	10.0	—	—	80	90	100	112	132	—	—	15200	17400	30300	35900	8070	301
	3/A 05L2	62.6	24.0	3220	8.9	—	—	80	90	100	112	132	—	—	15700	17900	31200	36900	8330	301
	3/A 05L2	72.5	20.7	3310	7.9	63	71	80	90	100	112	132	—	—	16500	18800	32600	38600	8740	301
	3/A 05L2	75.8	19.8	3060	7.0	—	—	80	90	100	112	132	—	—	16700	19100	33000	39100	8870	301
	3/A 05L2	85.6	17.5	3520	7.1	—	—	80	90	100	112	132	—	—	17400	19900	34200	40600	9240	301
	3/A 05L2	104	14.5	3080	5.1	—	—	80	90	100	112	132	—	—	18600	21200	36200	42900	9840	301
	3/A 05L2	121	12.4	3520	5.0	63	71	80	90	100	112	132	—	—	19600	22300	38000	45000	10400	301
	3/A 05L2	141	10.7	3600	4.4	63	71	80	90	100	112	132	—	—	20600	23500	39700	47100	10900	301
	3/A 05L2	162	9.2	2900	3.1	63	71	80	90	100	112	132	—	—	21000	24000	40500	48000	11400	301
	3/A 05L2	175	8.5	3600	3.5	63	71	80	90	100	112	132	—	—	21000	24000	40500	48000	11700	301
	3/A 05L2	212	7.1	3100	2.5	63	71	80	90	100	112	132	—	—	21000	24000	40500	48000	12500	301
	3/A 05L2	212	7.1	3100	2.5	63	71	80	90	100	112	132	—	—	21000	24000	40500	48000	12500	301
	3/A 05L2	241	6.2	4290	3.1	63	71	80	90	100	112	132	—	—	21000	24000	40500	48000	13000	301
	3/A 05L2	280	5.4	3600	2.2	63	71	80	90	100	112	132	—	—	21000	24000	40500	48000	13700	301
	3/A 05L2	329	4.6	3650	1.9	63	71	80	90	100	112	—	—	—	21300	24300	41000	48600	14500	301
	3/A 05L2	398	3.8	3180	1.4	63	71	80	90	100	112	—	—	—	21900	25000	42200	50000	15400	301
	3/A 05L2	422	3.6	4400	1.8	63	71	80	90	100	112	—	—	—	22100	25200	42500	50400	15700	301
	3/A 05L2	491	3.1	3880	1.4	63	71	80	90	100	112	—	—	—	22500	25800	43500	51500	16500	301
	3/A 05L2	594	2.5	3300	0.96	63	71	80	90	100	112	—	—	—	23200	26500	44700	52900	17600	301

B

3/A 06 L2

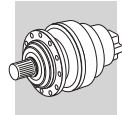

10840 Nm

n ₁ min ⁻¹		i	n ₂ min ⁻¹	M _{n2} Nm	P _{n1} kW	P (IEC) 												Rn ₂ [N]					
						MC/PC	MZ/PZ	HC	HZ	FZ													
1500	3/A 06L2	27.7	54	3320	21	—	—	80	90	100	112	132	160	180	14200	16200	34300	39600	9250	313			
	3/A 06L2	32.7	46	3920	21	—	—	80	90	100	112	132	160	180	15000	17200	36100	41700	9780	313			
	3/A 06L2	34.9	43	3490	17.2	—	—	80	90	100	112	132	160	180	15400	17500	36800	42500	9990	313			
	3/A 06L2	41.1	37	4910	21	—	—	80	90	100	112	132	160	180	16200	18500	38600	44600	10500	313			
	3/A 06L2	47.2	32	3840	14.0	—	—	80	90	100	112	132	160	180	17000	19400	40300	46500	11000	313			
	3/A 06L2	51.7	29.0	5170	17.2	—	—	80	90	100	112	132	160	180	17500	20000	41400	47800	11400	313			
	3/A 06L2	55.7	26.9	4530	14.0	—	—	80	90	100	112	132	160	180	18000	20500	42300	48900	11700	313			
	3/A 06L2	60.1	24.9	6010	17.2	—	—	80	90	100	112	132	160	180	18400	21000	43300	50000	12000	313			
	3/A 06L2	69.9	21.5	5690	14.0	—	—	80	90	100	112	132	160	180	19400	22100	45300	52300	12600	313			
	3/A 06L2	81.2	18.5	6480	13.8	—	—	80	90	100	112	132	160	180	20400	23200	47400	54700	13200	313			
	3/A 06L2	88.5	16.9	6210	12.1	—	—	80	90	100	112	132	160	180	21000	23900	48700	56200	13600	313			
	3/A 06L2	98.3	15.3	5380	9.4	—	—	80	90	100	112	132	160	180	21700	24800	50200	58000	14100	313			
	3/A 06L2	112	13.4	6180	9.8	—	—	80	90	100	112	132	160	180	22700	25900	52200	60300	14700	313			
	3/A 06L2	125	12.0	5440	7.5	—	—	80	90	100	112	132	160	180	23500	26800	53900	62200	15300	313			
	3/A 06L2	141	10.7	7760	9.8	—	—	80	90	100	112	132	160	180	24500	27900	55900	64600	15900	313			
	3/A 06L2	164	9.2	6500	7.1	—	—	80	90	100	112	132	160	180	25000	28500	57000	65800	16700	313			
	3/A 06L2	190	7.9	7760	7.3	—	—	80	90	100	112	132	160	180	25000	28500	57000	65800	17600	313			
	3/A 06L2	198	7.6	5500	4.9	—	—	80	90	100	112	132	160	180	25000	28500	57000	65800	17800	313			
	3/A 06L2	221	6.8	6520	5.3	—	—	80	90	100	112	132	160	180	25000	28500	57000	65800	18500	313			
	3/A 06L2	267	5.6	5500	3.7	—	—	80	90	100	112	132	160	180	25000	28500	57000	65800	19700	313			
	3/A 06L2	276	5.4	7760	5.0	63	71	80	90	100	112	132	160	180	25000	28500	57000	65800	19900	313			
	3/A 06L2	321	4.7	6610	3.7	63	71	80	90	100	112	132	160	180	25200	28800	57500	66400	20900	313			
	3/A 06L2	388	3.9	5640	2.6	63	71	80	90	100	112	132	160	180	25900	29600	59100	68300	22300	313			
	3/A 06L2	380	3.9	6180	2.9	63	71	80	90	100	112	132	160	180	25900	29500	59000	68100	22200	313			
	3/A 06L2	435	3.5	7760	3.2	63	71	80	90	100	112	132	160	180	26400	30100	60100	69400	23200	313			
	3/A 06L2	505	3.0	7150	2.5	63	71	80	90	100	112	132	160	180	26900	30700	61400	70900	24400	313			
	3/A 06L2	555	2.7	7270	2.3	63	71	80	90	100	112	132	160	180	27300	31100	62200	71800	25100	313			
	3/A 06L2	611	2.5	5920	1.7	63	71	80	90	100	112	132	160	180	27700	31600	63100	72800	25900	313			
	3/A 06L2	671	2.2	6020	1.6	63	71	80	90	100	112	132	160	180	28000	32000	64000	73800	26800	313			



3/A 07 L2

15680 Nm

n ₁ min ⁻¹		i	n ₂ min ⁻¹	M _{n2} Nm	P _{n1} kW	P (IEC) 												Rn ₂ [N]					
						MC/PC	MZ/PZ	HC	HZ	FZ	MC/PC	MZ/PZ	HC	HZ	FZ								
1500	3/A 07L2	27.1	55	6650	42	—	—	—	—	—	—	132	160	180	17000	21200	40400	53100	11800	325			
	3/A 07L2	32.3	46	7940	42	—	—	—	—	—	—	132	160	180	18000	22500	42600	56000	12500	325			
	3/A 07L2	41.5	36	9620	40	—	—	—	—	—	—	132	160	180	19500	24400	45900	60400	13600	325			
	3/A 07L2	49.2	30	8380	29	—	—	—	—	—	—	132	160	180	20700	25900	48300	63600	14400	325			
	3/A 07L2	57.3	26.2	6650	20	—	—	80	90	100	112	132	160	180	21800	27200	50600	66500	15200	325			
	3/A 07L2	68.3	22.0	7940	20	—	—	80	90	100	112	132	160	180	23100	28900	53300	70100	16100	325			
	3/A 07L2	87.7	17.1	10200	20	—	—	80	90	100	112	132	160	180	25100	31400	57500	75600	17500	325			
	3/A 07L2	109	13.8	8860	14.5	—	—	80	90	100	112	132	160	180	26900	33700	61300	80600	18800	325			
	3/A 07L2	130	11.6	11100	15.2	—	—	80	90	100	112	132	160	180	28600	35700	64600	85000	19900	325			
	3/A 07L2	140	10.7	11100	14.1	—	—	80	90	100	112	132	160	180	29300	36700	66200	87000	20400	325			
	3/A 07L2	155	9.7	9000	10.3	—	—	80	90	100	112	132	160	180	30000	37500	67500	88800	21100	325			
	3/A 07L2	180	8.3	10900	10.8	—	—	80	90	100	112	132	160	180	30000	37500	67500	88800	22200	325			
	3/A 07L2	198	7.6	8700	7.8	—	—	80	90	100	112	132	160	180	30000	37500	67500	88800	22900	325			
	3/A 07L2	223	6.7	9000	7.2	63	71	80	90	100	112	132	160	180	30000	37500	67500	88800	23800	325			
	3/A 07L2	241	6.2	9000	6.6	63	71	80	90	100	112	132	160	180	30000	37500	67500	88800	24500	325			
	3/A 07L2	282	5.3	8700	5.5	—	—	80	90	100	112	132	160	180	30000	37500	67500	88800	25800	325			
	3/A 07L2	341	4.4	11500	6.0	63	71	80	90	100	112	132	160	180	30600	38200	68800	90400	27500	325			
	3/A 07L2	405	3.7	9080	4.0	63	71	80	90	100	112	132	160	180	31300	39100	70500	92700	29100	325			
3/A 07L2	439	3.4	9180	3.7	63	71	80	90	100	112	132	160	180	31700	39600	71300	93800	29900	325				

B

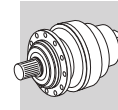

25.7 RATING CHARTS FOR INLINE UNITS 300M L

Reading the rating chart.

313M L		368		60940 Nm											
	i	M _{n2} [Nm]						P ₁	P _{TB}	n ₁	n _{1max}	M _b		M _{2max}	
		n ₂ .h	n ₂ .h	n ₂ .h	n ₂ .h	n ₂ .h	n ₂ .h								[kW]
L2	14.2	48640	48640	48640	48640	35280	28650	150	*	1500	2000	3200	6L	105000	
	16.9	60940	57660	55630	50400	34420	27960	150	*	1500	2000	3200	6L	105000	
	18.5	57130	48690	43150	41430	41090	33380	150	*	1500	2000	3200	6L	105000	
	21.8	60940	57660	55630	50400	33620	27300	150	39	1500	2000	3200	6L	105000	

* BONFIGLIOLI
TECHNICAL SERVICE

Rated hydraulic brake torque lower than applicable torque

1	Reference torque	7	Input angular speed for continuous duty
2	Number of reduction stages (in-line gear unit)	8	Maximum input angular speed for intermittent duty 20% based 60 min running
3	Gear ratio	9	Rated brake torque (Hydraulic brake)
4	Gearbox rated output torque based on: - service factor $f_S=1$ - $n_{2.h}$ indicated	10	Negative multidisc hydraulic brake
5	Maximum power transmitted to input shaft	11	Maximum output torque at gearbox
6	Gearbox thermal capacity	12	Page where dimensions can be sorted from



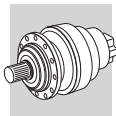



300 L



252

1250 Nm



	i	M _{n2} [Nm]						P ₁	P _{TB}	n ₁	n _{1max}	M _b		M _{2max}	
		n _{2-h} 10000	n _{2-h} 25000	n _{2-h} 50000	n _{2-h} 100000	n _{2-h} 500000	n _{2-h} 1000000								[kW]
L1	3.48	760	730	730	730	730	730	20	*	2000	4000	260	4F	2000	
	4.26	1250	1070	950	860	840	720	20	*	2000	4000	330	4H	2400	
	5.77	860	730	650	650	650	630	20	*	2000	4000	260	4F	2400	
	7.20	700	600	550	550	550	510	16.5	*	2000	4000	160	4D	2400	
	9.00	460	390	370	370	370	370	8.9	*	2000	4000	160	4D	2400	
L2	12.1	760	730	730	730	730	730	11.9	7.6	2000	4000	100	4B	2000	
	14.8	1250	1070	950	860	840	720	12.6	7.7	2000	4000	100	4B	2000	
	18.2	1250	1070	950	860	840	720	10.4	8.4	2000	4000	100	4B	2400	
	20.1	860	730	650	650	650	630	7.2	6.6	2000	4000	100	4B	2000	
	24.6	1250	1070	950	860	840	720	7.8	7.7	2000	4000	100	4B	2400	
	30.7	1250	1070	950	860	840	720	6.4	7.0	2000	4000	50	4A	2400	
	33.3	860	730	650	650	650	630	4.3	6.6	2000	4000	50	4A	2400	
	38.4	1250	1070	950	860	840	720	5.2	6.8	2000	4000	50	4A	2400	
	41.5	860	730	650	650	650	630	3.5	6.1	2000	4000	50	4A	2400	
	51.9	860	730	650	650	650	630	2.9	5.9	2000	4000	50	4A	2400	
	64.8	700	600	550	550	550	510	2.0	5.2	2000	4000	50	4A	2400	
	L3	51.6	1250	1070	950	860	840	720	4.2	5.6	2000	4000	50	4A	2000
		63.2	1250	1070	950	860	840	720	3.5	5.9	2000	4000	50	4A	2400
69.9		860	730	650	650	650	630	2.4	4.9	2000	4000	50	4A	2000	
77.5		1250	1070	950	860	840	720	3.0	5.9	2000	4000	50	4A	2400	
85.6		1250	1070	950	860	840	720	2.7	5.7	2000	4000	50	4A	2400	
105		1250	1070	950	860	840	720	2.2	5.6	2000	4000	50	4A	2400	
116		860	730	650	650	650	630	1.6	5.0	2000	4000	50	4A	2400	
131		1250	1070	950	860	840	720	1.8	5.3	2000	4000	50	4A	2400	
142		1250	1070	950	860	840	720	1.6	5.1	2000	4000	50	4A	2400	
177		1250	1070	950	860	840	720	1.3	4.8	2000	4000	50	4A	2400	
192		860	730	650	650	650	630	1.0	4.6	2000	4000	50	4A	2400	
221		1250	1070	950	860	840	720	1.0	4.4	2000	4000	50	4A	2400	
240		860	730	650	650	650	630	0.82	4.4	2000	4000	50	4A	2400	
299		860	730	650	650	650	630	0.66	4.1	2000	4000	50	4A	2400	
374		860	730	650	650	650	630	0.53	4.0	2000	4000	50	4A	2400	
L4	330	1250	1070	950	860	840	720	0.72	4.2	2000	4000	50	4A	2400	
	403	860	730	650	650	650	630	0.50	3.8	2000	4000	50	4A	2400	
	447	1250	1070	950	860	840	720	0.53	4.1	2000	4000	50	4A	2400	
	494	1250	1070	950	860	840	720	0.48	3.8	2000	4000	50	4A	2400	
	558	1250	1070	950	860	840	720	0.42	3.9	2000	4000	50	4A	2400	
	616	1250	1070	950	860	840	720	0.38	3.6	2000	4000	50	4A	2400	
	755	1250	1070	950	860	840	720	0.31	3.6	2000	4000	50	4A	2400	
	819	1250	1070	950	860	840	720	0.29	3.5	2000	4000	50	4A	2400	
	942	1250	1070	950	860	840	720	0.25	3.4	2000	4000	50	4A	2400	
	1022	1250	1070	950	860	840	720	0.23	3.4	2000	4000	50	4A	2400	
	1108	860	730	650	650	650	630	0.18	3.3	2000	4000	50	4A	2400	
	1275	1250	1070	950	860	840	720	0.19	3.2	2000	4000	50	4A	2400	
	1383	860	730	650	650	650	630	0.15	3.2	2000	4000	50	4A	2400	
	1591	1250	1070	950	860	840	720	0.15	3.1	2000	4000	50	4A	2400	
	1725	860	730	650	650	650	630	0.12	3.1	2000	4000	50	4A	2400	
2153	860	730	650	650	650	630	0.09	3.0	2000	4000	50	4A	2400		
2692	1000	1000	890	850	760	630	0.09	2.9	2000	4000	50	4A	2400		

301 L



262

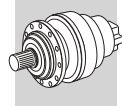

2460 Nm

	i	M _{n2} [Nm]						P ₁	P _{TB}	n ₁	n _{1max}	M _b		M _{2max}
		n _{2-h} 10000	n _{2-h} 25000	n _{2-h} 50000	n _{2-h} 100000	n _{2-h} 500000	n _{2-h} 1000000							
L1	3.48	1490	1430	1430	1430	1430	1300	30	*	2000	4000	440	4L	3400
	4.26	2460	2140	1890	1730	1580	1280	30	*	2000	4000	440	4L	3400
	5.77	1720	1460	1300	1300	1300	1240	30	*	2000	4000	400	4K	3400
	7.20	1150	1150	1150	1150	1150	940	30	*	2000	4000	260	4F	3400





301 L  262

2460 Nm

	i	M _{n2} [Nm]						P ₁	P _{TB}	n ₁	n _{1max}	M _b		M _{2max}	
		n _{2-h} 10000	n _{2-h} 25000	n _{2-h} 50000	n _{2-h} 100000	n _{2-h} 500000	n _{2-h} 1000000								[kW]
L1	9.00	920	780	730	730	730	730	15.8	*	2000	4000	260	4F	3400	
L2	12.1	1490	1430	1430	1430	1430	1300	23.9	9.0	2000	4000	160	4D	3400	
	14.8	2460	2140	1890	1730	1580	1280	25.0	9.4	2000	4000	160	4D	3400	
	18.2	2460	2140	1890	1730	1580	1280	20.7	10.2	2000	4000	160	4D	3400	
	20.1	1720	1460	1300	1300	1300	1240	14.4	8.1	2000	4000	160	4D	3400	
	24.6	2460	2140	1890	1730	1580	1280	15.6	9.2	2000	4000	160	4D	3400	
	30.7	2000	2000	1830	1730	1580	1280	12.6	8.3	2000	4000	100	4B	3400	
	33.3	1720	1460	1300	1300	1300	1240	8.7	7.9	2000	4000	100	4B	3400	
	38.4	1600	1570	1570	1570	1530	1280	10.1	8.0	2000	4000	100	4B	3400	
	41.5	1720	1460	1300	1300	1300	1240	7.0	7.3	2000	4000	100	4B	3400	
	51.9	1720	1460	1300	1300	1300	1240	5.9	7.0	2000	4000	50	4A	3400	
	64.8	1150	1150	1150	1150	1150	940	4.0	6.3	2000	4000	50	4A	3400	
	L3	51.6	2460	2140	1890	1730	1580	1280	8.3	5.8	2000	4000	50	4A	3400
		63.2	2460	2140	1890	1730	1580	1280	7.0	6.2	2000	4000	50	4A	3400
69.9		1720	1460	1300	1300	1300	1240	4.7	5.2	2000	4000	50	4A	3400	
77.5		2460	2140	1890	1730	1580	1280	5.9	6.2	2000	4000	50	4A	3400	
85.6		2460	2140	1890	1730	1580	1280	5.4	5.9	2000	4000	50	4A	3400	
105		2460	2140	1890	1730	1580	1280	4.4	5.9	2000	4000	50	4A	3400	
116		1720	1460	1300	1300	1300	1240	3.1	5.3	2000	4000	50	4A	3400	
131		2460	2140	1890	1730	1580	1280	3.5	5.5	2000	4000	50	4A	3400	
142		2460	2140	1890	1730	1580	1280	3.2	5.3	2000	4000	50	4A	3400	
177		2460	2140	1890	1730	1580	1280	2.6	5.0	2000	4000	50	4A	3400	
192		1720	1460	1300	1300	1300	1240	2.0	4.8	2000	4000	50	4A	3400	
221		2000	2000	1830	1730	1580	1280	2.1	4.6	2000	4000	50	4A	3400	
240		1720	1460	1300	1300	1300	1240	1.6	4.5	2000	4000	50	4A	3400	
299		1720	1460	1300	1300	1300	1240	1.3	4.2	2000	4000	50	4A	3400	
374		1720	1460	1300	1300	1300	1240	1.0	4.1	2000	4000	50	4A	3400	
L4	330	2460	2140	1890	1730	1580	1280	1.4	4.1	2000	4000	50	4A	3400	
	403	1720	1460	1300	1300	1300	1240	1.00	3.7	2000	4000	50	4A	3400	
	447	2460	2140	1890	1730	1580	1280	1.06	4.0	2000	4000	50	4A	3400	
	494	2460	2140	1890	1730	1580	1280	0.96	3.7	2000	4000	50	4A	3400	
	558	2460	2140	1890	1730	1580	1280	0.85	3.8	2000	4000	50	4A	3400	
	616	2460	2140	1890	1730	1580	1280	0.77	3.5	2000	4000	50	4A	3400	
	755	2460	2140	1890	1730	1580	1280	0.63	3.4	2000	4000	50	4A	3400	
	819	2460	2140	1890	1730	1580	1280	0.58	3.4	2000	4000	50	4A	3400	
	942	2460	2140	1890	1730	1580	1280	0.50	3.3	2000	4000	50	4A	3400	
	1022	2460	2140	1890	1730	1580	1280	0.46	3.2	2000	4000	50	4A	3400	
	1108	1720	1460	1300	1300	1300	1240	0.36	3.2	2000	4000	50	4A	3400	
	1275	2460	2140	1890	1730	1580	1280	0.37	3.1	2000	4000	50	4A	3400	
	1383	1720	1460	1300	1300	1300	1240	0.29	3.1	2000	4000	50	4A	3400	
	1591	2000	2000	1830	1730	1580	1280	0.30	3.0	2000	4000	50	4A	3400	
	1725	1720	1460	1300	1300	1300	1240	0.23	2.9	2000	4000	50	4A	3400	
2153	1720	1460	1300	1300	1300	1240	0.19	2.9	2000	4000	50	4A	3400		
2692	1720	1460	1300	1300	1300	1240	0.15	2.8	2000	4000	50	4A	3400		

303 L  272

2970 Nm

	i	M _{n2} [Nm]						P ₁	P _{TB}	n ₁	n _{1max}	M _b		M _{2max}
		n _{2-h} 10000	n _{2-h} 25000	n _{2-h} 50000	n _{2-h} 100000	n _{2-h} 500000	n _{2-h} 1000000							
L1	3.60	2410	2310	2310	2310	2310	2120	40	*	1800	3800	800	5G	5200
	4.25	2970	2810	2810	2650	2570	2090	40	*	1800	3800	800	5G	5200
	5.33	2850	2520	2230	2200	2140	2030	40	*	1800	3800	630	5E	5200
	6.20	2440	2080	1840	1820	1820	1820	40	*	1800	3800	500	5C	5200
	7.50	2000	1750	1650	1650	1650	1500	40	*	1800	3800	400	5B	5200
	9.67	1050	900	860	860	860	860	17.3	*	1800	3800	400	5B	5200
L2	12.5	2410	2310	2310	2310	2130	1730	20	12.7	2000	4000	260	4F	5200



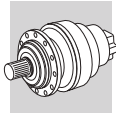



303 L



272

2970 Nm



	i	M _{n2} [Nm]						P ₁	P _{TB}	n ₁	n _{1max}	M _b		M _{2max}	
		n _{2-h} 10000	n _{2-h} 25000	n _{2-h} 50000	n _{2-h} 100000	n _{2-h} 500000	n _{2-h} 1000000								[kW]
L2	15.3	2410	2310	2310	2310	2100	1700	20	13.5	2000	4000	260	4F	5200	
	18.1	2970	2810	2810	2650	2350	1910	20	13.7	2000	4000	260	4F	5200	
	20.8	2410	2210	2210	2210	2030	1650	20	12.0	2000	4000	160	4D	5200	
	22.7	2850	2520	2230	2200	2140	2030	20	12.5	2000	4000	160	4D	5200	
	24.5	2770	2700	2650	2620	2280	1850	20	12.1	2000	4000	160	4D	5200	
	26.4	2440	2080	1840	1820	1820	1820	1820	15.2	11.2	2000	4000	160	4D	5200
	30.8	2850	2520	2230	2200	2140	2030	2030	15.9	11.2	2000	4000	160	4D	5200
	35.8	2440	2080	1840	1820	1820	1820	1820	11.2	10.1	2000	4000	100	4B	5200
	38.4	2850	2450	2230	2200	2140	2030	2030	12.8	10.0	2000	4000	100	4B	5200
	44.6	2440	2080	1840	1820	1820	1820	1820	9.2	9.2	2000	4000	100	4B	5200
	55.8	2300	2080	1840	1820	1820	1820	1820	7.6	8.7	2000	4000	100	4B	5200
	L3	53.4	2410	2310	2310	2310	2100	1700	9.3	8.2	2000	4000	100	4B	5200
63.1		2970	2810	2810	2650	2390	1940	9.8	8.6	2000	4000	100	4B	5200	
72.3		2410	2310	2310	2310	2130	1730	7.0	8.0	2000	4000	50	4A	5200	
77.2		2970	2810	2810	2650	2350	1910	8.2	8.6	2000	4000	50	4A	5200	
90.2		2410	2310	2310	2310	2130	1730	5.6	7.4	2000	4000	50	4A	5200	
105		2970	2810	2810	2650	2350	1910	6.2	8.0	2000	4000	50	4A	5200	
113		2440	2080	1840	1820	1820	1820	1820	4.4	7.4	2000	4000	50	4A	5200
124		2440	2080	1840	1820	1820	1820	1820	4.0	7.0	2000	4000	50	4A	5200
141		2770	2700	2650	2620	2280	1850	1850	4.4	7.1	2000	4000	50	4A	5200
152		2440	2080	1840	1820	1820	1820	1820	3.4	7.0	2000	4000	50	4A	5200
164		2850	2520	2230	2200	2140	2030	2030	3.9	7.0	2000	4000	50	4A	5200
178		2850	2520	2230	2200	2140	2030	2030	3.6	6.7	2000	4000	50	4A	5200
190		2440	2080	1840	1820	1820	1820	1820	2.8	6.6	2000	4000	50	4A	5200
220		2250	2200	2250	2250	1830	1800	1800	2.3	6.0	2000	4000	50	4A	5200
258		2440	2080	1840	1820	1820	1820	1820	2.0	5.9	2000	4000	50	4A	5200
276		2850	2450	2230	2200	2140	2030	2030	2.4	5.8	2000	4000	50	4A	5200
321		2440	2080	1840	1820	1820	1820	1820	1.6	5.4	2000	4000	50	4A	5200
389		2000	1750	1650	1650	1650	1500	1500	1.2	5.2	2000	4000	50	4A	5200
402	2440	2080	1840	1820	1820	1820	1820	1.3	5.3	2000	4000	50	4A	5200	
L4	413	2850	2520	2230	2200	2140	2030	1.6	5.8	2000	4000	50	4A	5200	
	446	2970	2810	2810	2650	2350	1910	1.5	5.8	2000	4000	50	4A	5200	
	492	2770	2700	2650	2620	2280	1850	1.3	5.4	2000	4000	50	4A	5200	
	556	2970	2810	2810	2650	2350	1910	1.2	5.5	2000	4000	50	4A	5200	
	649	2410	2310	2310	2310	2130	1730	0.84	4.7	2000	4000	50	4A	5200	
	718	2440	2080	1840	1820	1820	1820	0.76	4.9	2000	4000	50	4A	5200	
	816	2770	2700	2650	2620	2280	1850	0.80	4.9	2000	4000	50	4A	5200	
	896	2440	2080	1840	1820	1820	1820	0.61	4.7	2000	4000	50	4A	5200	
	1018	2770	2700	2650	2620	2280	1850	0.64	4.7	2000	4000	50	4A	5200	
	1098	2440	2080	1840	1820	1820	1820	0.50	4.6	2000	4000	50	4A	5200	
	1278	2850	2520	2230	2200	2140	2030	0.53	4.5	2000	4000	50	4A	5200	
	1370	2440	2080	1840	1820	1820	1820	0.40	4.4	2000	4000	50	4A	5200	
	1586	2250	2250	2250	2250	1830	1800	1800	0.34	4.2	2000	4000	50	4A	5200
	1854	2440	2080	1840	1820	1820	1820	1820	0.29	4.2	2000	4000	50	4A	5200
	1991	2850	2450	2230	2200	2140	2030	2030	0.34	4.1	2000	4000	50	4A	5200
2243	2000	1750	1650	1650	1650	1500	1500	0.21	4.1	2000	4000	50	4A	5200	
2799	2000	1750	1650	1650	1650	1500	1500	0.17	4.0	2000	4000	50	4A	5200	

304 L



284

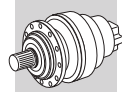

3960 Nm

	i	M _{n2} [Nm]						P ₁	P _{TB}	n ₁	n _{1max}	M _b		M _{2max}
		n _{2-h} 10000	n _{2-h} 25000	n _{2-h} 50000	n _{2-h} 100000	n _{2-h} 500000	n _{2-h} 1000000							
L1	3.60	3710	3520	3500	3440	3120	2830	50	*	1800	3800	800	5G	7300
	4.25	3960	3750	3690	3540	3430	2780	50	*	1800	3800	800	5G	7300
	5.33	3740	3190	2850	2850	2850	2710	50	*	1800	3800	630	5E	7300
	6.57	3000	2560	2390	2390	2390	2390	50	*	1800	3800	500	5C	7300
L2	12.5	3710	3520	3500	3440	3120	2830	30	12.9	2000	4000	260	4F	7300





304 L  284

3960 Nm

	i	M _{n2} [Nm]						P ₁	P _{TB}	n ₁	n _{1max}	M _b		M _{2max}
		n _{2-h} 10000	n _{2-h} 25000	n _{2-h} 50000	n _{2-h} 100000	n _{2-h} 500000	n _{2-h} 1000000							
L2	15.3	3710	3520	3500	3440	3120	2830	30	13.9	2000	4000	260	4F	7300
	18.1	3960	3750	3690	3540	3430	2780	30	14.2	2000	4000	260	4F	7300
	20.8	3710	3520	3500	3440	3120	2830	30	12.4	2000	4000	160	4D	7300
	22.7	3740	3190	2850	2850	2850	2710	28	13.0	2000	4000	160	4D	7300
	24.5	3960	3750	3690	3540	3430	2780	30	12.5	2000	4000	160	4D	7300
	30.8	3740	3190	2850	2850	2850	2710	20	11.6	2000	4000	160	4D	7300
	38.4	3740	3190	2850	2850	2850	2710	16.2	10.4	2000	4000	160	4D	7300
	47.3	3000	2560	2390	2390	2390	2390	10.9	9.0	2000	4000	100	4B	7300
	59.1	3000	2560	2390	2390	2390	2390	8.9	8.7	2000	4000	100	4B	7300
L3	43.6	3710	3520	3500	3440	3120	2830	18.4	8.5	2000	4000	50	4A	7300
	53.4	3710	3520	3500	3440	3120	2830	15.1	8.6	2000	4000	50	4A	7300
	63.1	3960	3750	3690	3540	3430	2780	13.4	8.7	2000	4000	50	4A	7300
	72.3	3710	3520	3500	3440	3120	2830	11.2	7.8	2000	4000	50	4A	7300
	77.2	3960	3750	3690	3540	3430	2780	11.0	9.1	2000	4000	50	4A	7300
	90.2	3710	3520	3500	3440	3080	2830	9.0	7.1	2000	4000	50	4A	7300
	105	3960	3750	3690	3540	3430	2780	8.4	8.5	2000	4000	50	4A	7300
	111	3710	3520	3500	3440	3120	2830	7.5	7.8	2000	4000	50	4A	7300
	130	3960	3750	3690	3540	3430	2780	6.8	7.9	2000	4000	50	4A	7300
	141	3960	3750	3690	3540	3430	2780	6.3	7.5	2000	4000	50	4A	7300
	150	3710	3520	3500	3440	3120	2830	5.6	7.0	2000	4000	50	4A	7300
	165	3000	2560	2390	2390	2390	2390	3.8	6.7	2000	4000	50	4A	7300
	178	3740	3190	2850	2850	2850	2710	4.5	7.1	2000	4000	50	4A	7300
	202	3000	2560	2390	2390	2390	2390	3.1	6.6	2000	4000	50	4A	7300
	220	3960	3710	3660	3540	3430	2780	4.1	6.4	2000	4000	50	4A	7300
	273	3000	2560	2390	2390	2390	2390	2.3	6.0	2000	4000	50	4A	7300
	341	3000	2560	2390	2390	2390	2390	1.8	5.8	2000	4000	50	4A	7300
	426	3000	2560	2390	2390	2390	2390	1.5	5.4	2000	4000	50	4A	7300
L4	413	3740	3190	2850	2850	2850	2710	2.0	6.2	2000	4000	50	4A	7300
	446	3960	3750	3690	3540	3430	2780	2.1	5.9	2000	4000	50	4A	7300
	492	3960	3750	3690	3540	3430	2780	1.9	5.3	2000	4000	50	4A	7300
	556	3960	3750	3690	3540	3430	2780	1.7	5.8	2000	4000	50	4A	7300
	649	3710	3520	3500	3440	3120	2830	1.4	4.9	2000	4000	50	4A	7300
	702	3000	2560	2390	2390	2390	2390	0.93	5.1	2000	4000	50	4A	7300
	816	3960	3750	3690	3540	3430	2780	1.1	5.1	2000	4000	50	4A	7300
	1018	3960	3750	3690	3540	3430	2780	0.92	4.9	2000	4000	50	4A	7300
	1164	3000	2560	2390	2390	2390	2390	0.56	4.7	2000	4000	50	4A	7300
	1271	3960	3750	3690	3540	3430	2780	0.74	4.6	2000	4000	50	4A	7300
	1344	3710	3520	3500	3440	3080	2830	0.65	4.3	2000	4000	50	4A	7300
	1586	3960	3710	3660	3540	3430	2780	0.59	4.4	2000	4000	50	4A	7300
	1815	3000	2560	2390	2390	2390	2390	0.36	4.4	2000	4000	50	4A	7300
	1991	3740	3190	2850	2850	2850	2710	0.42	4.2	2000	4000	50	4A	7300
	2269	3000	2560	2390	2390	2390	2390	0.29	4.3	2000	4000	50	4A	7300
2453	3000	2560	2390	2390	2390	2390	0.27	4.0	2000	4000	50	4A	7300	

305 L  296

5800 Nm

	i	M _{n2} [Nm]						P ₁	P _{TB}	n ₁	n _{1max}	M _b		M _{2max}
		n _{2-h} 10000	n _{2-h} 25000	n _{2-h} 50000	n _{2-h} 100000	n _{2-h} 500000	n _{2-h} 1000000							
L1	3.60	4700	4490	4490	4490	4480	3640	60	*	1800	3800	1000	5K	8800
	4.25	5800	5500	5480	5300	4410	3580	60	*	1800	3800	1000	5K	8800
	5.33	5600	5040	4470	4400	4280	3490	60	*	1800	3800	1000	5K	8800
	6.20	4690	4000	3600	3600	3550	3460	60	*	1800	3800	800	5G	8800
	7.50	3800	3300	3100	3100	3000	2790	60	*	1800	3800	630	5E	8800
L2	12.5	4700	4490	4490	4490	3800	3090	30	13.3	2000	4000	400	4K	8800
	15.3	4700	4490	4490	4490	3750	3040	30	14.3	2000	4000	330	4H	8800
	18.1	5800	5500	5480	5300	4210	3420	30	14.9	2000	4000	400	4K	8800
	20.8	4700	4450	4430	4430	3630	2950	30	12.9	2000	4000	260	4F	8800



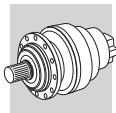



305 L



296

5800 Nm



	i	M _{n2} [Nm]						P ₁	P _{TB}	n ₁	n _{1max}	M _b		M _{2max}
		n _{2-h} 10000	n _{2-h} 25000	n _{2-h} 50000	n _{2-h} 100000	n _{2-h} 500000	n _{2-h} 1000000							
L2	22.7	5600	5040	4470	4400	4280	3490	30	13.9	2000	4000	330	4H	8800
	24.5	5530	5400	5300	5230	4070	3310	30	13.3	2000	4000	330	4H	8800
	26.4	4690	4000	3600	3600	3550	3460	30	12.5	2000	4000	260	4F	8800
	30.8	5600	5040	4470	4400	4280	3490	30	12.3	2000	4000	260	4F	8800
	35.8	4690	4000	3600	3600	3550	3460	22.4	11.2	2000	4000	160	4D	8800
	38.4	5600	4900	4470	4400	4280	3490	25.5	11.0	2000	4000	160	4D	8800
	44.6	4690	4000	3600	3600	3550	3460	18.3	10.1	2000	4000	160	4D	8800
	55.8	4430	4000	3600	3600	3500	3460	15.2	9.7	2000	4000	160	4D	8800
L3	53.4	4700	4490	4490	4490	3750	3040	18.8	9.1	2000	4000	100	4B	8800
	63.1	5800	5480	5480	5300	4270	3470	19.4	9.5	2000	4000	160	4D	8800
	72.3	4700	4490	4490	4490	3800	3090	14.1	8.8	2000	4000	100	4B	8800
	77.2	5800	5500	5480	5300	4210	3420	16.3	9.6	2000	4000	100	4B	8800
	90.2	4700	4490	4490	4490	3800	3090	11.4	8.2	2000	4000	100	4B	8800
	105	5800	5500	5480	5300	4210	3420	12.3	8.9	2000	4000	100	4B	8800
	113	4690	4000	3600	3600	3550	3460	8.7	8.4	2000	4000	100	4B	8800
	124	4690	4000	3600	3600	3550	3460	8.0	7.8	2000	4000	50	4A	8800
	141	5530	5350	5300	5230	4070	3310	8.9	7.9	2000	4000	100	4B	8800
	152	4690	4000	3600	3600	3550	3460	6.7	7.8	2000	4000	50	4A	8800
	164	5600	5040	4470	4400	4280	3490	7.7	7.8	2000	4000	50	4A	8800
	178	5600	5040	4470	4400	4280	3490	7.2	7.5	2000	4000	50	4A	8800
	190	4690	4000	3600	3600	3550	3460	5.5	7.3	2000	4000	50	4A	8800
	220	4750	4750	4750	4750	3660	3210	4.9	6.7	2000	4000	50	4A	8800
	258	4690	4000	3600	3600	3550	3460	4.1	6.6	2000	4000	50	4A	8800
	276	5600	4900	4470	4400	4280	3490	4.6	6.4	2000	4000	50	4A	8800
	321	4690	4000	3600	3600	3550	3460	3.3	6.1	2000	4000	50	4A	8800
	389	3800	3300	3100	3100	3000	2790	2.2	5.8	2000	4000	50	4A	8800
402	4690	4000	3600	3600	3550	3460	2.6	5.9	2000	4000	50	4A	8800	
L4	413	5600	5040	4470	4400	4280	3490	3.2	6.4	2000	4000	50	4A	8800
	446	5800	5500	5480	5300	4210	3420	3.1	6.4	2000	4000	50	4A	8800
	492	5530	5350	5300	5230	4070	3310	2.6	5.9	2000	4000	50	4A	8800
	556	5800	5500	5480	5300	4210	3420	2.5	6.0	2000	4000	50	4A	8800
	649	4700	4490	4490	4490	3800	3090	1.7	5.1	2000	4000	50	4A	8800
	718	4690	4000	3600	3600	3550	3460	1.5	5.3	2000	4000	50	4A	8800
	816	5530	5350	5300	5230	4070	3310	1.6	5.3	2000	4000	50	4A	8800
	896	4690	4000	3600	3600	3550	3460	1.2	5.1	2000	4000	50	4A	8800
	1018	5530	5350	5300	5230	4070	3310	1.3	5.1	2000	4000	50	4A	8800
	1098	4690	4000	3600	3600	3550	3460	0.99	4.9	2000	4000	50	4A	8800
	1278	5600	5040	4470	4400	4280	3490	1.0	4.9	2000	4000	50	4A	8800
	1370	4690	4000	3600	3600	3550	3460	0.79	4.7	2000	4000	50	4A	8800
	1586	4750	4750	4750	4750	3660	3210	0.71	4.5	2000	4000	50	4A	8800
	1854	4690	4000	3600	3600	3550	3460	0.59	4.4	2000	4000	50	4A	8800
	1991	5600	4900	4470	4400	4280	3490	0.67	4.3	2000	4000	50	4A	8800
2243	3800	3300	3100	3100	3000	2790	0.40	4.3	2000	4000	50	4A	8800	
2799	3800	3300	3100	3100	3000	2790	0.32	4.1	2000	4000	50	4A	8800	

306 L



308

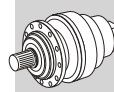

10840 Nm

	i	M _{n2} [Nm]						P ₁	P _{TB}	n ₁	n _{1max}	M _b		M _{2max}
		n _{2-h} 10000	n _{2-h} 25000	n _{2-h} 50000	n _{2-h} 100000	n _{2-h} 500000	n _{2-h} 1000000							
L1	3.60	10840	10380	10380	10380	7100	5770	75	*	1600	3000	2750	6K	14900
	4.25	10420	9850	9850	9600	6990	5680	75	*	1600	3000	2750	6K	14900
	5.33	10080	9350	8300	7950	6810	5530	75	*	1600	3000	2200	6G	14900
	6.20	8630	7370	6530	6500	6460	5480	75	*	1600	3000	1600	6E	14900
	7.50	7000	5900	5500	5500	5040	5040	75	*	1600	3000	1200	6C	14900
L2	13.0	8020	8020	8020	8020	6210	5040	40	21.2	1800	3800	800	5G	14900
	15.3	9770	9340	9340	9300	6110	4960	40	22.8	1800	3800	800	5G	14900
	18.1	10420	9850	9850	9600	6860	5570	40	23.7	1800	3800	630	5E	14900





306 L  308

10840 Nm

	i	M _{n2} [Nm]						P ₁	P _{TB}	n ₁	n _{1max}	M _b		M _{2max}
		n _{2-h} 10000	n _{2-h} 25000	n _{2-h} 50000	n _{2-h} 100000	n _{2-h} 500000	n _{2-h} 1000000							
L2	22.7	9560	9100	9100	9100	6680	5430	40	22.5	1800	3800	500	5C	14900
	26.4	7890	7590	7590	7590	6620	5380	40	20.4	1800	3800	400	5B	14900
	28.4	10080	9350	8300	7950	6810	5530	40	20.2	1800	3800	400	5B	14900
	33.1	9540	9350	8300	7950	6810	5530	40	18.5	1800	3800	400	5B	14900
	38.4	8630	7370	6530	6500	6460	5480	34	16.6	1800	3800	400	5B	14900
	46.5	8500	7370	6530	6500	6460	5480	29	15.5	1800	3800	400	5B	14900
	56.3	7000	5900	5500	5500	5040	5040	21	14.5	1800	3800	400	5B	14900
	72.5	6400	5900	5500	5500	5040	5040	16.3	12.6	1800	3800	400	5B	14900
L3	53.2	9770	9340	9340	9300	6110	4960	20	13.0	2000	4000	260	4F	14900
	65.2	9770	9340	9340	9300	6110	4960	20	13.4	2000	4000	160	4D	14900
	77.0	10420	9850	9850	9600	6860	5570	20	13.6	2000	4000	160	4D	14900
	81.9	8320	7700	7700	7530	5950	4830	20	12.5	2000	4000	160	4D	14900
	88.3	9450	9450	9450	9450	6970	5660	20	12.3	2000	4000	160	4D	14900
	104	10420	9850	9850	9600	6860	5570	20	12.3	2000	4000	160	4D	14900
	112	7890	7590	7590	7590	6620	5380	15.2	11.6	2000	4000	160	4D	14900
	121	10080	9350	8300	7950	6810	5530	17.2	11.7	2000	4000	100	4B	14900
	141	9540	9350	8300	7950	6810	5530	14.8	10.9	2000	4000	100	4B	14900
	152	7890	7590	7590	7590	6620	5380	11.3	10.6	2000	4000	100	4B	14900
	190	8630	7370	6530	6500	6460	5480	10.2	9.8	2000	4000	100	4B	14900
	205	10080	9350	8300	7950	6810	5530	10.6	9.9	2000	4000	100	4B	14900
	222	8630	7370	6530	6500	6460	5480	8.8	9.4	2000	4000	50	4A	14900
	238	9540	9350	8300	7950	6810	5530	9.0	9.3	2000	4000	50	4A	14900
	268	7000	5900	5500	5500	5040	5040	6.0	8.9	2000	4000	50	4A	14900
	288	7000	5900	5500	5500	5040	5040	5.6	8.9	2000	4000	50	4A	14900
325	7000	5900	5500	5500	5040	5040	4.9	8.4	2000	4000	50	4A	14900	
405	7000	5900	5500	5500	5040	5040	4.0	7.9	2000	4000	50	4A	14900	
L4	391	8630	7370	6530	6500	6460	5480	5.1	8.0	2000	4000	50	4A	14900
	444	10420	9850	9850	9600	6860	5570	5.3	8.1	2000	4000	50	4A	14900
	509	9450	9450	9450	9450	6970	5660	4.1	7.7	2000	4000	50	4A	14900
	589	10080	9350	8300	7950	6810	5530	3.8	7.6	2000	4000	50	4A	14900
	636	9450	9450	9450	9450	6970	5660	3.3	7.2	2000	4000	50	4A	14900
	700	10080	9350	8300	7950	6810	5530	3.2	7.6	2000	4000	50	4A	14900
	809	7890	7590	7590	7590	6620	5380	2.2	7.1	2000	4000	50	4A	14900
	877	7890	7590	7590	7590	6620	5380	2.0	6.9	2000	4000	50	4A	14900
	1015	9540	9350	8300	7950	6810	5530	2.2	6.8	2000	4000	50	4A	14900
	1095	7890	7590	7590	7590	6620	5380	1.6	6.5	2000	4000	50	4A	14900
	1279	8630	7370	6530	6500	6460	5480	1.6	6.3	2000	4000	50	4A	14900
	1475	10080	9350	8300	7950	6810	5530	1.5	6.1	2000	4000	50	4A	14900
	1597	8630	7370	6530	6500	6460	5480	1.3	5.9	2000	4000	50	4A	14900
	1843	10080	9350	8300	7950	6810	5530	1.2	5.9	2000	4000	50	4A	14900
	2074	7000	5900	5500	5500	5040	5040	0.80	5.7	2000	4000	50	4A	14900
	2337	7000	5900	5500	5500	5040	5040	0.71	5.6	2000	4000	50	4A	14900
2916	7000	5900	5500	5500	5040	5040	0.57	5.2	2000	4000	50	4A	14900	

307 L  320

15680 Nm

	i	M _{n2} [Nm]						P ₁	P _{TB}	n ₁	n _{1max}	M _b		M _{2max}
		n _{2-h} 10000	n _{2-h} 25000	n _{2-h} 50000	n _{2-h} 100000	n _{2-h} 500000	n _{2-h} 1000000							
L1	3.43	9000	9000	9000	9000	8300	7960	115	*	1500	2500	3300	6L	18600
	4.09	15680	14890	14890	13510	9560	7770	115	*	1500	2500	3300	6L	21000
	5.25	14840	12700	11300	10790	9340	7590	115	*	1500	2500	3300	6L	21000
	6.23	11000	9600	8700	8700	8240	7490	115	*	1500	2500	2200	6G	21000
L2	12.3	9000	9000	9000	9000	8300	7960	60	17.7	1800	3800	1000	5K	18600
	14.7	15680	14890	14890	13510	9560	7770	60	17.0	1800	3800	800	5G	21000
	17.4	15680	14890	14890	13510	9560	7770	60	21.2	1800	3800	1000	5K	21000
	21.8	15680	14890	14890	13510	9560	7770	60	21.8	1800	3800	800	5G	21000
	25.4	14670	14010	14010	13510	9560	7770	60	20.6	1800	3800	630	5E	21000



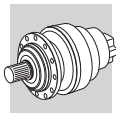

307 L



320

15680 Nm

	i	M _{n2} [Nm]						P ₁	P _{TB}	n ₁	n _{1max}	M _b		M _{2max}
		n _{2-h} 10000	n _{2-h} 25000	n _{2-h} 50000	n _{2-h} 100000	n _{2-h} 500000	n _{2-h} 1000000							
L2	28.0	14840	12700	11300	10790	9340	7590	60	21.2	1800	3800	500	5C	21000
	30.7	12300	12300	12300	12300	9560	7770	60	19.5	1800	3800	500	5C	21000
	32.6	14840	12700	11300	10790	9340	7590	60	19.9	1800	3800	500	5C	21000
	38.6	11000	9600	8700	8700	8240	7490	46	18.0	1800	3800	400	5B	21000
	46.7	11000	9600	8700	8700	8240	7490	39	17.0	1800	3800	400	5B	21000
L3	51.3	15680	14890	14890	13510	9560	7770	30	14.4	2000	4000	330	4H	21000
	60.5	15680	14890	14890	13510	9560	7770	30	14.5	2000	4000	330	4H	21000
	74.1	15680	14890	14890	13510	9560	7770	30	15.1	2000	4000	260	4F	21000
	80.6	14840	12700	11300	10790	9340	7590	30	14.3	2000	4000	260	4F	21000
	93.0	15680	14890	14890	13510	9560	7770	30	14.2	2000	4000	260	4F	21000
	100	15680	14890	14890	13510	9560	7770	30	13.8	2000	4000	260	4F	21000
	113	14840	12700	11300	10790	9340	7590	26	12.5	2000	4000	160	4D	21000
	126	15680	14890	14890	13510	9560	7770	26	13.0	2000	4000	160	4D	21000
	139	14840	12700	11300	10790	9340	7590	22	12.8	2000	4000	160	4D	21000
	146	15000	14010	14010	13510	9560	7770	23	12.1	2000	4000	160	4D	21000
	162	14840	12700	11300	10790	9340	7590	19.4	12.5	2000	4000	100	4B	21000
	177	12300	12300	12300	12300	9560	7770	15.9	11.3	2000	4000	100	4B	21000
	202	14840	12700	11300	10790	9340	7590	15.9	11.5	2000	4000	100	4B	21000
	221	15000	13800	12900	12500	9560	7770	15.6	10.5	2000	4000	100	4B	21000
	239	11000	9600	8700	8700	8240	7490	10.5	10.8	2000	4000	50	4A	21000
	284	14330	12700	11300	10790	9340	7590	11.3	10.2	2000	4000	50	4A	21000
	336	11000	9600	8700	8700	8240	7490	7.5	9.6	2000	4000	50	4A	21000
L4	349	15680	14890	14890	13510	9560	7770	10.2	9.8	2000	4000	50	4A	21000
	406	14840	12700	11300	10790	9340	7590	8.2	10.1	2000	4000	50	4A	21000
	465	14840	12700	11300	10790	9340	7590	7.1	9.4	2000	4000	50	4A	21000
	509	15000	14010	14010	13510	9560	7770	7.0	8.4	2000	4000	50	4A	21000
	579	15680	14890	14890	13510	9560	7770	6.1	8.8	2000	4000	50	4A	21000
	654	14840	12700	11300	10790	9340	7590	5.1	8.6	2000	4000	50	4A	21000
	722	15680	14890	14890	13510	9560	7770	4.9	8.2	2000	4000	50	4A	21000
	801	14840	12700	11300	10790	9340	7590	4.1	8.5	2000	4000	50	4A	21000
	906	15680	14890	14890	13510	9560	7770	3.9	7.9	2000	4000	50	4A	21000
	999	14840	12700	11300	10790	9340	7590	3.3	8.0	2000	4000	50	4A	21000
	1157	14840	12700	11300	10790	9340	7590	2.9	7.5	2000	4000	50	4A	21000
	1274	12300	12300	12300	12300	9560	7770	2.3	7.1	2000	4000	50	4A	21000
	1408	15680	14890	14890	13510	9560	7770	2.5	7.1	2000	4000	50	4A	21000
	1591	15000	13800	12900	12500	9560	7770	2.2	6.6	2000	4000	50	4A	21000
	1767	15680	14890	14890	13510	9560	7770	2.0	6.8	2000	4000	50	4A	21000
	2041	14330	12700	11300	10790	9340	7590	1.6	6.5	2000	4000	50	4A	21000
	2423	11000	9600	8700	8700	8240	7490	1.1	6.2	2000	4000	50	4A	21000

309 L



332

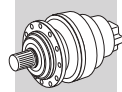

23240 Nm

	i	M _{n2} [Nm]						P ₁	P _{TB}	n ₁	n _{1max}	M _b		M _{2max}
		n _{2-h} 10000	n _{2-h} 25000	n _{2-h} 50000	n _{2-h} 100000	n _{2-h} 500000	n _{2-h} 1000000							
L1	3.43	13000	13000	13000	13000	12310	10920	150	*	1500	2000	3300	6L	27900
	4.09	23240	22070	22070	20260	13120	10660	150	*	1500	2000	3300	6L	29000
	5.25	21980	19060	16940	16190	12810	10410	150	*	1500	2000	3300	6L	29000
	6.23	17000	14400	13000	13000	12370	10280	150	*	1500	2000	3300	6L	29000
L2	12.3	13000	13000	13000	13000	10290	8360	60	25.7	1800	3800	1000	5K	27900
	14.7	17730	17730	17730	17730	11650	9460	60	25.4	1800	3800	1000	5K	29000
	17.4	21620	21260	21260	18580	11460	9310	60	30	1800	3800	1000	5K	29000
	21.8	18510	17500	17500	17140	11160	9070	60	30	1800	3800	1000	5K	29000
	25.4	14670	14300	14300	14300	11060	8990	60	28.4	1800	3800	800	5G	29000
	28.0	21980	19060	16940	16190	12810	10410	60	29.7	1800	3800	800	5G	29000
	32.6	18300	18100	16940	16190	12810	10410	60	27.6	1800	3800	630	5E	29000
	38.6	17000	14400	13000	13000	12370	10280	60	25.1	1800	3800	500	5C	29000
	46.7	17000	14400	13000	13000	12370	10280	58	23.5	1800	3800	400	5B	29000





309 L  332

23240 Nm

	i	M _{n2} [Nm]						P ₁	P _{TB}	n ₁	n _{1max}	M _b		M _{2max}
		n _{2-h} 10000	n _{2-h} 25000	n _{2-h} 50000	n _{2-h} 100000	n _{2-h} 500000	n _{2-h} 1000000							
L3	51.3	17730	17730	17730	17730	11650	9460	30	20.2	2000	4000	400	4K	29000
	60.5	21620	21260	21260	18580	11460	9310	30	20.3	2000	4000	400	4K	29000
	74.1	21620	21260	21260	18580	11460	9310	30	20.7	2000	4000	260	4F	29000
	80.6	21980	19060	16940	16190	12810	10410	30	19.9	2000	4000	260	4F	29000
	93.0	18510	17500	17500	17140	11160	9070	30	19.3	2000	4000	260	4F	29000
	100	21620	21260	21260	18580	11460	9310	30	18.6	2000	4000	260	4F	29000
	113	18300	18100	16940	16190	12810	10410	30	17.1	2000	4000	260	4F	29000
	126	18510	17500	17500	17140	11160	9070	30	17.4	2000	4000	260	4F	29000
	139	18300	18100	16940	16190	12810	10410	30	17.2	2000	4000	160	4D	29000
	162	21980	19060	16940	16190	12810	10410	29	16.9	2000	4000	160	4D	29000
	183	14670	14300	14300	14300	11060	8990	18.2	14.8	2000	4000	100	4B	29000
	202	21980	19060	16940	16190	12810	10410	23.9	15.4	2000	4000	100	4B	29000
	223	17000	14400	13000	13000	12370	10280	17.5	14.7	2000	4000	100	4B	29000
	239	17000	14400	13000	13000	12370	10280	16.3	14.5	2000	4000	100	4B	29000
	284	15800	15800	15800	15000	12810	10410	12.8	13.6	2000	4000	100	4B	29000
	336	17000	14400	13000	13000	12370	10280	11.6	12.8	2000	4000	100	4B	29000
	L4	349	21620	21260	21260	18580	11460	9310	14.4	12.7	2000	4000	100	4B
406		21980	19060	16940	16190	12810	10410	12.3	13.3	2000	4000	50	4A	29000
465		21980	19060	16940	16190	12810	10410	10.7	12.3	2000	4000	50	4A	29000
509		14670	14300	14300	14300	11060	8990	6.7	11.0	2000	4000	50	4A	29000
579		21620	21260	21260	18580	11460	9310	8.7	11.4	2000	4000	50	4A	29000
654		18300	18100	16940	16190	12810	10410	6.6	11.2	2000	4000	50	4A	29000
722		21620	21260	21260	18580	11460	9310	7.0	10.6	2000	4000	50	4A	29000
801		18300	18100	16940	16190	12810	10410	5.4	11.0	2000	4000	50	4A	29000
906		18510	17500	17500	17140	11160	9070	4.7	10.2	2000	4000	50	4A	29000
999		18300	18100	16940	16190	12810	10410	4.3	10.3	2000	4000	50	4A	29000
1149		17000	14400	13000	13000	12370	10280	3.5	9.9	2000	4000	50	4A	29000
1286		17000	14400	13000	13000	12370	10280	3.1	9.6	2000	4000	50	4A	29000
1380		17000	14400	13000	13000	12370	10280	2.9	9.4	2000	4000	50	4A	29000
1605		17000	14400	13000	13000	12370	10280	2.5	9.0	2000	4000	50	4A	29000
1723		17000	14400	13000	13000	12370	10280	2.3	8.9	2000	4000	50	4A	29000
2003		17000	14400	13000	13000	12370	10280	1.9	8.4	2000	4000	50	4A	29000
2423		17000	14400	13000	13000	12370	10280	1.7	8.0	2000	4000	50	4A	29000

310M L  344

33640 Nm

	i	M _{n2} [Nm]						P ₁	P _{TB}	n ₁	n _{1max}	M _b		M _{2max}
		n _{2-h} 10000	n _{2-h} 25000	n _{2-h} 50000	n _{2-h} 100000	n _{2-h} 500000	n _{2-h} 1000000							
L1	4.09	33640	31900	29360	26490	21190	17220	175	*	1750	1800	—	—	47600
	5.25	30110	25640	22700	21660	20710	16820	175	*	1750	1800	—	—	47600
	6.23	23930	20350	18000	17810	17810	16620	175	*	1750	1800	—	—	47600
L2	14.7	33640	31900	29360	26490	18470	15000	75	27.5	1750	3000	2750	6K	47600
	17.4	33640	31900	29360	26490	18180	14770	75	34	1750	3000	2200	6G	47600
	21.8	33170	30650	29360	26490	17700	14380	75	36	1750	3000	2200	6G	47600
	25.4	26060	24860	24860	24860	17540	14250	75	34	1750	3000	1600	6E	47600
	28.0	30110	25640	22700	21660	20710	16820	75	35	1750	3000	1600	6E	47600
	30.7	19480	19330	19330	19330	17120	13900	75	33	1750	3000	1200	6C	47600
	32.6	30110	25640	22700	21660	20710	16820	75	33	1750	3000	1200	6C	47600
	38.6	23930	20350	18000	17810	17810	16620	75	28.8	1750	3000	900	6B	47600
46.7	23930	20350	18000	17810	17810	16620	75	27.8	1750	3000	900	6B	47600	
L3	53.0	30730	30730	29360	26160	16140	13110	40	26.1	1800	3800	630	5E	47600
	62.6	33640	31900	29360	25750	15890	12910	40	26.8	1800	3800	630	5E	47600
	73.9	33640	31900	29360	26490	17850	14500	40	27.2	1800	3800	500	5C	47600
	80.3	30110	25640	22700	21660	18920	15370	40	25.5	1800	3800	400	5B	47600
	92.7	33640	31900	29350	26250	17380	14110	40	25.9	1800	3800	400	5B	47600
	101	30110	25640	22700	21660	18420	14960	40	24.4	1800	3800	400	5B	47600
	108	28060	28060	28060	26500	17220	13990	40	24.1	1800	3800	400	5B	47600



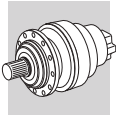



310M L



344

33640 Nm



	i	M _{n2} [Nm]						P ₁	P _{TB}	n ₁	n _{1max}	M _b		M _{2max}
		n _{2-h}	n _{2-h}	n _{2-h}	n _{2-h}	n _{2-h}	n _{2-h}							
L3	119	30110	25640	22700	21660	20710	16820	40	23.8	1800	3800	400	5B	47600
	135	33170	30640	29350	26500	17700	14380	40	22.4	1800	3800	400	5B	47600
	149	30110	25640	22700	21660	20710	16820	40	22.8	1800	3800	400	5B	47600
	164	27150	27150	27150	26490	17700	14380	34	21.0	1800	3800	400	5B	47600
	177	23930	20350	18000	17810	17810	16620	28	20.6	1800	3800	400	5B	47600
	202	30110	25640	22700	21660	20710	16820	31	19.9	1800	3800	400	5B	47600
	230	19480	19330	19330	19330	17120	13900	17.5	18.5	1800	3800	400	5B	47600
	249	23930	20350	18000	17810	17810	16620	20	18.4	1800	3800	400	5B	47600
	295	24820	24820	22700	21660	20380	16550	17.4	17.8	1800	3800	400	5B	47600
	350	23930	20350	18000	17810	17810	16620	14.1	16.4	1800	3800	400	5B	47600
L4	392	23930	20350	18000	17810	17810	16620	14.5	15.4	2000	4000	100	4B	47600
	453	28950	28950	28950	25070	15470	12570	15.1	15.0	2000	4000	100	4B	47600
	507	30110	25640	22700	21660	20710	16820	14.0	15.8	2000	4000	100	4B	47600
	590	30110	25640	22700	21660	20510	16600	12.1	14.8	2000	4000	100	4B	47600
	637	30110	25640	22700	21660	20710	16820	11.2	14.9	2000	4000	100	4B	47600
	726	30110	25640	22700	21660	18420	14960	9.8	13.4	2000	4000	50	4A	47600
	798	30110	25640	22700	21660	20510	16660	8.9	13.7	2000	4000	50	4A	47600
	974	33170	30640	29350	26500	17700	14380	8.1	12.4	2000	4000	50	4A	47600
	1002	30110	25640	22700	21660	20710	16820	7.1	13.0	2000	4000	50	4A	47600
	1164	30110	25640	22700	21660	20710	16820	6.1	12.3	2000	4000	50	4A	47600
	1259	24820	24820	22700	21660	20380	16550	4.7	11.9	2000	4000	50	4A	47600
	1438	23930	20350	18000	17810	17810	16620	3.9	11.4	2000	4000	50	4A	47600
	1672	23930	20350	18000	17810	17810	16620	3.4	10.9	2000	4000	50	4A	47600
	1794	23930	20350	18000	17810	17810	16620	3.2	10.7	2000	4000	50	4A	47600
	2022	23930	20350	18000	17810	17810	16620	2.8	10.4	2000	4000	50	4A	47600
	2523	23930	20350	18000	17810	17810	16620	2.2	9.9	2000	4000	50	4A	47600

311M L



356

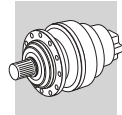

49210 Nm

	i	M _{n2} [Nm]						P ₁	P _{TB}	n ₁	n _{1max}	M _b		M _{2max}
		n _{2-h}	n _{2-h}	n _{2-h}	n _{2-h}	n _{2-h}	n _{2-h}							
L1	4.09	49210	46590	45450	41050	30210	24540	200	*	1500	1800	—	—	58300
	5.25	47810	41400	36690	35010	29500	23960	200	*	1500	1800	—	—	58300
	6.23	36470	31040	27480	27190	27190	23670	200	*	1500	1800	—	—	58300
L2	14.0	32420	32420	32420	32420	25490	20710	115	32	1500	2500	3300	6L	58300
	16.7	49210	46590	45450	40310	24870	20200	115	38	1500	2500	3300	6L	58300
	18.0	41500	41400	36690	35010	29500	23960	115	31	1500	2500	2750	6K	58300
	21.5	47810	41400	36690	35010	23030	18700	115	37	1500	2500	2750	6K	58300
	25.5	33520	32020	32020	32020	23990	19490	115	41	1500	2500	1600	6E	58300
	27.6	47810	41400	36690	35010	28930	23490	115	41	1500	2500	2200	6G	58300
	32.7	41250	41170	36690	35010	28570	23200	115	40	1500	2500	1600	6E	58300
	38.8	36470	31040	27480	27190	27190	23670	115	37	1500	2500	1600	6E	58300
L3	50.5	32420	32420	32420	32420	25490	20710	60	26.8	1800	3800	800	5G	58300
	60.2	49210	46590	45450	40310	24870	20200	60	25.9	1800	3800	1000	5K	58300
	71.1	49210	46590	45450	40310	24870	20200	60	28.2	1800	3800	800	5G	58300
	77.3	47810	41400	36690	35010	29500	23960	60	24.8	1800	3800	800	5G	58300
	89.3	49210	46590	45450	40310	24870	20200	60	27.8	1800	3800	800	5G	58300
	104	49210	46590	45450	40310	24870	20200	60	26.4	1800	3800	800	5G	58300
	115	47810	41400	36690	35010	29500	23960	60	26.6	1800	3800	500	5C	58300
	133	47810	41400	36690	35010	29500	23960	60	25.2	1800	3800	400	5B	58300
	147	47810	41400	36690	35010	28930	23490	60	25.5	1800	3800	400	5B	58300
	161	47810	41400	36690	35010	29500	23960	60	24.0	1800	3800	400	5B	58300
	171	47810	41400	36690	35010	28930	23490	58	24.3	1800	3800	400	5B	58300
	191	33520	32020	32020	32020	23990	19490	36	22.5	1800	3800	400	5B	58300
	203	41250	41170	36690	35010	28570	23200	42	22.6	1800	3800	400	5B	58300
245	41250	41170	36690	35010	28570	23200	35	21.6	1800	3800	400	5B	58300	
291	36470	31040	27480	27190	27190	23670	26	20.5	1800	3800	400	5B	58300	





311M L  356

49210 Nm

	i	M _{n2} [Nm]						P ₁	P _{TB}	n ₁	n _{1max}	M _b		M _{2max}
		n _{2-h} 10000	n _{2-h} 25000	n _{2-h} 50000	n _{2-h} 100000	n _{2-h} 500000	n _{2-h} 1000000							
L4	348	49210	46590	45450	39750	24530	19920	30	18.7	2000	4000	160	4D	58300
	410	49210	46590	45450	40310	24870	20200	28	18.6	2000	4000	160	4D	58300
	512	49210	46590	45450	40310	24870	20200	23	17.2	2000	4000	100	4B	58300
	568	47810	41400	36690	35010	29500	23960	19.9	17.3	2000	4000	100	4B	58300
	627	47810	41400	36690	35010	28930	23490	18.0	17.7	2000	4000	100	4B	58300
	825	47810	41400	36690	35010	29500	23960	13.7	15.7	2000	4000	100	4B	58300
	986	47810	41400	36690	35010	28930	23490	11.5	15.5	2000	4000	50	4A	58300
	1058	47810	41400	36690	35010	28930	23490	10.7	15.2	2000	4000	50	4A	58300
	1230	47810	41400	36690	35010	28930	23490	9.2	14.4	2000	4000	50	4A	58300
	1415	41250	41170	36690	35010	28570	23200	6.9	13.9	2000	4000	50	4A	58300
	1680	36470	31040	27480	27190	27190	23670	5.1	13.4	2000	4000	50	4A	58300
	1766	41250	41170	36690	35010	28570	23200	5.5	13.0	2000	4000	50	4A	58300
	2096	36470	31040	27480	27480	27480	23670	4.1	12.5	2000	4000	50	4A	58300
	1766	43000	39550	35220	32000	19700	16000	5.8	12.5	2000	4000	50	4A	58300
	2096	34000	29500	27000	27000	18600	15100	3.8	11.0	2000	4000	50	4A	58300

313M L  368

60940 Nm

	i	M _{n2} [Nm]						P ₁	P _{TB}	n ₁	n _{1max}	M _b		M _{2max}
		n _{2-h} 10000	n _{2-h} 25000	n _{2-h} 50000	n _{2-h} 100000	n _{2-h} 500000	n _{2-h} 1000000							
L1	4.14	60940	57660	55630	50400	42150	34240	250	*	1000	1300	—	—	105000
	5.40	57130	48690	43150	41430	41090	33380	250	*	1000	1300	—	—	105000
	6.50	40100	34160	30260	30200	30200	30200	250	*	1000	1300	—	—	105000
L2	14.2	48640	48640	48640	48640	35280	28650	150	*	1500	2000	3300	6L	105000
	16.9	60940	57660	55630	50400	34420	27960	150	*	1500	2000	3300	6L	105000
	18.5	57130	48690	43150	41430	41090	33380	150	*	1500	2000	3300	6L	105000
	21.8	60940	57660	55630	50400	33620	27300	150	39	1500	2000	3300	6L	105000
	25.8	50810	48640	48640	48640	33200	26970	150	42	1500	2000	2200	6G	105000
	28.4	57130	48690	43150	41430	40470	32870	150	36	1500	2000	3300	6L	105000
	33.6	57130	48690	43150	41430	39970	32460	150	39	1500	2000	2200	6G	105000
	40.5	40100	34160	30260	30200	30200	30200	133	37	1500	2000	1600	6E	105000
L3	51.1	48640	48640	48640	43750	27000	21930	60	33	1800	3800	1000	5K	105000
	61.0	60940	57660	55630	49510	30550	24820	60	32	1800	3800	1000	5K	105000
	72.0	60940	57660	55630	48740	30080	24430	60	35	1800	3800	1000	5K	105000
	78.3	60940	57660	55630	50400	33620	27300	60	32	1800	3800	1000	5K	105000
	92.4	60940	57660	55630	50400	33620	27300	60	34	1800	3800	800	5G	105000
	110	50810	48640	48640	48640	33200	26970	60	31	1800	3800	800	5G	105000
	120	57130	48690	43150	41430	40470	32870	60	31	1800	3800	500	5C	105000
	135	60940	57660	55630	50400	33620	27300	60	31	1800	3800	500	5C	105000
	143	57130	48690	43150	41430	39970	32460	60	28.9	1800	3800	500	5C	105000
	151	57130	48690	43150	41430	40470	32870	60	31	1800	3800	500	5C	105000
	163	54140	54140	54140	50400	33620	27300	60	29.7	1800	3800	400	5B	105000
	176	57130	48690	43150	41430	40470	32870	60	28.9	1800	3800	400	5B	105000
	182	40100	34160	30260	30200	30200	30200	46	28.9	1800	3800	400	5B	105000
	194	50810	48640	48640	48640	33200	26970	54	27.5	1800	3800	400	5B	105000
209	57130	48690	43150	41430	39970	32460	57	26.9	1800	3800	400	5B	105000	
252	57130	48690	43150	41430	39970	32460	47	25.6	1800	3800	400	5B	105000	
304	40100	34160	30260	30200	30200	30200	27	24.4	1800	3800	400	5B	105000	
L4	394	60940	57660	55630	50400	33620	27300	30	23.6	2000	4000	260	4F	105000
	452	60940	57660	55630	47760	29470	23940	30	21.7	2000	4000	160	4D	105000
	514	57130	48690	43150	41430	40470	32870	26	22.0	2000	4000	160	4D	105000
	564	54240	54240	54240	46390	28620	23250	23	20.0	2000	4000	160	4D	105000
	633	50810	48640	48640	48640	33200	26970	19.0	20.2	2000	4000	100	4B	105000
	695	57130	48690	43150	41430	39840	32360	19.4	20.2	2000	4000	100	4B	105000
	790	50810	48640	48640	48640	33200	26970	15.2	18.8	2000	4000	100	4B	105000



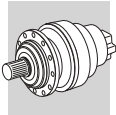

313M L



368

60940 Nm

i	1:	M _{n2} [Nm]						P ₁ [kW]	P _{TB} [kW]	n ₁ [min ⁻¹]	n _{1max} [min ⁻¹]	M _b [Nm]	M _{2max} [Nm]	
		n _{2-h} 10000	n _{2-h} 25000	n _{2-h} 50000	n _{2-h} 100000	n _{2-h} 500000	n _{2-h} 1000000							
L4	889	57130	48690	43150	41430	39970	32460	15.2	18.4	2000	4000	100	4B	105000
	1014	57130	48690	43150	41430	40470	32870	13.3	18.0	2000	4000	100	4B	105000
	1117	50810	48640	48640	48640	33200	26970	10.8	17.0	2000	4000	50	4A	105000
	1266	57130	48690	43150	41430	40470	32870	10.7	16.8	2000	4000	50	4A	105000
	1394	50810	48640	48640	48640	33200	26970	8.6	16.0	2000	4000	50	4A	105000
	1502	57130	48690	43150	41430	39970	32460	9.0	15.9	2000	4000	50	4A	105000
	1817	57130	48690	43150	41430	39970	32460	7.4	15.1	2000	4000	50	4A	105000
	2187	40100	34160	30260	30200	30200	30200	4.3	14.7	2000	4000	50	4A	105000
	2187	49000	42400	39000	39000	27700	22500	5.3	11.0	2000	4000	50	4A	105000

314M L



380

80640 Nm

i	1:	M _{n2} [Nm]						P ₁ [kW]	P _{TB} [kW]	n ₁ [min ⁻¹]	n _{1max} [min ⁻¹]	M _b [Nm]	M _{2max} [Nm]	
		n _{2-h} 10000	n _{2-h} 25000	n _{2-h} 50000	n _{2-h} 100000	n _{2-h} 500000	n _{2-h} 1000000							
L1	4.25	80640	75688	75688	71136	53888	43776	260	*	500	900	—	—	115000
	5.33	73304	67496	62304	59712	52048	42280	260	*	500	900	—	—	115000
	6.20	63256	54024	47944	47400	47400	41792	260	*	500	900	—	—	115000
L2	17.4	80640	75688	75688	71136	45288	36784	175	*	1500	1800	—	—	115000
	22.3	78024	72424	72424	71136	44248	35936	175	54	1500	1800	—	—	115000
	26.5	61848	59488	59488	59488	43712	35504	175	58	1500	1800	—	—	115000
	28.0	73304	67496	62304	59712	51864	42128	175	53	1500	1800	—	—	115000
	33.2	73304	67496	62304	59712	51240	41616	175	55	1500	1800	—	—	115000
	38.6	63256	54024	47944	47400	47400	41792	175	54	1500	1800	—	—	115000
L3	62.6	80640	75688	75688	63944	39456	32048	75	54	1600	3000	1600	6E	115000
	73.9	80640	75688	75688	62952	38840	31552	75	59	1600	3000	1600	6E	115000
	92.7	80640	75688	75464	61296	37824	30720	75	56	1600	3000	1600	6E	115000
	108	80640	75688	74784	60744	37480	30448	75	52	1600	3000	1600	6E	115000
	138	78024	72424	72424	71136	44248	35936	75	50	1600	3000	1600	6E	115000
	164	61848	59488	59488	59488	43712	35504	69	45	1600	3000	1200	6C	115000
	174	73304	67496	62304	59712	51864	42128	75	47	1600	3000	1200	6C	115000
	206	73304	67496	62304	59712	51240	41616	65	42	1600	3000	900	6B	115000
	240	63256	54024	47944	47400	47400	41792	48	41	1600	3000	900	6B	115000
	L4	314	80640	75688	75688	61800	38128	30976	40	41	1800	3800	400	5B
394		80640	75696	74080	60176	37128	30160	40	38	1800	3800	400	5B	115000
458		80640	75688	73416	59632	36800	29888	37	36	1800	3800	400	5B	115000
495		80640	75688	75464	61296	37824	30720	35	36	1800	3800	400	5B	115000
575		73304	67496	62304	59712	43136	35040	27	34	1800	3800	400	5B	115000
588		78024	72424	72424	71136	44248	35936	28	34	1800	3800	400	5B	115000
668		80640	75688	74784	60744	37480	30448	26	31	1800	3800	400	5B	115000
738		78024	72424	72424	71136	44248	35936	23	32	1800	3800	400	5B	115000
858		78024	72424	72424	71136	44248	35936	19	30	1800	3800	400	5B	115000
926		73304	67496	62304	59712	51864	42128	16.9	31	1800	3800	400	5B	115000
1038		78024	72424	72424	71136	44248	35936	16.0	28.3	1800	3800	400	5B	115000
1099		73304	67496	62304	59712	51240	41616	14.2	28.4	1800	3800	400	5B	115000
1277		73304	67496	62304	59712	51240	41616	12.2	27.0	1800	3800	400	5B	115000
1485		63256	54024	47944	47400	47400	41792	9.1	26.3	1800	3800	400	5B	115000
1796	63256	54024	47944	47400	47400	41792	7.5	24.8	1800	3800	400	5B	115000	

C

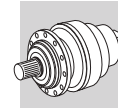



315M L



392

100800 Nm

	i	M _{n2} [Nm]						P ₁	P _{TB}	n ₁	n _{1max}	M _b		M _{2max}
		n _{2-h} 10000	n _{2-h} 25000	n _{2-h} 50000	n _{2-h} 100000	n _{2-h} 500000	n _{2-h} 1000000							
L1	4.25	100800	94610	94610	88920	67360	54720	260	*	500	900	—	—	135000
	5.33	91630	84370	77880	74640	65060	52850	260	*	500	900	—	—	135000
	6.20	79070	67530	59930	59250	59250	52240	260	*	500	900	—	—	135000
L2	17.4	100800	94610	94610	88920	67360	54720	200	*	1500	1800	—	—	135000
	22.3	100800	94610	94610	88920	67360	54720	200	47	1500	1800	—	—	135000
	26.5	100800	94610	94610	88920	67360	54720	200	60	1500	1800	—	—	135000
	28.0	91630	84370	77880	74640	65060	52850	200	47	1500	1800	—	—	135000
	33.2	91630	84370	77880	74640	65060	52850	200	57	1500	1800	—	—	135000
	38.6	79070	67530	59930	59250	59250	52240	200	56	1500	1800	—	—	135000
L3	59.6	100800	94610	94610	88920	67360	54720	115	55	1500	2500	2750	6K	135000
	71.1	100800	94610	94610	88920	66430	53960	115	58	1500	2500	2200	6G	135000
	91.3	100800	94610	94610	88920	64880	52700	115	60	1500	2500	1600	6E	135000
	108	100800	94610	94610	88920	64070	52040	115	56	1500	2500	1200	6C	135000
	139	100800	94610	94610	88920	67360	54720	115	53	1500	2500	900	6B	135000
	165	100800	94610	94610	88920	67360	54720	105	50	1500	2500	900	6B	135000
	174	91630	84370	77880	74640	65060	52850	90	50	1500	2500	900	6B	135000
	207	91630	84370	77880	74640	65060	52850	76	47	1500	2500	900	6B	135000
	241	79070	67530	59930	59250	59250	52240	57	46	1500	2500	900	6B	135000
	L4	302	100800	94610	94610	88920	66430	53960	60	40	1800	3800	400	5B
370		100800	94610	94610	88920	67360	54720	58	39	1800	3800	400	5B	135000
441		100800	94610	94610	88920	66430	53960	49	37	1800	3800	400	5B	135000
487		100800	94610	94610	88920	64880	52700	44	37	1800	3800	400	5B	135000
533		100800	94610	94610	88920	66430	53960	40	35	1800	3800	400	5B	135000
591		100800	94610	94610	88920	67360	54720	36	34	1800	3800	400	5B	135000
672		100800	94610	94610	88920	64070	52040	32	33	1800	3800	400	5B	135000
741		100800	94610	94610	88920	67360	54720	29	33	1800	3800	400	5B	135000
862		100800	94610	94610	88920	67360	54720	25	32	1800	3800	400	5B	135000
930		91630	84370	77880	74640	65060	52850	21	32	1800	3800	400	5B	135000
1043		100800	94610	94610	88920	67360	54720	21	30	1800	3800	400	5B	135000
1104		91630	84370	77880	74640	65060	52850	17.7	30	1800	3800	400	5B	135000
1284		91630	84370	77880	74640	65060	52850	15.2	28.9	1800	3800	400	5B	135000
1492		79070	67530	59930	59250	59250	52240	11.3	28.1	1800	3800	400	5B	135000
1805		79070	67530	59930	59250	59250	52240	9.3	26.8	1800	3800	400	5B	135000





316M L



404

134390 Nm

	i	M _{n2} [Nm]						P ₁	P _{TB}	n ₁	n _{1max}	M _b		M _{2max}
		n _{2-h} 10000	n _{2-h} 25000	n _{2-h} 50000	n _{2-h} 100000	n _{2-h} 500000	n _{2-h} 1000000							
L1	4.25	134390	126150	123700	118560	89820	72960	280	*	350	500	—	—	192000
	5.33	122190	111300	99520	99520	86750	70460	280	*	350	500	—	—	192000
L2	17.4	134390	126150	123700	118560	80680	65530	200	*	1500	1800	—	—	192000
	21.8	122190	111300	99520	99520	86750	70460	200	*	1500	1800	—	—	192000
	22.3	134390	126150	123700	118560	78790	64000	200	49	1500	1800	—	—	192000
	26.5	118110	113640	113640	113640	77820	63210	200	64	1500	1800	—	—	192000
	28.0	122190	111300	99520	99520	86750	70460	200	52	1500	1800	—	—	192000
	33.2	122190	111300	99520	99520	86750	70460	200	62	1500	1800	—	—	192000
L3	59.6	129890	126150	123700	110340	68080	55300	115	61	1500	2500	3300	6L	192000
	71.1	134390	126150	123700	107660	66430	53960	115	64	1500	2500	2750	6K	192000
	76.5	134390	126150	123700	118560	78790	64000	115	59	1500	2500	2200	6G	192000
	89.3	122190	111300	99520	99520	77870	63250	115	59	1500	2500	2200	6G	192000
	96.0	122190	111300	99520	99520	86750	70460	115	55	1500	2500	1600	6E	192000
	114	122190	111300	99520	99520	86750	70460	115	52	1500	2500	1600	6E	192000
	117	134390	126150	123700	118560	77250	62750	115	61	1500	2500	1600	6E	192000
	139	134390	126150	123700	118560	76300	61980	115	58	1500	2500	1600	6E	192000
	165	118110	113640	113640	113640	77820	63210	115	54	1500	2500	1200	6C	192000
	L3	174	122190	111300	99520	99520	86750	70460	115	54	1500	2500	1200	6C
207		122190	111300	99520	99520	86750	70460	102	51	1500	2500	1200	6C	192000

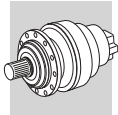

316M L



404

134390 Nm

	i	M _{n2} [Nm]						P ₁	P _{TB}	n ₁	n _{1max}	M _b		M _{2max}
		n _{2-h}	n _{2-h}	n _{2-h}	n _{2-h}	n _{2-h}	n _{2-h}							
	1:	10000	25000	50000	100000	500000	1000000							
L4	215	129890	126150	123700	110340	68080	55300	60	45	1800	3800	800	5G	192000
	253	129890	126150	123700	110340	68080	55300	60	46	1800	3800	800	5G	192000
	275	134390	126150	123700	118560	78790	64000	60	43	1800	3800	630	5E	192000
	318	129890	126150	123700	110340	68080	55300	60	44	1800	3800	630	5E	192000
	346	122190	111300	99520	99520	86750	70460	60	40	1800	3800	500	5C	192000
	399	122190	111300	99520	99520	79810	64830	60	42	1800	3800	400	5B	192000
	447	129890	126150	123700	107360	66240	53810	60	39	1800	3800	400	5B	192000
	500	134390	126150	123700	118560	76300	61980	57	36	1800	3800	400	5B	192000
	563	118110	113640	113640	113640	77820	63210	45	38	1800	3800	400	5B	192000
	628	122190	111300	99520	99520	86750	70460	41	34	1800	3800	400	5B	192000
	706	122190	111300	99520	99520	86750	70460	37	36	1800	3800	400	5B	192000
	784	122190	111300	99520	99520	86750	70460	33	36	1800	3800	400	5B	192000
	880	118110	113640	113640	113640	77820	63210	29	34	1800	3800	400	5B	192000
	1020	122190	111300	99520	99520	75110	61010	26	32	1800	3800	400	5B	192000
	1104	122190	111300	99520	99520	86750	70460	24	32	1800	3800	400	5B	192000
	1237	118110	113640	113640	113640	77820	63210	20	31	1800	3800	400	5B	192000
	1308	122190	111300	99520	99520	86750	70460	19.9	31	1800	3800	400	5B	192000
1553	122190	111300	99520	99520	86750	70460	16.8	29.7	1800	3800	400	5B	192000	

317M L



414

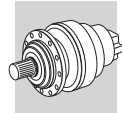

207490 Nm

	i	M _{n2} [Nm]						P ₁	P _{TB}	n ₁	n _{1max}	M _b		M _{2max}
		n _{2-h}	n _{2-h}	n _{2-h}	n _{2-h}	n _{2-h}	n _{2-h}							
	1:	10000	25000	50000	100000	500000	1000000							
L1	4.09	207490	196240	189230	171410	121500	98690	300	*	200	300	—	—	393000
	5.25	195640	167510	148950	142330	118660	96380	300	*	200	300	—	—	393000
	6.23	150260	128480	114130	112960	112960	95190	300	*	200	300	—	—	393000
L2	16.9	207490	196240	189230	171410	109610	89030	250	46	1000	1300	—	—	393000
	22.1	179820	166930	166930	166930	106860	86800	250	66	1000	1300	—	—	393000
	26.6	125790	121300	121300	121300	103860	84360	250	69	1000	1300	—	—	393000
	28.4	195640	167510	148950	142330	118660	96380	250	64	1000	1300	—	—	393000
	34.1	155950	155950	148950	142330	118660	96380	250	67	1000	1300	—	—	393000
	40.5	150260	128480	114130	112960	112960	95190	250	61	1000	1300	—	—	393000
L3	58.1	187760	187760	183040	148670	91740	74510	150	34	1500	2000	2750	6K	393000
	69.3	207490	196240	178590	145060	89510	72700	150	47	1500	2000	2750	6K	393000
	89.0	207490	196240	174410	141670	87410	71000	150	58	1500	2000	2750	6K	393000
	106	193690	193690	172260	139920	86340	70130	150	58	1500	2000	2200	6G	393000
	116	179820	166930	166930	166930	105230	85470	150	54	1500	2000	2200	6G	393000
	138	179820	166930	166930	166930	103930	84420	150	54	1500	2000	1600	6E	393000
	166	125790	121300	121300	121300	103860	84360	131	51	1500	2000	1200	6C	393000
	179	155950	155950	148950	142330	118660	96380	150	49	1500	2000	1200	6C	393000
	213	155950	155950	148950	142330	118660	96380	126	49	1500	2000	900	6B	393000
	252	150260	128480	114130	112960	112960	95190	102	45	1500	2000	900	6B	393000
L4	378	207500	196240	174410	141670	87410	71000	60	45	1800	3800	800	5G	393000
	449	193690	193690	172260	139920	86340	70130	60	42	1800	3800	500	5C	393000
	493	179820	166930	166930	166930	105230	85470	60	42	1800	3800	400	5B	393000
	552	207490	196240	174410	141670	87410	71000	60	41	1800	3800	400	5B	393000
	619	179820	166930	166930	166930	105230	85470	60	40	1800	3800	400	5B	393000
	719	179820	166930	166930	166930	105230	85470	53	38	1800	3800	400	5B	393000
	792	193690	193690	172260	139920	86340	70130	52	37	1800	3800	400	5B	393000
	904	155950	155950	148950	142330	118660	96380	37	36	1800	3800	400	5B	393000
	1032	179820	166930	166930	166930	103930	84420	37	34	1800	3800	400	5B	393000
	1134	155950	155950	148950	142330	118660	96380	29	35	1800	3800	400	5B	393000
	1318	155950	155950	148950	142330	118660	96380	25	33	1800	3800	400	5B	393000
	1595	155950	155950	148950	142330	118660	96380	21	32	1800	3800	400	5B	393000
	1893	150260	128480	114130	112960	112960	95190	16.9	30	1800	3800	400	5B	393000





318M L  424

297550 Nm

	i	M _{n2} [Nm]						P ₁	P _{TB}	n ₁	n _{1max}	M _b		M _{2max}	
		n _{2-h} 1: 10000	n _{2-h} 25000	n _{2-h} 50000	n _{2-h} 100000	n _{2-h} 500000	n _{2-h} 1000000								[kW]
L1	4.40	297550	260520	231720	223900	160590	130440	340	*	200	300	—	—	500000	
	L2	18.7	297550	260520	231720	223900	160590	130440	260	131	500	900	—	—	500000
		23.5	297550	260520	231720	223900	160590	130440	260	127	500	900	—	—	500000
L3	27.3	264700	256140	231720	223900	160590	130440	260	123	500	900	—	—	500000	
	76.5	297550	260520	231720	223900	160590	130440	200	58	1500	1800	3300	6L	500000	
	98.2	297550	260520	231720	223900	160590	130440	200	77	1500	1800	3300	6L	500000	
	117	297550	260520	231720	223900	160590	130440	200	80	1500	1800	3300	6L	500000	
	123	297550	260520	231720	223900	160590	130440	200	74	1500	1800	3300	6L	500000	
L4	146	297550	260520	231720	223900	160590	130440	200	75	1500	1800	2750	6K	500000	
	170	264700	256140	231720	223900	160590	130440	200	73	1500	1800	2200	6G	500000	
	262	297550	260520	231720	223900	160590	130440	115	69	1500	2500	1600	6E	500000	
	313	297550	260520	231720	223900	160590	130440	115	70	1500	2500	1200	6C	500000	
	337	297550	260520	231720	223900	160590	130440	115	66	1500	2500	1200	6C	500000	
	402	297550	260520	231720	223900	160590	130440	115	69	1500	2500	900	6B	500000	
	422	297550	260520	231720	223900	160590	130440	115	62	1500	2500	900	6B	500000	
	477	297550	260520	231720	223900	160590	130440	111	66	1500	2500	900	6B	500000	
	515	297550	260520	231720	223900	160590	130440	102	65	1500	2500	900	6B	500000	
	612	297550	260520	231720	223900	160590	130440	86	62	1500	2500	900	6B	500000	
	647	297550	260520	231720	223900	160590	130440	82	62	1500	2500	900	6B	500000	
	726	297550	260520	231720	223900	160590	130440	73	59	1500	2500	900	6B	500000	
	768	297550	260520	231720	223900	160590	130440	69	59	1500	2500	900	6B	500000	
911	297550	260520	231720	223900	160590	130440	58	56	1500	2500	900	6B	500000		
1059	264700	256140	231720	223900	160590	130440	44	54	1500	2500	900	6B	500000		

319 L  434

471190 Nm



	i	M _{n2} [Nm]						P ₁	P _{TB}	n ₁	n _{1max}	M _b		M _{2max}
		n _{2-h} 1: 10000	n _{2-h} 25000	n _{2-h} 50000	n _{2-h} 100000	n _{2-h} 500000	n _{2-h} 1000000							
L1	4.88	471190	383900	311830	253280	156280	126940	380	*	200	300	—	—	680000
	5.77	356270	305830	272430	249240	153790	124910	380	*	200	300	—	—	680000
L2	20.7	471190	383900	311830	253280	156280	126940	260	165	500	900	—	—	680000
	24.5	356270	305830	272430	249240	153790	124910	260	157	500	900	—	—	680000
	26.0	471190	383900	311830	253280	156280	126940	260	162	500	900	—	—	680000
	30.8	356270	305830	272430	249240	153790	124910	260	155	500	900	—	—	680000
	35.8	336430	305830	272430	249240	153790	124910	260	155	500	900	—	—	680000
L3	84.8	471190	383900	311830	253280	156280	126940	200	85	1500	1800	—	—	680000
	100	356270	305830	272430	249240	153790	124910	200	84	1500	1800	—	—	680000
	109	471190	383900	311830	253280	156280	126940	200	106	1500	1800	—	—	680000
	126	356270	305830	272430	249240	153790	124910	200	85	1500	1800	—	—	680000
	129	443030	383900	311830	253280	156280	126940	200	108	1500	1800	—	—	680000
	137	471190	383900	311830	253280	156280	126940	200	102	1500	1800	—	—	680000
	162	356270	305830	272430	249240	153790	124910	200	98	1500	1800	—	—	680000
	188	288420	284000	283990	253280	156280	126940	200	97	1500	1800	—	—	680000
	192	356270	305830	272430	249240	153790	124910	200	98	1500	1800	—	—	680000
	223	336430	305830	272430	249240	153790	124910	200	94	1500	1800	—	—	680000
	L4	291	471190	383900	311830	253280	156280	126940	115	92	1500	2500	2200	6G
347		471190	383900	311830	253280	156280	126940	115	91	1500	2500	2200	6G	680000
410		356270	305830	272430	249240	153790	124910	115	89	1500	2500	1200	6C	680000
445		471190	383900	311830	253280	156280	126940	115	89	1500	2500	2200	6G	680000
515		356270	305830	272430	249240	153790	124910	115	84	1500	2500	900	6B	680000
528		406490	383900	311830	253280	156280	126940	115	83	1500	2500	900	6B	680000
558		471190	383900	311830	253280	156280	126940	115	84	1500	2500	900	6B	680000
571		443030	383900	311830	253280	156280	126940	115	82	1500	2500	900	6B	680000
625		356270	305830	272430	249240	153790	124910	101	82	1500	2500	900	6B	680000
678		433020	383900	311830	253280	156280	126940	113	78	1500	2500	900	6B	680000

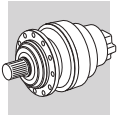





319 L  434

471190 Nm

	i	M _{n2} [Nm]						P ₁	P _{TB}	n ₁	n _{1max}	M _b		M _{2max}
		n _{2-h} 10000	n _{2-h} 25000	n _{2-h} 50000	n _{2-h} 100000	n _{2-h} 500000	n _{2-h} 1000000							
L4	717	471190	383900	311830	253280	156280	126940	115	79	1500	2500	900	6B	680000
	802	356270	305830	272430	249240	153790	124910	79	78	1500	2500	900	6B	680000
	850	438750	383900	311830	253280	156280	126940	92	75	1500	2500	900	6B	680000
	912	336430	305830	272430	249240	153790	124910	65	71	1500	2500	900	6B	680000
	1007	356270	305830	272430	249240	153790	124910	63	72	1500	2500	900	6B	680000
	1195	356270	305830	272430	249240	153790	124910	53	68	1500	2500	900	6B	680000
	1389	336430	305830	272430	249240	153790	124910	43	66	1500	2500	900	6B	680000



321 L  444

655740 Nm

	i	M _{n2} [Nm]						P ₁	P _{TB}	n ₁	n _{1max}	M _b		M _{2max}	
		n _{2-h} 10000	n _{2-h} 25000	n _{2-h} 50000	n _{2-h} 100000	n _{2-h} 500000	n _{2-h} 1000000								[kW]
L1	4.44	655740	517290	420170	341290	210580	171050	540	*	200	300	—	—	934000	
	L2	18.2	655740	517290	420170	341290	210580	171050	300	*	200	300	—	—	934000
		23.3	655740	517290	420170	341290	210580	172000	300	*	200	300	—	—	934000
		27.7	536350	517290	420170	341290	210580	171050	300	*	200	300	—	—	934000
L3	75.3	655740	517290	420170	341290	210580	171050	250	132	1000	1200	—	—	934000	
	98.2	655740	517290	420170	341290	210580	171050	250	135	1000	1200	—	—	934000	
	118	655740	517290	420170	341290	210580	171050	250	132	1000	1200	—	—	934000	
	126	655740	517290	420170	341290	210580	172000	250	127	1000	1200	—	—	934000	
	152	655740	517290	420170	341290	210580	172000	250	125	1000	1200	—	—	934000	
	180	536350	517290	420170	341290	210580	171050	250	115	1000	1200	—	—	934000	
	L4	258	655740	517290	420170	341290	210580	171050	150	101	1500	2000	2200	6G	934000
308		655740	517290	420170	341290	210580	171050	150	105	1500	2000	2200	6G	934000	
395		655740	517290	420170	341290	210580	171050	150	107	1500	2000	2200	6G	934000	
469		655740	517290	420170	341290	210580	171050	150	103	1500	2000	1600	6E	934000	
515		655740	517290	420170	341290	210580	171050	150	98	1500	2000	1600	6E	934000	
612		655740	517290	420170	341290	210580	171050	150	95	1500	2000	1200	6C	934000	
736		655740	517290	420170	341290	210580	171050	130	90	1500	2000	900	6B	934000	
796		655740	517290	420170	341290	210580	172000	120	88	1500	2000	900	6B	934000	
945		655740	517290	420170	341290	210580	172000	101	86	1500	2000	900	6B	934000	
1122		536350	517290	420170	341290	210580	171050	79	81	1500	2000	900	6B	934000	

323 L  454

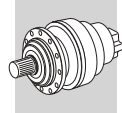

890310 Nm

	i	M _{n2} [Nm]						P ₁	P _{TB}	n ₁	n _{1max}	M _b		M _{2max}	
		n _{2-h} 10000	n _{2-h} 25000	n _{2-h} 50000	n _{2-h} 100000	n _{2-h} 500000	n _{2-h} 1000000								[kW]
L1	4.60	890310	829940	742050	602740	371910	302080	850	*	150	250	—	—	1580000	
	L2	19.6	890310	829940	742050	602740	371910	302080	380	*	200	300	—	—	1580000
		22.4	890310	829940	742050	602740	371910	302080	380	*	200	300	—	—	1580000
		26.5	890310	829940	742050	602740	371910	302080	380	*	200	300	—	—	1580000
		33.1	890310	829940	742050	602740	371910	302080	380	*	200	300	—	—	1580000
L3	83.3	890310	829940	742050	602740	371910	302080	260	179	500	800	—	—	1580000	
	105	890310	829940	742050	602740	371910	302080	260	167	500	800	—	—	1580000	
	113	890310	829940	742050	602740	371910	302080	260	157	500	800	—	—	1580000	
	120	890310	829940	742050	602740	371910	302080	260	155	500	800	—	—	1580000	
	142	890310	829940	742050	602740	371910	302080	260	149	500	800	—	—	1580000	
	165	890310	829940	742050	602740	371910	302080	260	144	500	800	—	—	1580000	
	205	890310	829940	742050	602740	371910	302080	210	135	500	800	—	—	1580000	
	L4	341	890310	829940	742050	602740	371910	302080	200	97	1500	1800	3300	6L	1580000
390		890310	829940	742050	602740	371910	302080	200	93	1500	1800	3300	6L	1580000	





323 L  454

890310 Nm

	i	M _{n2} [Nm]						P ₁	P _{TB}	n ₁	n _{1max}	M _b		M _{2max}
		n _{2-h} 10000	n _{2-h} 25000	n _{2-h} 50000	n _{2-h} 100000	n _{2-h} 500000	n _{2-h} 1000000							
L4	438	890310	829940	742050	602740	371910	302080	200	109	1500	1800	3300	6L	1580000
	500	890310	829940	742050	602740	371910	302080	200	102	1500	1800	3300	6L	1580000
	569	890310	829940	742050	602740	371910	302080	200	87	1500	1800	2750	6K	1580000
	628	890310	829940	742050	602740	371910	302080	200	96	1500	1800	2750	6K	1580000
	703	890310	829940	742050	602740	371910	302080	197	99	1500	1800	2750	6K	1580000
	758	890310	829940	742050	602740	371910	302080	182	97	1500	1800	2750	6K	1580000
	882	890310	829940	742050	602740	371910	302080	157	92	1500	1800	2750	6K	1580000
	1025	890310	829940	742050	602740	371910	302080	135	89	1500	1800	2750	6K	1580000
	1101	890310	829940	742050	602740	371910	302080	126	88	1500	1800	2750	6K	1580000
1280	890310	829940	742050	602740	371910	302080	108	85	1500	1800	2750	6K	1580000	

325 L  458

1286700 Nm

	i	M _{n2} [Nm]						P ₁	P _{TB}	n ₁	n _{1max}	M _b		M _{2max}
		n _{2-h} 10000	n _{2-h} 25000	n _{2-h} 50000	n _{2-h} 100000	n _{2-h} 500000	n _{2-h} 1000000							
L1	4.60	1286700	1166950	947860	769900	475050	385860	1050	*	120	250	—	—	2000000
L2	19.6	1286600	1104050	896760	729000	449450	365060	380	*	200	300	—	—	2000000
	22.4	1286700	1083740	880270	715000	441180	358350	380	*	200	300	—	—	2000000
	26.5	1286700	1066430	866210	703580	434130	352630	380	*	200	300	—	—	2000000
	33.1	963170	963170	845000	686160	423380	343890	380	*	200	300	—	—	2000000
L3	83.3	1286600	1104050	896760	728400	449450	365060	260	206	500	800	—	—	2000000
	105	1286600	1104050	896760	728400	449450	365060	260	192	500	800	—	—	2000000
	113	1286700	1066430	866210	703580	434130	352630	260	181	500	800	—	—	2000000
	120	1286700	1083740	880270	715000	441180	358350	260	177	500	800	—	—	2000000
	142	1286700	1066430	866210	703580	434130	352630	260	170	500	800	—	—	2000000
	165	1286700	1066430	866210	703580	434130	352630	260	164	500	800	—	—	2000000
	205	963170	963170	845000	686160	423380	343890	226	154	500	800	—	—	2000000
L4	341	1286600	1104050	896760	728400	449450	365060	200	120	1500	1800	3300	6L	2000000
	390	1286700	1083740	880270	715000	441180	358350	200	113	1500	1800	3300	6L	2000000
	438	1286600	1104050	896760	728400	449450	365060	200	128	1500	1800	3300	6L	2000000
	500	1286700	1083740	880270	715000	441180	358350	200	120	1500	1800	3300	6L	2000000
	569	1286700	1083740	880270	715000	441180	358350	200	105	1500	1800	3300	6L	2000000
	628	1286700	1083740	880270	715000	441180	358350	200	113	1500	1800	3300	6L	2000000
	703	1286700	1066430	866210	703580	434130	352630	200	115	1500	1800	3300	6L	2000000
	758	1286600	1104050	896760	728400	449450	365060	200	113	1500	1800	2750	6K	2000000
	882	1286700	1066430	866210	703580	434130	352630	200	108	1500	1800	2750	6K	2000000
	1025	1286700	1066430	866210	703580	434130	352630	193	104	1500	1800	2750	6K	2000000
	1101	963170	963170	845120	686350	423550	343890	135	102	1500	1800	2750	6K	2000000
1280	963170	963170	845120	686350	423550	343890	116	99	1500	1800	2750	6K	2000000	

C

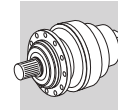

25.8 RATING CHARTS FOR RIGHT ANGLE UNITS 300M R

Reading the rating chart.

		<div style="display: flex; justify-content: space-between; align-items: center;"> 12 370 </div>						<div style="display: flex; justify-content: space-between; align-items: center;"> 1 49210 Nm </div>						
R4	i	M _{n2} [Nm]						P ₁ [kW]	P _{TB} [kW]	n ₁ [min ⁻¹]	n _{1max} [min ⁻¹]	M _b [Nm]		M _{2max} [Nm]
		n ₂ ·h 10000	n ₂ ·h 25000	n ₂ ·h 50000	n ₂ ·h 100000	n ₂ ·h 500000	n ₂ ·h 1000000							
	1:	10000	25000	50000	100000	500000	1000000	[kW]	[kW]	[min ⁻¹]	[min ⁻¹]	[Nm]		[Nm]
	294	47810	41400	36690	35010	24670	20040	35	21.6	2000	4000	160	4D	58300
	341	47810	41400	36690	35010	27410	22260	33	20.3	2000	4000	160	4D	58300
	413	47810	41400	36690	35010	29500	23960	27	19.2	2000	4000	160	4D	58300
	438	47810	41400	36690	35010	28930	23490	26	19.6	2000	4000	100	4D	58300
	490	33520	32020	32020	32020	23990	19490	16.2	18.1	2000	4000	100	4B	58300

* **BONFIGLIOLI**
TECHNICAL SERVICE

Rated hydraulic brake torque lower than applicable torque

<p>1 Reference torque</p> <hr/> <p>2 Number of reduction stages (right-angled gear unit)</p> <hr/> <p>3 Gear ratio</p> <hr/> <p>Gearbox rated output torque based on:</p> <p>4 - service factor $f_S=1$ - $n_2 \cdot h$ indicated</p> <hr/> <p>5 Maximum power transmitted to the input shaft</p> <hr/> <p>6 Gearbox thermal capacity</p>	<p>7 Input angular speed for continuous duty</p> <hr/> <p>8 Maximum input angular speed for intermittent duty 20% based 60 min running</p> <hr/> <p>9 Rated brake torque (Hydraulic brake)</p> <hr/> <p>10 Negative multidisc hydraulic brake</p> <hr/> <p>11 Maximum output torque at gearbox</p> <hr/> <p>12 Page where dimensions can be sorted from</p>
---	---



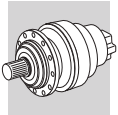

300 R

254

1250 Nm

	i	M _{n2} [Nm]						P ₁	P _{TB}	n ₁	n _{1max}	M _b		M _{2max}	
		n _{2-h}	n _{2-h}	n _{2-h}	n _{2-h}	n _{2-h}	n _{2-h}								[kW]
R2	7.13	760	730	730	730	730	730	15.0	12.3	2000	4000	160	4D	2000	
	8.74	1250	1070	950	860	840	720	15.0	12.3	2000	4000	160	4D	2400	
	11.8	860	730	650	650	650	630	12.2	10.1	2000	4000	100	4B	2400	
	14.8	700	600	550	550	550	510	8.3	8.8	2000	4000	100	4B	2400	
	18.5	460	390	370	370	370	370	4.5	8.4	2000	4000	100	4B	2400	
R3	24.8	760	730	730	730	730	730	6.2	7.8	2000	4000	50	4A	2000	
	30.4	1250	1070	950	860	840	720	6.6	7.8	2000	4000	50	4A	2400	
	37.3	1250	1070	950	860	840	720	5.5	7.9	2000	4000	50	4A	2400	
	41.2	860	730	650	650	650	630	3.6	6.9	2000	4000	50	4A	2400	
	50.4	1250	1070	950	860	840	720	4.3	7.1	2000	4000	50	4A	2400	
	62.9	1250	1070	950	860	840	720	3.5	6.5	2000	4000	50	4A	2400	
	68.2	860	730	650	650	650	630	2.4	6.3	2000	4000	50	4A	2400	
	78.7	1250	1070	950	860	840	720	2.9	6.2	2000	4000	50	4A	2400	
	85.2	860	730	650	650	650	630	2.0	5.8	2000	4000	50	4A	2400	
	106	860	730	650	650	650	630	1.7	5.6	2000	4000	50	4A	2400	
	133	700	600	550	550	550	510	1.2	5.2	2000	4000	50	4A	2400	
	R4	106	1250	1070	950	860	840	720	2.2	5.7	2000	4000	50	4A	2400
		130	1250	1070	950	860	840	720	1.8	5.7	2000	4000	50	4A	2400
143		860	730	650	650	650	630	1.4	5.1	2000	4000	50	4A	2400	
159		1250	1070	950	860	840	720	1.5	5.7	2000	4000	50	4A	2400	
175		1250	1070	950	860	840	720	1.3	5.3	2000	4000	50	4A	2400	
215		1250	1070	950	860	840	720	1.1	5.3	2000	4000	50	4A	2400	
237		860	730	650	650	650	630	0.86	4.9	2000	4000	50	4A	2400	
268		1250	1070	950	860	840	720	0.88	5.0	2000	4000	50	4A	2400	
291		1250	1070	950	860	840	720	0.81	4.8	2000	4000	50	4A	2400	
363		1250	1070	950	860	840	720	0.65	4.6	2000	4000	50	4A	2400	
394		860	730	650	650	650	630	0.52	4.5	2000	4000	50	4A	2400	
453		1250	1070	950	860	840	720	0.52	4.3	2000	4000	50	4A	2400	
491		860	730	650	650	650	630	0.41	4.3	2000	4000	50	4A	2400	
613		860	730	650	650	650	630	0.33	4.1	2000	4000	50	4A	2400	
766	860	730	650	650	650	630	0.27	4.0	2000	4000	50	4A	2400		

301 R

264

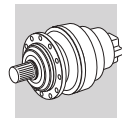

2060 Nm

	i	M _{n2} [Nm]						P ₁	P _{TB}	n ₁	n _{1max}	M _b		M _{2max}	
		n _{2-h}	n _{2-h}	n _{2-h}	n _{2-h}	n _{2-h}	n _{2-h}								[kW]
R2	7.13	1490	1430	1430	1430	1430	1300	15.0	13.9	2000	4000	260	4F	3200	
	8.74	2060	2060	1890	1730	1580	1280	15.0	14.4	2000	4000	330	4H	3200	
	11.8	1720	1460	1300	1300	1300	1240	15.0	12.2	2000	4000	260	4F	3200	
	14.8	1150	1150	1150	1150	1150	940	15.0	10.7	2000	4000	160	4D	3200	
	18.5	920	780	740	740	740	740	8.0	10.1	2000	4000	160	4D	3200	
R3	24.8	1490	1430	1430	1430	1430	1300	12.4	8.9	2000	4000	100	4B	3400	
	30.4	2460	2140	1900	1730	1580	1280	13.1	9.0	2000	4000	100	4B	3400	
	37.3	2460	2140	1900	1730	1580	1280	10.8	9.0	2000	4000	100	4B	3400	
	41.2	1720	1460	1300	1300	1300	1240	7.3	7.9	2000	4000	100	4B	3400	
	50.4	2460	2140	1900	1730	1580	1280	8.4	8.0	2000	4000	100	4B	3400	
	62.9	2000	2000	1830	1730	1580	1280	7.0	7.3	2000	4000	50	4A	3400	
	68.2	1720	1460	1300	1300	1300	1240	4.8	7.1	2000	4000	50	4A	3400	
	78.7	1600	1600	1600	1600	1530	1280	5.8	7.0	2000	4000	50	4A	3400	
	85.2	1720	1460	1300	1300	1300	1240	4.0	6.6	2000	4000	50	4A	3400	
	106	1720	1460	1300	1300	1300	1240	3.3	6.3	2000	4000	50	4A	3400	
	133	1150	1150	1150	1150	1150	940	2.0	5.8	2000	4000	50	4A	3400	
	R4	106	2460	2140	1900	1730	1580	1280	4.5	6.3	2000	4000	50	4A	3400
		130	2460	2140	1900	1730	1580	1280	3.6	6.3	2000	4000	50	4A	3400
143		1720	1460	1300	1300	1300	1240	2.7	5.8	2000	4000	50	4A	3400	
159		2460	2140	1900	1730	1580	1280	3.0	6.3	2000	4000	50	4A	3400	





301 R  264

2060 Nm

	i	M _{n2} [Nm]						P ₁	P _{TB}	n ₁	n _{1max}	M _b		M _{2max}
		n _{2-h} 10000	n _{2-h} 25000	n _{2-h} 50000	n _{2-h} 100000	n _{2-h} 500000	n _{2-h} 1000000							
R4	175	2460	2140	1900	1730	1580	1280	2.7	5.9	2000	4000	50	4A	3400
	215	2460	2140	1900	1730	1580	1280	2.2	5.8	2000	4000	50	4A	3400
	237	1720	1460	1300	1300	1300	1240	1.7	5.3	2000	4000	50	4A	3400
	268	2460	2140	1900	1730	1580	1280	1.8	5.5	2000	4000	50	4A	3400
	291	2460	2140	1900	1730	1580	1280	1.6	5.3	2000	4000	50	4A	3400
	363	2460	2140	1900	1730	1580	1280	1.3	5.0	2000	4000	50	4A	3400
	394	1720	1460	1300	1300	1300	1240	1.0	4.9	2000	4000	50	4A	3400
	453	2000	2000	1830	1730	1580	1280	1.0	4.7	2000	4000	50	4A	3400
	491	1720	1460	1300	1300	1300	1240	0.82	4.7	2000	4000	50	4A	3400
	613	1720	1460	1300	1300	1300	1240	0.66	4.4	2000	4000	50	4A	3400
	766	1720	1460	1300	1300	1300	1240	0.52	4.3	2000	4000	50	4A	3400

303 R  274

2970 Nm

	i	M _{n2} [Nm]						P ₁	P _{TB}	n ₁	n _{1max}	M _b		M _{2max}
		n _{2-h} 10000	n _{2-h} 25000	n _{2-h} 50000	n _{2-h} 100000	n _{2-h} 500000	n _{2-h} 1000000							
R2	9.23	2410	2310	2310	2310	2310	1940	35	18.1	1800	3800	330	4H	5200
	10.9	2970	2810	2810	2650	2570	2090	35	18.3	1800	3800	330	4H	5200
	13.7	2850	2520	2230	2200	2140	2030	32	16.3	1800	3800	260	4F	5200
	15.9	2440	2080	1840	1820	1820	1820	23	14.4	1800	3800	260	4F	5200
	19.2	2000	1750	1650	1650	1650	1500	17.2	13.1	1800	3800	160	4D	5200
	24.8	1050	900	860	860	860	860	7.0	11.2	1800	3800	160	4D	5200
R3	25.7	2410	2310	2310	2310	2130	1730	15.0	10.6	2.000	4.000	160	4D	5200
	31.5	2410	2310	2310	2310	2100	1700	15.0	10.6	2.000	4.000	100	4B	5200
	37.1	2970	2810	2810	2650	2350	1910	15.0	10.7	2.000	4.000	100	4B	5200
	42.6	2410	2210	2210	2210	2030	1650	11.6	9.3	2.000	4.000	100	4B	5200
	46.6	2850	2520	2230	2200	2140	2030	11.2	10.0	2.000	4.000	100	4B	5200
	50.3	2770	2700	2650	2620	2280	1850	12.2	9.3	2.000	4.000	100	4B	5200
	54.2	2440	2080	1840	1820	1820	1820	8.1	9.2	2.000	4.000	100	4B	5200
	63.1	2850	2520	2230	2200	2140	2030	8.7	8.8	2.000	4.000	100	4B	5200
	73.3	2440	2080	1840	1820	1820	1820	6.2	8.2	2.000	4.000	50	4A	5200
	78.7	2850	2450	2230	2200	2140	2030	7.1	8.0	2.000	4.000	50	4A	5200
	91.5	2440	2080	1840	1820	1820	1820	5.2	7.5	2.000	4.000	50	4A	5200
	114	2300	2080	1840	1820	1820	1820	4.3	7.2	2.000	4.000	50	4A	5200
	R4	129	2970	2810	2810	2650	2390	1940	5.1	7.2	2.000	4.000	50	4A
148		2410	2310	2310	2310	2130	1730	3.6	6.5	2.000	4.000	50	4A	5200
158		2970	2810	2810	2650	2350	1910	4.3	7.1	2.000	4.000	50	4A	5200
185		2410	2310	2310	2310	2130	1730	2.9	6.1	2.000	4.000	50	4A	5200
214		2970	2810	2810	2650	2350	1910	3.2	6.5	2.000	4.000	50	4A	5200
231		2440	2080	1840	1820	1820	1820	2.4	6.3	2.000	4.000	50	4A	5200
255		2440	2080	1840	1820	1820	1820	2.1	5.9	2.000	4.000	50	4A	5200
290		2770	2700	2650	2620	2280	1850	2.2	5.9	2.000	4.000	50	4A	5200
313		2440	2080	1840	1820	1820	1820	1.7	5.9	2.000	4.000	50	4A	5200
336		2850	2520	2230	2200	2140	2030	2.0	5.8	2.000	4.000	50	4A	5200
364		2850	2520	2230	2200	2140	2030	1.9	5.7	2.000	4.000	50	4A	5200
390		2440	2080	1840	1820	1820	1820	1.4	5.5	2.000	4.000	50	4A	5200
452		2250	2250	2250	2250	1830	1800	1.2	5.2	2.000	4.000	50	4A	5200
528		2440	2080	1840	1820	1820	1820	1.0	5.1	2.000	4.000	50	4A	5200
567		2850	2450	2230	2200	2140	2030	1.2	5.0	2.000	4.000	50	4A	5200
659		2440	2080	1840	1820	1820	1820	0.83	4.7	2.000	4.000	50	4A	5200
797		2000	1750	1650	1650	1650	1500	0.59	4.6	2.000	4.000	50	4A	5200
824	2440	2080	1840	1820	1820	1820	0.66	4.6	2.000	4.000	50	4A	5200	



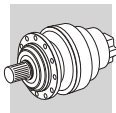

304 R



286

3960 Nm

i	1:	M _{n2} [Nm]						P ₁ [kW]	P _{TB} [kW]	n ₁ [min ⁻¹]	n _{1max} [min ⁻¹]	M _b [Nm]	M _{2max} [Nm]	
		n _{2-h} 10000	n _{2-h} 25000	n _{2-h} 50000	n _{2-h} 100000	n _{2-h} 500000	n _{2-h} 1000000							
R2	9.23	3710	3520	3500	3220	2390	1940	35	18.0	1800	3800	330	4H	6600
	10.9	3960	3750	3690	3540	2680	2180	35	18.6	1800	3800	330	4H	6600
	13.7	3740	3190	2850	2850	2850	2560	35	16.7	1800	3800	260	4F	6600
	16.8	3000	2560	2390	2390	2390	2390	28	13.8	1800	3800	260	4F	6600
R3	25.7	3710	3520	3500	3440	3080	2830	15.0	10.8	2.000	4.000	160	4D	7300
	31.5	3710	3520	3500	3440	3080	2830	15.0	10.9	2.000	4.000	100	4B	7300
	37.1	3960	3750	3690	3540	3430	2780	15.0	11.0	2.000	4.000	100	4B	7300
	42.6	3710	3520	3500	3440	3120	2830	15.0	9.7	2.000	4.000	100	4B	7300
	46.6	3740	3190	2850	2850	2850	2710	14.2	10.3	2.000	4.000	100	4B	7300
	50.3	3960	3750	3690	3540	3430	2780	15.0	9.8	2.000	4.000	100	4B	7300
	63.1	3740	3190	2850	2850	2850	2710	10.9	9.2	2.000	4.000	100	4B	7300
	78.7	3740	3190	2850	2850	2850	2710	9.0	8.5	2.000	4.000	100	4B	7300
	97.0	3010	2560	2390	2390	2390	2390	5.9	7.6	2.000	4.000	50	4A	7300
	121	3010	2560	2390	2390	2390	2390	4.9	7.4	2.000	4.000	50	4A	7300
R4	89.4	3710	3520	3500	3440	3120	2830	9.4	7.4	2.000	4.000	50	4A	7300
	109	3710	3520	3500	3440	3120	2830	7.8	7.4	2.000	4.000	50	4A	7300
	129	3960	3750	3690	3540	3430	2780	7.1	7.5	2.000	4.000	50	4A	7300
	148	3710	3520	3500	3440	3120	2830	5.9	6.7	2.000	4.000	50	4A	7300
	158	3960	3750	3690	3540	3430	2780	5.9	7.5	2.000	4.000	50	4A	7300
	185	3710	3520	3500	3440	3080	2830	4.7	6.2	2.000	4.000	50	4A	7300
	214	3960	3750	3690	3540	3430	2780	4.4	6.8	2.000	4.000	50	4A	7300
	227	3710	3520	3500	3440	3120	2830	3.9	6.3	2.000	4.000	50	4A	7300
	267	3960	3750	3690	3540	3430	2780	3.5	6.3	2.000	4.000	50	4A	7300
	290	3960	3750	3690	3540	3430	2780	3.2	6.2	2.000	4.000	50	4A	7300
	307	3710	3520	3500	3440	3120	2830	2.9	5.8	2.000	4.000	50	4A	7300
	338	3010	2560	2390	2390	2390	2390	1.9	5.6	2.000	4.000	50	4A	7300
	364	3740	3190	2850	2850	2850	2710	2.3	5.9	2.000	4.000	50	4A	7300
	414	3010	2560	2390	2390	2390	2390	1.6	5.5	2.000	4.000	50	4A	7300
	452	3960	3710	3660	3540	3430	2780	2.1	5.4	2.000	4.000	50	4A	7300
	560	3010	2560	2390	2390	2390	2390	1.2	5.1	2.000	4.000	50	4A	7300
699	3010	2560	2390	2390	2390	2390	0.93	4.9	2.000	4.000	50	4A	7300	

305 R



298

5600 Nm

i	1:	M _{n2} [Nm]						P ₁ [kW]	P _{TB} [kW]	n ₁ [min ⁻¹]	n _{1max} [min ⁻¹]	M _b [Nm]	M _{2max} [Nm]	
		n _{2-h} 10000	n _{2-h} 25000	n _{2-h} 50000	n _{2-h} 100000	n _{2-h} 500000	n _{2-h} 1000000							
R2	9.23	4650	4050	4000	3870	2390	1940	35	17.8	1800	3800	440	4L	7700
	10.9	5300	4720	4720	4350	2680	2180	35	18.5	1800	3800	440	4L	7700
	13.7	5600	5040	4470	4280	3150	2560	35	17.0	1800	3800	440	4L	7700
	15.9	4690	4000	3600	3600	3500	2840	35	15.1	1800	3800	330	4H	7700
	19.2	3800	3300	3100	3100	3000	2790	32	14.0	1800	3800	260	4F	7700
R3	25.7	4680	4490	4490	4490	3800	3090	15.0	10.9	2000	4000	260	4F	8800
	31.5	4700	4490	4490	4490	3750	3040	15.0	11.2	2000	4000	260	4F	8800
	37.1	5800	5500	5480	5300	4210	3420	15.0	11.3	2000	4000	260	4F	8800
	42.6	4700	4450	4430	4430	3630	2950	15.0	10.0	2000	4000	160	4D	8800
	46.6	5600	5040	4470	4400	4280	3490	15.0	10.6	2000	4000	160	4D	8800
	50.3	5530	5350	5300	5230	4070	3310	15.0	10.0	2000	4000	160	4D	8800
	54.2	4690	4000	3600	3600	3550	3460	15.0	9.8	2000	4000	100	4B	8800
	63.1	5600	5040	4470	4400	4280	3490	15.0	9.4	2000	4000	100	4B	8800
	73.3	4690	4000	3600	3600	3550	3460	12.3	8.8	2000	4000	100	4B	8800
	78.7	5600	4900	4470	4400	4280	3490	14.3	8.7	2000	4000	100	4B	8800
	91.5	4690	4000	3600	3600	3550	3460	10.2	8.1	2000	4000	100	4B	8800
114	4430	4000	3600	3600	3500	3460	8.6	7.9	2000	4000	50	4A	8800	
R4	129	5800	5480	5480	5300	4270	3470	10.3	7.6	2000	4000	50	4A	8800
	148	4700	4490	4490	4490	3800	3090	7.4	6.9	2000	4000	50	4A	8800
	158	5800	5500	5480	5300	4210	3420	8.6	7.6	2000	4000	50	4A	8800

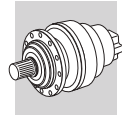

305 R  298

5600 Nm

	i	M _{n2} [Nm]						P ₁	P _{TB}	n ₁	n _{1max}	M _b		M _{2max}
		n _{2-h} 10000	n _{2-h} 25000	n _{2-h} 50000	n _{2-h} 100000	n _{2-h} 500000	n _{2-h} 1000000							
R4	185	4700	4490	4490	4490	3800	3090	6.0	6.4	2000	4000	50	4A	8800
	214	5800	5500	5480	5300	4210	3420	6.4	6.9	2000	4000	50	4A	8800
	231	4690	4000	3600	3600	3550	3460	4.7	6.8	2000	4000	50	4A	8800
	255	4690	4000	3600	3600	3550	3460	4.3	6.3	2000	4000	50	4A	8800
	290	5530	5400	5300	5230	4070	3310	4.5	6.3	2000	4000	50	4A	8800
	313	4690	4000	3600	3600	3550	3460	3.5	6.2	2000	4000	50	4A	8800
	336	5600	5040	4470	4400	4280	3490	3.9	6.1	2000	4000	50	4A	8800
	364	5600	5040	4470	4400	4280	3490	3.6	6.0	2000	4000	50	4A	8800
	390	4690	4000	3600	3600	3550	3460	2.8	5.8	2000	4000	50	4A	8800
	452	4750	4750	4750	4750	3660	3210	2.5	5.5	2000	4000	50	4A	8800
	528	4690	4000	3600	3600	3550	3460	2.1	5.4	2000	4000	50	4A	8800
	567	5600	4900	4470	4400	4280	3490	2.3	5.3	2000	4000	50	4A	8800
	659	4690	4000	3600	3600	3550	3460	1.7	5.0	2000	4000	50	4A	8800
	797	3800	3300	3100	3100	3000	2790	1.1	4.8	2000	4000	50	4A	8800
	824	4690	4000	3600	3600	3550	3460	1.3	4.8	2000	4000	50	4A	8800

306 R  310

7300 Nm

	i	M _{n2} [Nm]						P ₁	P _{TB}	n ₁	n _{1max}	M _b		M _{2max}
		n _{2-h} 10000	n _{2-h} 25000	n _{2-h} 50000	n _{2-h} 100000	n _{2-h} 500000	n _{2-h} 1000000							
R2	9.23	4650	4050	4000	3870	2390	1940	35	18.8	1800	3800	440	4L	12000
	10.9	5300	4720	4720	4350	2680	2180	35	19.9	1800	3800	440	4L	12000
	13.7	6500	5920	5920	5100	3150	2560	35	18.2	1800	3800	440	4L	12000
	15.9	7300	6890	6530	5670	3500	2840	35	16.3	1800	3800	440	4L	12000
	19.2	7000	5900	5500	5400	3990	3240	35	15.2	1800	3800	400	4K	12000
R3	33.2	8020	8020	8020	8020	5680	4620	35	14.3	2000	4000	260	4F	14900
	39.2	9770	9340	9340	9300	6110	4960	35	14.6	2000	4000	260	4F	14900
	46.3	10420	9850	9850	9600	6860	5570	35	14.8	2000	4000	260	4F	14900
	58.1	9560	9100	9100	9100	6680	5430	35	13.6	2000	4000	260	4F	14900
	67.5	7890	7590	7590	7590	6620	5380	25	12.4	2000	4000	260	4F	14900
	72.9	10080	9350	8300	7950	6810	5530	27	12.7	2000	4000	160	4D	14900
	84.7	9540	9350	8300	7950	6810	5530	23	11.6	2000	4000	160	4D	14900
	98.5	8630	7370	6530	6500	6460	5480	17.7	10.8	2000	4000	100	4B	14900
	119	8500	7370	6530	6500	6460	5480	15.2	10.1	2000	4000	100	4B	14900
	144	7000	5900	5500	5500	5040	5040	10.7	9.7	2000	4000	100	4B	14900
R4	158	10420	9850	9850	9600	6860	5570	14.9	9.9	2000	4000	100	4B	14900
	168	8320	7700	7700	7530	5950	4830	11.3	9.3	2000	4000	100	4B	14900
	181	9450	9450	9450	9450	6970	5660	11.6	8.9	2000	4000	100	4B	14900
	214	10420	9850	9850	9600	6860	5570	11.1	8.9	2000	4000	50	4A	14900
	230	7890	7590	7590	7590	6620	5380	7.7	8.8	2000	4000	50	4A	14900
	249	10080	9350	8300	7950	6810	5530	9.0	8.9	2000	4000	50	4A	14900
	289	9540	9350	8300	7950	6810	5530	7.6	8.3	2000	4000	50	4A	14900
	312	7890	7590	7590	7590	6620	5380	5.7	7.9	2000	4000	50	4A	14900
	389	8500	7590	7590	7590	6620	5380	5.2	7.3	2000	4000	50	4A	14900
	420	10080	9350	8300	7950	6810	5530	5.4	7.4	2000	4000	50	4A	14900
	455	8630	7370	6530	6500	6460	5480	4.4	7.2	2000	4000	50	4A	14900
	488	9540	9350	8300	7950	6810	5530	4.5	7.0	2000	4000	50	4A	14900
	550	8500	7370	6530	6500	6460	5480	3.7	6.8	2000	4000	50	4A	14900
	590	9500	8500	7800	7800	6810	5530	3.8	6.7	2000	4000	50	4A	14900
	665	7000	5900	5500	5500	5040	5040	2.5	6.5	2000	4000	50	4A	14900
830	7000	5900	5500	5500	5040	5040	2.0	6.1	2000	4000	50	4A	14900	



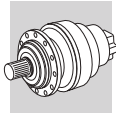

307 R



322

14000 Nm

i	1:	M _{n2} [Nm]						P ₁ [kW]	P _{TB} [kW]	n ₁ [min ⁻¹]	n _{1max} [min ⁻¹]	M _b [Nm]	M _{2max} [Nm]	
		n _{2-h} 10000	n _{2-h} 25000	n _{2-h} 50000	n _{2-h} 100000	n _{2-h} 500000	n _{2-h} 1000000							
R2	13.0	9000	8500	8270	7960	6570	5340	85	*	1800	3800	1000	5K	18600
	15.5	11400	10690	9630	9520	7440	6040	85	*	1800	3800	1000	5K	21000
	19.8	14000	12700	11300	10790	8850	7190	85	*	1800	3800	800	5G	21000
	23.5	11000	9600	8700	8700	8240	7490	74	*	1800	3800	500	5C	21000
R3	31.6	9000	9000	9000	8300	5490	4460	35	17.3	2000	4000	400	4K	18600
	37.7	15680	14890	12400	10070	6210	5050	35	16.6	2000	4000	440	4L	21000
	44.6	15680	14890	13930	11310	6980	5670	35	16.8	2000	4000	400	4K	21000
	55.9	15680	14890	14890	13260	8180	6650	35	15.8	2000	4000	330	4H	21000
	65.0	14670	14010	14010	13510	9090	7380	35	14.6	2000	4000	260	4F	21000
	71.8	14840	12700	11300	10790	9340	7590	35	15.2	2000	4000	260	4F	21000
	78.6	12300	12300	12300	12300	9560	7770	35	13.8	2000	4000	260	4F	21000
	83.4	14840	12700	11300	10790	9340	7590	33	14.1	2000	4000	260	4F	21000
	99.0	11000	9600	8700	8700	8240	7490	23	13.1	2000	4000	160	4D	21000
	120	11000	9600	8700	8700	8240	7490	19.9	12.4	2000	4000	160	4D	21000
	R4	152	15680	14890	14890	13510	9560	7770	15.0	11.9	2000	4000	100	4B
165		14840	12700	11300	10790	9340	7590	15.0	11.5	2000	4000	100	4B	21000
191		15680	14890	14890	13510	9560	7770	15.0	11.2	2000	4000	100	4B	21000
206		15680	14890	14890	13510	9560	7770	15.0	10.8	2000	4000	100	4B	21000
232		14840	12700	11300	10790	9340	7590	14.3	10.3	2000	4000	100	4B	21000
258		15680	14890	14890	13510	9560	7770	13.8	10.2	2000	4000	100	4B	21000
284		14840	12700	11300	10790	9340	7590	11.6	10.2	2000	4000	100	4B	21000
300		15000	14010	14010	13510	9560	7770	11.8	9.6	2000	4000	100	4B	21000
331		14840	12700	11300	10790	9340	7590	10.0	9.9	2000	4000	50	4A	21000
363		12300	12300	12300	12300	9560	7770	8.0	9.1	2000	4000	50	4A	21000
413		14840	12700	11300	10790	9340	7590	8.0	9.3	2000	4000	50	4A	21000
453		15000	13800	12900	12500	9560	7770	7.8	8.5	2000	4000	50	4A	21000
490		11000	9600	8700	8700	8240	7490	5.3	8.7	2000	4000	50	4A	21000
581		14330	12710	11300	10790	9340	7590	5.7	8.3	2000	4000	50	4A	21000
690	11000	9600	8700	8700	8240	7490	3.8	7.9	2000	4000	50	4A	21000	

309 R



334

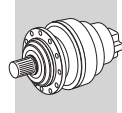

16460 Nm

i	1:	M _{n2} [Nm]						P ₁ [kW]	P _{TB} [kW]	n ₁ [min ⁻¹]	n _{1max} [min ⁻¹]	M _b [Nm]	M _{2max} [Nm]	
		n _{2-h} 10000	n _{2-h} 25000	n _{2-h} 50000	n _{2-h} 100000	n _{2-h} 500000	n _{2-h} 1000000							
R2	13.0	9800	9120	8270	7960	6570	5340	85	*	1800	3800	1000	5K	27400
	15.5	11400	10690	9630	9520	7440	6040	85	*	1800	3800	1000	5K	27400
	19.8	14000	13270	12270	12270	8850	7190	85	*	1800	3800	1000	5K	27400
	23.5	16460	14070	12500	12370	9980	8110	85	*	1800	3800	800	5G	27400
R3	31.6	12800	12310	10960	8900	5490	4460	35	23.7	2000	4000	440	4L	27900
	37.7	15830	15260	12400	10070	6210	5050	35	23.0	2000	4000	440	4L	29000
	44.6	18670	17150	13930	11310	6980	5670	35	23.3	2000	4000	400	4K	29000
	55.9	18510	17140	16330	13260	8180	6650	35	21.8	2000	4000	400	4K	29000
	65.0	14670	14300	14300	14010	9090	7380	35	19.9	2000	4000	260	4F	29000
	71.8	21980	19060	16940	15790	9740	7910	35	21.0	2000	4000	330	4H	29000
	83.4	18300	18100	16940	16190	10830	8790	35	19.3	2000	4000	260	4F	29000
	99.0	17000	14400	13000	13000	12210	9910	35	18.0	2000	4000	260	4F	29000
	120	17000	14400	13000	13000	12370	10280	30	16.9	2000	4000	160	4D	29000
	R4	152	21620	21260	21260	18580	11460	9310	15.0	15.8	2000	4000	160	4D
165		21980	19060	16940	16190	12810	10410	15.0	15.4	2000	4000	160	4D	29000
191		18510	17500	17500	17140	11160	9070	15.0	14.9	2000	4000	160	4D	29000
206		21620	21260	21260	18580	11460	9310	15.0	14.2	2000	4000	160	4D	29000
232		18300	18100	16940	16190	12810	10410	15.0	13.7	2000	4000	100	4B	29000
258		18510	17500	17500	17140	11160	9070	15.0	13.4	2000	4000	100	4B	29000
284		18300	18100	16940	16190	12810	10410	15.0	13.6	2000	4000	100	4B	29000
331		21980	19060	16940	16190	12810	10410	15.0	13.1	2000	4000	100	4B	29000
374		14670	14300	14300	14010	11060	8990	9.2	11.7	2000	4000	100	4B	29000





309 R  334

16460 Nm

	i	M _{n2} [Nm]						P ₁	P _{TB}	n ₁	n _{1max}	M _b		M _{2max}
		n _{2-h} 10000	n _{2-h} 25000	n _{2-h} 50000	n _{2-h} 100000	n _{2-h} 500000	n _{2-h} 1000000							
R4	413	21980	19060	16940	16190	12810	10410	12.0	12.1	2000	4000	100	4B	29000
	457	17000	14400	13000	13000	12370	10280	8.8	11.7	2000	4000	50	4A	29000
	490	17000	14400	13000	13000	12370	10280	8.2	11.5	2000	4000	50	4A	29000
	581	15800	15800	15800	15000	12810	10410	6.4	10.9	2000	4000	50	4A	29000
	690	17000	14400	13000	13000	12370	10280	5.8	10.4	2000	4000	50	4A	29000



310M R  346

33640 Nm

	i	M _{n2} [Nm]						P ₁	P _{TB}	n ₁	n _{1max}	M _b		M _{2max}
		n _{2-h} 10000	n _{2-h} 25000	n _{2-h} 50000	n _{2-h} 100000	n _{2-h} 500000	n _{2-h} 1000000							
R2	12.0	24880	24320	24320	24320	15600	12670	130	*	1500	2500	3300	6L	47600
	15.4	30110	25640	22700	21660	18580	15090	130	*	1500	2500	2750	6K	47600
	18.3	23930	20350	18000	17810	17810	16620	130	*	1500	2500	2200	6G	47600
	16.6	33640	31900	29360	26500	17870	14510	130	*	1500	2500	2750	6K	47600
	21.3	30110	25640	22700	21660	20710	16820	130	*	1500	2500	2750	6K	47600
	25.3	23930	20350	18000	17810	17810	16620	118	*	1500	2500	2200	6G	47600
R3	37.7	15800	14860	12070	9800	6050	4910	35	27.7	1800	3800	440	4L	47600
	44.6	18640	16690	13550	11010	6790	5520	35	28.4	1800	3800	440	4L	47600
	55.9	23360	19570	15890	12910	7960	6470	35	26.6	1800	3800	440	4L	47600
	65.0	26060	21740	17660	14340	8850	7190	35	24.6	1800	3800	440	4L	47600
	71.8	29930	23300	18920	15370	9480	7700	35	25.4	1800	3800	440	4L	47600
	78.6	19480	19330	19330	16390	10110	8210	35	23.2	1800	3800	330	4H	47600
	83.4	30110	25640	21030	17080	10540	8560	35	23.6	1800	3800	400	4K	47600
	99.0	23930	20350	18000	17810	11880	9650	35	21.4	1800	3800	330	4H	47600
	120	23930	20350	18000	17810	13580	11030	35	20.4	1800	3800	260	4F	47600
	R4	136	30730	30730	28700	23310	14380	11680	35	20.0	2000	4000	260	4F
160		33640	31900	29360	25750	15890	12910	35	20.9	2000	4000	260	4F	47600
189		33640	31900	29360	26500	17850	14500	35	21.0	2000	4000	260	4F	47600
206		30110	25640	22700	21660	18920	15370	35	20.1	2000	4000	260	4F	47600
238		33640	31900	29360	26500	17380	14110	33	19.6	2000	4000	160	4D	47600
258		30110	25640	22700	21660	18420	14960	28	18.8	2000	4000	160	4D	47600
276		28060	28070	28070	26500	17220	13990	24	18.2	2000	4000	160	4D	47600
305		30110	25640	22700	21660	20710	16820	23	18.9	2000	4000	160	4D	47600
347		33170	30650	29360	26500	17700	14380	22.6	17.2	2000	4000	160	4D	47600
383		30110	25640	22700	21660	20710	16820	18.6	17.7	2000	4000	100	4B	47600
454		23930	20350	18000	17810	17810	16620	12.5	16.3	2000	4000	100	4B	47600
517		30110	25640	22700	21660	20710	16820	13.8	15.6	2000	4000	100	4B	47600
590		19480	19330	19330	19330	17120	13900	7.8	14.6	2000	4000	50	4A	47600
639		23930	20350	18000	17810	17810	16620	8.9	14.5	2000	4000	50	4A	47600
757	24820	24820	22700	21660	20380	16550	7.8	14.1	2000	4000	50	4A	47600	
898	23930	20350	18000	17810	17810	16620	6.3	13.2	2000	4000	50	4A	47600	

311M R  358

49210 Nm

	i	M _{n2} [Nm]						P ₁	P _{TB}	n ₁	n _{1max}	M _b		M _{2max}
		n _{2-h} 10000	n _{2-h} 25000	n _{2-h} 50000	n _{2-h} 100000	n _{2-h} 500000	n _{2-h} 1000000							
R2	12.0	24880	24320	24320	24320	15600	12670	150	*	1500	2500	3300	6L	58300
	15.4	31190	31190	31190	30110	18580	15090	150	*	1500	2500	3300	6L	58300
	18.3	36470	31040	27480	27190	20950	17020	150	*	1500	2500	2750	6K	58300
	16.6	45390	43900	35650	28960	17870	14510	150	*	1500	2500	3300	6L	58300
	21.3	47810	41400	36690	34490	21280	17280	150	*	1500	2500	2750	6K	58300
	25.3	36470	31040	27480	27190	23990	19490	150	*	1500	2500	2200	6G	58300



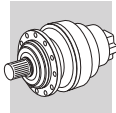

311M R



358

49210 Nm

	i	M _{n2} [Nm]						P ₁	P _{TB}	n ₁	n _{1max}	M _b		M _{2max}
		n _{2-h} 10000	n _{2-h} 25000	n _{2-h} 50000	n _{2-h} 100000	n _{2-h} 500000	n _{2-h} 1000000							
R3	53.0	32410	32420	32420	27690	17090	13880	85	24.0	2000	4000	800	5G	58300
	63.2	41360	39670	38580	31340	19340	15710	85	23.5	2000	4000	800	5G	58300
	68.0	41500	41400	36690	32980	20350	16530	85	23.4	2000	4000	800	5G	58300
	81.1	47810	41400	36690	35010	23030	18700	85	22.7	2000	4000	800	5G	58300
	96.3	33520	32020	32020	32020	23990	19490	77	21.8	2000	4000	500	5C	58300
	104	47810	41400	36690	35010	27420	22270	85	22.3	2000	4000	500	5C	58300
	124	41250	41170	36690	35010	28570	23200	77	21.1	2000	4000	400	5B	58300
	147	36470	31040	27480	27190	27190	23670	55	20.2	2000	4000	400	5B	58300
R4	154	49210	38650	31380	25490	15730	12780	35	23.8	2000	4000	440	4L	58300
	182	49210	43410	35250	28630	17670	14350	35	23.8	2000	4000	330	4H	58300
	198	47810	41400	36690	30360	18730	15220	35	22.8	2000	4000	260	4F	58300
	229	49210	46590	41340	33570	20710	16830	35	22.5	2000	4000	260	4F	58300
	266	49210	46590	45450	37310	23010	18700	35	21.0	2000	4000	260	4F	58300
	294	47810	41400	36690	35010	24670	20040	35	21.6	2000	4000	160	4D	58300
	341	47810	41400	36690	35010	27410	22260	33	20.3	2000	4000	160	4D	58300
	413	47810	41400	36690	35010	29500	23960	27	19.2	2000	4000	160	4D	58300
	438	47810	41400	36690	35010	28930	23490	26	19.6	2000	4000	100	4D	58300
	490	33520	32020	32020	32020	23990	19490	16.2	18.1	2000	4000	100	4B	58300
	520	41250	41170	36690	35010	28570	23200	18.8	18.5	2000	4000	100	4B	58300
	629	41250	41170	36690	35010	28570	23200	15.5	17.5	2000	4000	100	4B	58300
	746	36470	31040	27480	27190	27190	23670	11.6	16.8	2000	4000	100	4B	58300

313M R



370

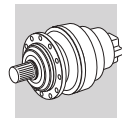

60940 Nm

	i	M _{n2} [Nm]						P ₁	P _{TB}	n ₁	n _{1max}	M _b		M _{2max}
		n _{2-h} 10000	n _{2-h} 25000	n _{2-h} 50000	n _{2-h} 100000	n _{2-h} 500000	n _{2-h} 1000000							
R2	12.2	25160	24620	24620	24620	15740	12790	150	*	1500	2500	3300	6L	86300
	15.9	32070	32070	32070	30710	18950	15390	150	*	1500	2500	3300	6L	86300
	19.1	38580	34160	30260	30200	21580	17530	150	*	1500	2500	3300	6L	86300
	16.8	45900	44290	35970	29210	18030	14640	150	*	1500	2500	3300	6L	105000
	22.0	57130	48700	43150	35170	21700	17630	150	*	1500	2500	3300	6L	105000
	26.4	40100	34160	30260	30200	24710	20070	150	*	1500	2500	2750	6K	105000
R3	53.7	35830	33520	33520	27940	17240	14000	85	28.9	1800	3800	800	5G	105000
	64.0	41820	40180	38930	31620	19510	15850	85	28.6	1800	3800	800	5G	105000
	69.9	45180	44000	41410	33630	20750	16860	85	27.2	1800	3800	800	5G	105000
	82.2	52030	51920	46350	37650	23230	18870	85	28.2	1800	3800	800	5G	105000
	97.5	50810	48640	48640	42450	26190	21270	85	26.7	1800	3800	630	5E	105000
	107	57130	48700	43150	41440	27970	22720	85	26.3	1800	3800	630	5E	105000
	127	57130	48700	43150	41440	31530	25610	85	24.9	1800	3800	500	5C	105000
	153	40100	34160	30260	30200	30200	29160	53	23.9	1800	3800	400	5B	105000
R4	185	57650	43780	35560	28890	17820	14480	35	29.1	2000	4000	400	4K	105000
	201	60940	46420	37700	30630	18900	15350	35	28.0	2000	4000	400	4K	105000
	237	60940	52150	42350	34400	21230	17240	35	28.0	2000	4000	260	4F	105000
	281	50810	48640	47760	38780	23930	19440	35	26.1	2000	4000	260	4F	105000
	309	57130	48700	43150	41420	25550	20760	35	26.0	2000	4000	260	4F	105000
	346	60940	57660	55180	44810	27650	22460	35	24.4	2000	4000	260	4F	105000
	387	57130	48700	43150	41440	29970	24340	35	24.4	2000	4000	160	4D	105000
	450	57130	48700	43150	41440	33300	27040	30	22.9	2000	4000	160	4D	105000
	496	50810	48640	48640	48640	33200	26970	24	21.6	2000	4000	160	4D	105000
	535	57130	48700	43150	41440	37540	30490	25	21.6	2000	4000	160	4D	105000
	647	57130	48700	43150	41440	39970	32460	21	20.4	2000	4000	100	4B	105000
	778	40100	34160	30260	30200	30200	30200	12.2	19.6	2000	4000	100	4B	105000





314M R  382

80640 Nm

	i	M _{n2} [Nm]						P ₁	P _{TB}	n ₁	n _{1max}	M _b		M _{2max}
		n _{2-h} 10000	n _{2-h} 25000	n _{2-h} 50000	n _{2-h} 100000	n _{2-h} 500000	n _{2-h} 1000000							
R3	51.1	79616	75696	66528	54032	33344	27080	130	42	1500	2500	2200	6G	115000
	65.5	78024	72432	72432	64352	39704	32248	130	42	1500	2500	2200	6G	115000
	77.8	61848	59496	59488	59488	43712	35504	130	39	1500	2500	2200	6G	115000
	82.3	73312	67496	62304	59720	46544	37808	130	40	1500	2500	2200	6G	115000
	97.6	73304	67496	62304	59720	51240	41616	126	37	1500	2500	2200	6G	115000
	113	63256	54024	47944	47400	47400	41792	93	36	1500	2500	2200	6G	115000
	70.7	80640	75696	75696	61888	38176	31016	130	42	1500	2500	2200	6G	115000
	90.7	78016	72432	72432	71136	44248	35936	130	41	1500	2500	3300	6L	115000
	108	61848	59496	59488	59488	43712	35504	98	37	1500	2500	2750	6K	115000
	114	73312	67496	62304	59720	51864	42128	109	38	1500	2500	2750	6K	115000
	135	73304	67496	62304	59720	51240	41616	93	35	1500	2500	2200	6G	115000
	157	63256	54024	47944	47400	47400	41792	69	35	1500	2500	2200	6G	115000
	R4	160	52250	39680	32230	26180	16160	13120	35	45	1800	3800	440	4L
189		58690	44570	36200	29410	18150	14740	35	45	1800	3800	440	4L	115000
238		68810	52250	42440	34470	21270	17280	35	42	1800	3800	400	4K	115000
276		76460	58060	47160	38310	23640	19200	35	39	1800	3800	400	4K	115000
354		91050	69130	56160	45620	28150	22870	35	37	1800	3800	400	4K	115000
421		77310	74370	63340	51430	31730	25780	31	34	1800	3800	330	4H	115000
445		73312	64864	52664	42784	26400	21448	35	35	1800	3800	400	4K	115000
528		73312	67496	59400	48232	29760	24176	30	33	1800	3800	330	4H	115000
614		63256	54024	47944	47400	33080	26864	22	32	1800	3800	260	4F	115000

315M R  394

100800 Nm

	i	M _{n2} [Nm]						P ₁	P _{TB}	n ₁	n _{1max}	M _b		M _{2max}
		n _{2-h} 10000	n _{2-h} 25000	n _{2-h} 50000	n _{2-h} 100000	n _{2-h} 500000	n _{2-h} 1000000							
R3	51.1	99510	94620	83160	67540	41680	33850	150	42	1500	2500	2750	6K	135000
	65.5	100800	94620	94620	80440	49630	40310	150	42	1500	2500	2200	6G	135000
	77.8	100800	94620	94620	88920	55960	45450	150	40	1500	2500	2200	6G	135000
	82.3	91640	84370	77880	74650	58180	47260	150	39	1500	2500	1600	6E	135000
	97.6	91640	84370	77880	74650	65060	52850	150	38	1500	2500	1600	6E	135000
	113	79070	67530	59930	59250	59250	52240	116	37	1500	2500	900	6B	135000
	70.7	100800	94620	94620	77360	47720	38770	150	42	1500	2500	2200	6G	135000
	90.7	100800	94620	94620	88920	56840	46170	150	41	1500	2500	1600	6E	135000
	108	100800	94620	94620	88920	64090	52050	150	39	1500	2500	1600	6E	135000
	114	91630	84370	77880	74650	65060	52850	136	38	1500	2500	1200	6C	135000
	135	91630	84370	77880	74650	65060	52850	116	36	1500	2500	1200	6C	135000
	157	79070	67530	59930	59250	59250	52240	87	35	1500	2500	900	6B	135000
	R4	225	100800	94620	91070	73970	45640	37070	90	37	1800	3800	600	5E
269		100800	94620	94620	83700	51650	41950	80	36	1800	3800	500	5C	135000
345		100800	94620	94620	88920	61500	49960	62	35	1800	3800	400	5B	135000
409		100800	94620	94620	88920	64070	52040	52	33	1800	3800	400	5B	135000
525		100800	94620	94620	88920	67360	54720	41	31	1800	3800	400	5B	135000
623		100800	94620	94620	88920	67360	54720	34	30	1800	3800	400	5B	135000
659		91640	84370	77880	74650	65060	52850	30	30	1800	3800	400	5B	135000
782		91640	84370	77880	74650	65060	52850	25	28.9	1800	3800	400	5B	135000
909		79070	67530	59930	59250	59250	52240	18.5	28.4	1800	3800	400	5B	135000



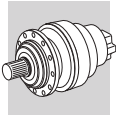

316M R



406

134390 Nm

	i	M _{n2} [Nm]						P ₁	P _{TB}	n ₁	n _{1max}	M _b		M _{2max}
		n _{2-h}	n _{2-h}	n _{2-h}	n _{2-h}	n _{2-h}	n _{2-h}							
	1:	10000	25000	50000	100000	500000	1000000	[kW]	[kW]	[min ⁻¹]	[min ⁻¹]	[Nm]		[Nm]
R3	51.1	99520	99520	83160	67540	41680	33850	150	46	1500	2500	2750	6K	192000
	64.1	122190	111300	97490	79180	48860	39690	150	45	1500	2500	2750	6K	192000
	65.5	127370	121920	99020	80430	49630	40310	150	47	1500	2500	2750	6K	192000
	77.8	118110	113650	111640	90670	55950	45450	150	45	1500	2500	2200	6G	192000
	82.3	122180	111300	99530	94300	58180	47260	150	44	1500	2500	2200	6G	192000
	97.6	122180	111300	99530	99530	65600	53280	150	42	1500	2500	2200	6G	192000
	70.7	134400	117260	95220	77340	47720	38770	150	47	1500	2500	2200	6G	192000
	88.7	122190	111300	99530	90690	55950	45450	150	44	1500	2500	2200	6G	192000
	90.7	134400	126160	113420	92100	56830	46170	150	46	1500	2500	2200	6G	192000
	108	118110	113650	113640	103860	64070	52050	150	43	1500	2500	1600	6E	192000
	114	122190	111300	99530	99530	66640	54120	150	43	1500	2500	1600	6E	192000
	135	122190	111300	99530	99530	75130	61020	150	41	1500	2500	1600	6E	192000
	R4	225	129890	112120	91060	73970	45640	37070	85	40	1800	3800	800	5G
269		134400	126160	103050	83700	51650	41950	85	39	1800	3800	630	5E	192000
289		134400	126160	108440	88080	54350	44150	85	39	1800	3800	630	5E	192000
337		122180	111300	99530	98120	60540	49180	77	37	1800	3800	500	5C	192000
363		122190	111300	99530	99530	63710	51750	72	37	1800	3800	400	5B	192000
430		122190	111300	99530	99530	71830	58340	60	35	1800	3800	400	5B	192000
443		134400	126160	123700	118580	73240	59490	65	36	1800	3800	400	5B	192000
525		134400	126160	123700	118580	76300	61980	54	34	1800	3800	400	5B	192000
623		118110	113650	113640	113640	77820	63210	40	32	1800	3800	400	5B	192000
659		122180	111300	99530	99530	86750	70460	39	32	1800	3800	400	5B	192000
782		122190	111300	99530	99530	86750	70460	33	31	1800	3800	400	5B	192000

317M R



416

207490 Nm

	i	M _{n2} [Nm]						P ₁	P _{TB}	n ₁	n _{1max}	M _b		M _{2max}	
		n _{2-h}	n _{2-h}	n _{2-h}	n _{2-h}	n _{2-h}	n _{2-h}								
	1:	10000	25000	50000	100000	500000	1000000	[kW]	[kW]	[min ⁻¹]	[min ⁻¹]	[Nm]		[Nm]	
R3	49.8	97030	97030	81690	66340	40940	33250	150	47	1500	2500	2750	6K	393000	
	64.9	126120	121070	98330	79870	49280	40030	150	48	1500	2500	2750	6K	393000	
	78.1	125800	121300	111970	90940	56110	45580	150	48	1500	2500	2750	6K	393000	
	83.3	161300	144170	117090	95110	58690	47670	150	47	1500	2500	2750	6K	393000	
	100	155950	155950	133340	108290	66820	54280	150	46	1500	2500	2200	6G	393000	
	119	150260	128480	114130	112960	75340	61190	150	43	1500	2500	1600	6E	393000	
	68.9	151620	115150	93530	75970	46880	38080	150	50	1500	2500	2750	6K	393000	
	89.8	179830	138660	112600	91460	56440	45850	150	48	1500	2500	2750	6K	393000	
	108	125790	121300	121300	104160	64260	52200	150	46	1500	2500	2200	6G	393000	
	115	195640	165120	134080	108910	67200	54600	150	46	1500	2500	2200	6G	393000	
	139	155940	155950	148950	124040	76520	62160	150	44	1500	2500	1600	6E	393000	
	165	150260	128480	114130	112960	86290	70080	150	41	1500	2500	1600	6C	393000	
	R4	220	138860	110130	89450	72660	44830	36420	90	42	1800	3800	800	5G	393000
		262	164050	124620	101220	82220	50730	41210	90	41	1800	3800	800	5G	393000
		336	195360	148400	120540	97910	60410	49070	90	40	1800	3800	800	5G	393000
399		193680	167310	135890	110380	68110	55320	90	38	1800	3800	600	5E	393000	
438		179830	166930	145110	117860	72730	59070	87	38	1800	3800	500	5C	393000	
520		179830	166930	163600	132870	81990	66600	74	36	1800	3800	400	5B	393000	
626		125790	121300	121300	121300	93360	75830	43	34	1800	3800	400	5B	393000	
677		155950	155950	148950	142350	98610	80090	49	35	1800	3800	400	5B	393000	
803		155940	155950	148950	142350	111170	90300	41	33	1800	3800	400	5B	393000	
953		150260	128480	114130	112960	112960	95190	34	32	1800	3800	400	5B	393000	

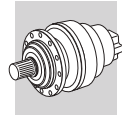

318M R  426

297550 Nm

	i	M _{n2} [Nm]						P ₁	P _{TB}	n ₁	n _{1max}	M _b		M _{2max}
		n _{2-h}	n _{2-h}	n _{2-h}	n _{2-h}	n _{2-h}	n _{2-h}							
	1:	10000	25000	50000	100000	500000	1000000							
R4	225	297550	260540	227590	184830	114050	92650	150	62	1500	2500	1600	6E	500000
	288	297550	260540	231740	220140	135810	110320	150	60	1500	2500	1600	6E	500000
	342	297540	260540	231740	223920	153140	124380	150	58	1500	2500	1200	6C	500000
	362	297550	260540	231740	223920	159240	129330	146	58	1500	2500	1200	6C	500000
	430	297550	260540	231740	223920	160590	130440	123	55	1500	2500	900	6B	500000
	499	264710	256160	231740	223920	160590	130440	94	53	1500	2500	900	6B	500000
	311	297550	260540	231740	211740	130610	106110	150	61	1500	2500	1200	6C	500000
	399	297530	260540	231740	223920	155590	126360	132	58	1500	2500	900	6B	500000
	474	297550	260540	231740	223920	160590	130440	111	55	1500	2500	900	6B	500000
	501	297550	260540	231740	223920	160590	130440	105	55	1500	2500	900	6B	500000
	595	297550	260540	231740	223920	160590	130440	89	53	1500	2500	900	6B	500000
	691	264710	256160	231740	223920	160590	130440	68	50	1500	2500	900	6B	500000

319 R  436

471190 Nm

	i	M _{n2} [Nm]						P ₁	P _{TB}	n ₁	n _{1max}	M _b		M _{2max}
		n _{2-h}	n _{2-h}	n _{2-h}	n _{2-h}	n _{2-h}	n _{2-h}							
	1:	10000	25000	50000	100000	500000	1000000							
R4	249	396290	300980	244480	198580	122540	99540	150	85	1500	2500	2200	6G	680000
	320	471190	358410	291120	236470	145920	118530	150	82	1500	2500	2200	6G	680000
	379	443030	383900	311830	253280	156280	126940	150	76	1500	2500	1600	6E	680000
	401	471180	383900	311830	253280	156280	126940	150	78	1500	2500	1600	6E	680000
	475	356250	305810	272430	249240	153790	124910	133	74	1500	2500	1200	6C	680000
	563	356280	305810	272430	249240	153790	124910	112	72	1500	2500	900	6B	680000
	655	336410	305810	272430	249240	153790	124910	91	69	1500	2500	900	6B	680000
	345	453930	344660	279970	227410	140330	114010	150	82	1500	2500	1600	6E	680000
	442	471160	383900	311830	253280	156280	126940	150	78	1500	2500	1600	6E	680000
	525	443030	383900	311830	253280	156280	126940	150	72	1500	2500	1200	6C	680000
	555	471190	383900	311830	253280	156280	126940	150	74	1500	2500	900	6B	680000
	657	356250	305810	272430	249240	153790	124910	96	71	1500	2500	900	6B	680000
	780	356280	305810	272430	249240	153790	124910	81	68	1500	2500	900	6B	680000
	906	336410	305810	272430	249240	153790	124910	66	64	1500	2500	900	6B	680000

321 R  446

655200 Nm

	i	M _{n2} [Nm]						P ₁	P _{TB}	n ₁	n _{1max}	M _b		M _{2max}
		n _{2-h}	n _{2-h}	n _{2-h}	n _{2-h}	n _{2-h}	n _{2-h}							
	1:	10000	25000	50000	100000	500000	1000000							
R4	221	374000	281300	226400	181800	111130	90320	150	113	1500	2500	2750	6K	934000
	288	447500	340100	268500	216800	133790	108740	150	106	1500	2500	2200	6G	934000
	347	506300	377100	307000	247800	152340	123900	150	101	1500	2500	2200	6G	934000
	370	528500	402100	317800	264200	159330	129500	150	101	1500	2500	2200	6G	934000
	446	587310	445420	366500	293970	181430	147460	150	97	1500	2500	2200	6G	934000
	529	536350	503040	410200	331430	204550	166260	150	91	1500	2500	1600	6E	934000
	306	401340	304660	247480	201030	124050	100790	150	110	1500	2500	2200	6G	934000
	399	483180	366770	297930	242020	149350	121350	150	101	1500	2500	2100	6G	934000
	481	550170	417600	339230	275560	170050	138170	132	96	1500	2500	1200	6C	934000
	512	575410	436760	354790	288200	177850	144510	125	97	1500	2500	1200	6C	934000
	617	655200	497290	403960	328150	202500	164540	120	92	1500	2500	1200	6C	934000
	732	536360	517290	420170	341290	210580	171050	113	86	1500	2500	900	6B	934000



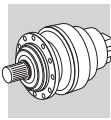

A6 DECLARATION OF CONFORMITY

The Declaration of Conformity, is the document which attests to the conformity of the product to Directive 2014/34/EU.

The validity of the Declaration is bound to observance of the instructions given in the User, Installation and Service Manual for safe use of the product throughout its service life.

This can be downloaded from www.bonfiglioli.com where the manual is available in PDF format in a number of languages.

The instructions regarding ambient conditions are of particular importance inasmuch as failure to observe them during operation of the product renders the certificate null and void. In case of doubt regarding the validity of the certificate of conformity, contact the BONFIGLIOLI RIDUTTORI technical department.



INDEX OF REVISIONS

BR_CAT_300M_IE2-IE3_ENG_R04_0	
	Description
...	Added availability of BXN and MXN electric motors.
...	Updated technical data of 6" hydraulic brakes.
44	Added "Long Term Stock" option.
262...383	Updated dimensions of electric motors in conjunction with the 300... 313M gearboxes.
512...631	"Electric motors" section updated.

2022.09.30

This publication supersedes and replaces any previous edition and revision. We reserve the right to implement modifications without notice. This catalogue cannot be reproduced, even partially, without prior consent.



We have a relentless commitment to excellence, innovation & sustainability. Our team creates, distributes and services world-class power transmission & drive solutions to keep the world in motion.

HEADQUARTERS

Bonfiglioli S.p.A

Registered office: Via Cav. Clementino Bonfiglioli, 1
40012 Calderara di Reno - Bologna (Italy)
Tel. +39 051 6473111

Head office: Via Isonzo, 65/67/69
40033 Casalecchio di Reno - Bologna (Italy)

